

**Grandstream Networks, Inc.**

126 Brookline Ave, 3rd Floor  
Boston, MA 02215. USA  
Tel : +1 (617) 566 - 9300

[www.grandstream.com](http://www.grandstream.com)



BE	BG	CZ	DK	DE	EE	IE	EL	LI
ES	FR	HR	IT	CY	LV	LT	LU	CH
HU	MT	NL	AT	PL	PT	RO	SI	TR
SK	FI	SE	NO	IS	UK	UK(NI)		

In the UK and EU member states, operation of 5150-5350 MHz is restricted to indoor use only.



For Certification, Warranty and RMA information, please visit [www.grandstream.com](http://www.grandstream.com)



**GWN7670**

Dual-Band Wi-Fi 7 Access Point

**Quick Installation Guide**

## **Content**

---

English.....	1
简体中文.....	7
Español.....	9
Français.....	15
Deutsch.....	21
Italiano.....	27
Português.....	33
Русский.....	39

## OVERVIEW

The GWN7670 is a next-generation enterprise-grade Wi-Fi 7 access point designed for SMB environments. It offers 2x2:2 MIMO technology on the 2.4GHz band and 2x2:2 MIMO on the 5GHz band, along with a sophisticated antenna design. Wi-Fi 7's 4096-QAM modulation delivers significant increases in data transfer rates, while MLO technology optimizes spectrum resource utilization to ensure a smooth experience for every user. To facilitate easy installation and management, the GWN7670 inherits the controller-less distributed network management design from the GWN766x series, with the controller embedded within the product's Web user interface. The GWN7670 is also supported by GDMS Networking and GWN Manager, Grandstream's cloud and on-premise Wi-Fi management platforms. It is ideal for voice-over-Wi-Fi deployments and offers seamless integration with Grandstream's Wi-Fi-capable IP phones. With support for advanced QoS, low-latency real-time applications, mesh networks, captive portals, Bluetooth location services with BLE 5.3, 256 concurrent clients per AP, and 2x 2.5 Gigabit network ports (one supporting PoE+), the GWN7670 is an ideal for medium-sized wireless network deployments with medium-to-high user density.

## PRECAUTIONS

- Do not attempt to open, disassemble, or modify the device.
- Do not expose this device to temperatures outside range of 0 °C to 45 °C for operating and -30 °C to 60 °C for storage.
- Do not expose the device to environments outside of the following humidity range: 10-90% RH (non-condensing).
- Do not power cycle your device during system boot up or firmware upgrade. You may corrupt firmware images and cause the unit to malfunction.

## PACKAGE CONTENTS

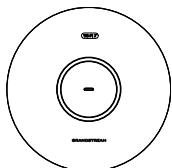

1x GWN7670 Access Point



1x Mounting Bracket

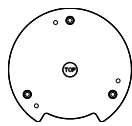

1x Ceiling Mounting Bracket

~1~

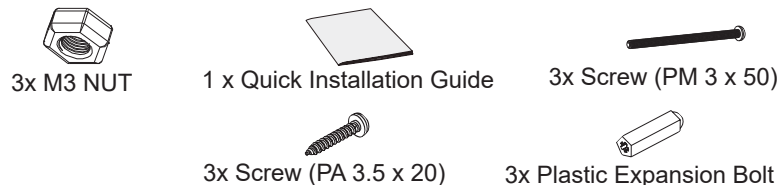

## GWN7670 PORTS

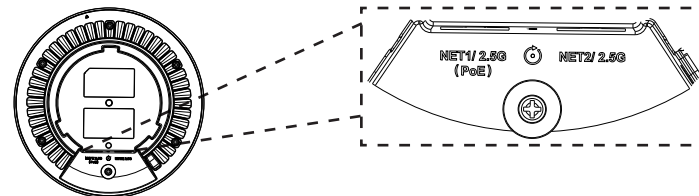

Port	Description
NET1/2.5G (PoE)	Ethernet RJ45 port (2.5Gbps) supporting PoE+.
NET2/2.5G	Ethernet RJ45 port (2.5Gbps).
RESET	Factory reset button. Hold for 7 seconds to reset to factory default.

## POWERING AND CONNECTING THE GWN7670

GWN7670 can be powered on using PoE+ switch using following steps:

**Step 1:** Plug a RJ45 Ethernet cable into the network port (NET1) of GWN7670.

**Step 2:** Plug the other end into the uplink port of the power over Ethernet (PoE+) switch.

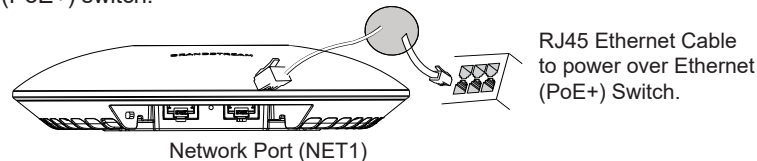

## HARDWARE INSTALLATION

GWN7670 can be mounted on the wall or ceiling, Please refer to the following steps for the appropriate installation.

~2~

## Wall Mount

1. Position the mounting bracket at the desired location on the wall with the arrow pointing up.
2. Use a pencil to mark the four mounting holes (screw holes DIA 5.5mm, reticle hole DIA 25mm).
3. If your Ethernet cable feeds through the wall, then cut or drill a circle approximately 18mm in diameter.
4. Insert screw anchors into the 5.5mm holes. Attach the mounting bracket to the wall by inserting the screws into the anchors.

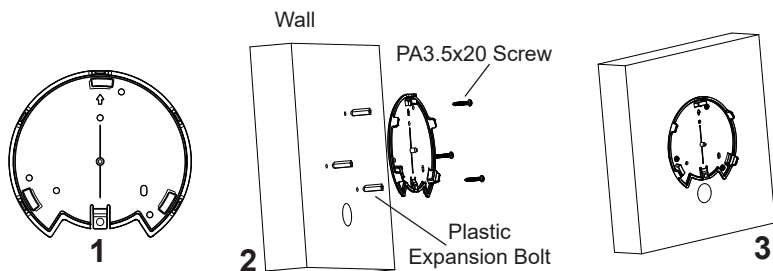

5. Connect the power cable and the ethernet cable (RJ45) to your GWN7670.
6. Align the arrow on the GWN7670 AP with the arrow on the locking tab of the mounting bracket and ensure that the device is firmly seated on the mounting bracket.
7. Turn the GWN7670 clockwise until it locks into place and fits the locking tab.

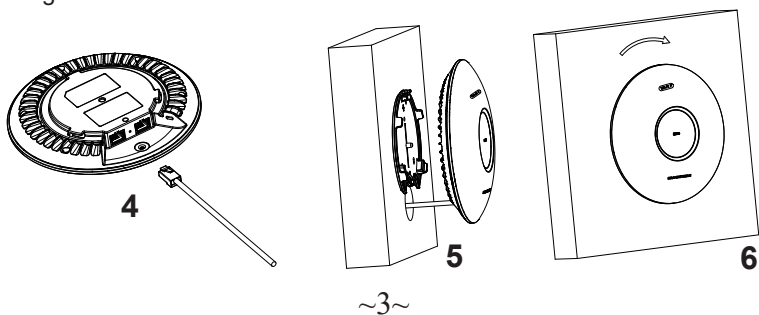

~3~

## Ceiling Mount

**Note:** Ceiling mounting is recommended for optimal coverage performance.

1. Remove the ceiling tile.
2. Place the ceiling backing plate in the center of the ceiling tile and mark the mounting screw holes (screw holes DIA 5.5mm, reticle hole DIA 25mm).
3. Insert the screws through the mounting bracket.

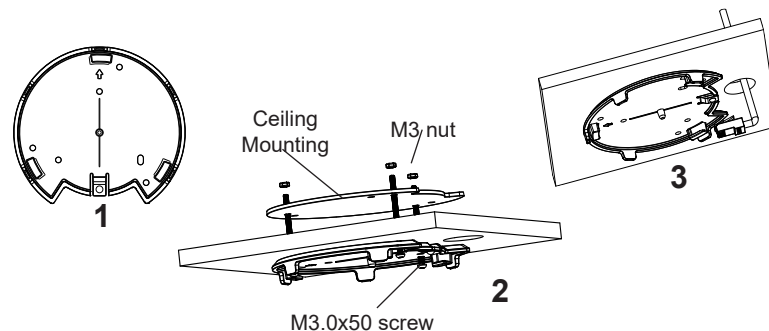

4. Connect the Ethernet cable (RJ45) to the correct ports of your GWN7670.
5. Align the arrow on the GWN7670 with the arrow on the locking tab of the mounting bracket and ensure that the device is firmly seated on the mounting bracket and connect the network and power cables.
6. Turn the GWN7670 clockwise until it locks into place and fits the locking tab.

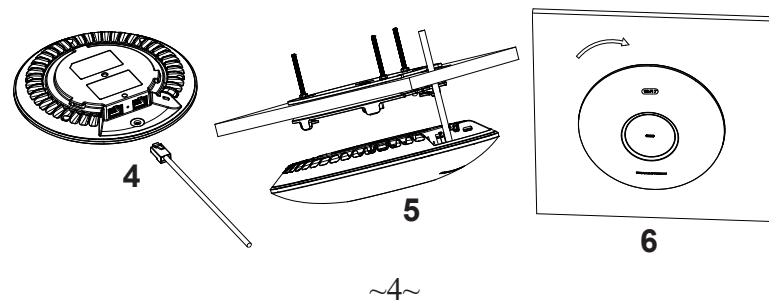

~4~



## CONNECT TO GWN7670 DEFAULT WI-FI NETWORK

GWN7670 can be used as standalone access point out of box, or after factory reset with Wi-Fi enabled by default.

After powering the GWN7670 and connecting it to the network, GWN7670 will broadcast a default SSID based on its MAC address **GWN[MAC's last 6 digits]** and a random password.

**Note:** GWN7670's default SSID and password information are printed on the MAC tag of the unit.

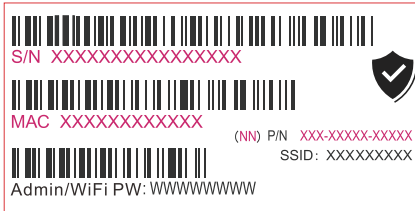

## ACCESSING THE CONFIGURATION INTERFACE

A computer connected to the GWN7670's SSID, or to the same network as the GWN7670 can discover and access its configuration interface using one of the below methods:

### Method 1: Discover GWN7670 using its MAC Address

1. Locate the MAC address on the MAC tag of the unit, which is on the underside of the device, or on the package.
2. From a computer connected to same network as the GWN7670, type in following address using GWN7670's MAC address on your browser **[https://gwn\\_<mac>.local](https://gwn_<mac>.local)**

Example: If a GWN7670 has the MAC address EC:74:D7:8C:4D:F8, this unit can be accessed by typing **[https://gwn\\_ec74d78c4df8.local](https://gwn_ec74d78c4df8.local)** on the browser.

### Method 2: Discover GWN7670 using GWN Discovery Tool

1. Download and install **GWN Discovery Tool** from the following link: <https://www.grandstream.com/tools/GWNDiscoveryTool.zip>

2. Open the GWN DiscoveryTool, and click on **Scan**.
3. The tool will discover all GWN76XX Access Points connected on the network showing their MAC and IP addresses.
4. Click on **Manage Device** to be redirected directly to the GWN7670's configuration interface, or type in manually the displayed IP address on your browser.
5. Enter username and password to login. (The default administrator username is "admin" and the default random password can be found at the sticker on the GWN7670).

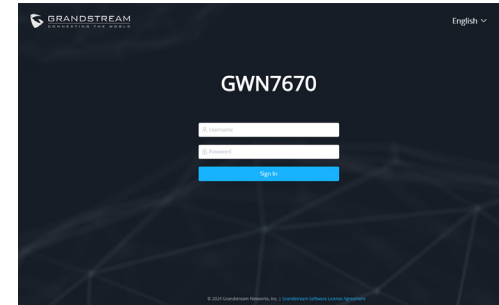

### Notes:

- Make sure that the GWN7670 is not already paired with another GWN76xx Access Point as slave, GWN Router, GCC device or GDMS Networking Cloud, otherwise the configuration interface cannot be accessed.
- If the GWN7670 is already paired, make sure to unpair it first, then do a factory reset.
- It is customer's responsibility to ensure compliance with local regulations for frequency bands, transmit power and others.
- To manage GWN7670 over cloud, please refer to <https://www.gdms.cloud>.

The GNU GPL license terms are incorporated into the device firmware and can be accessed via the Web user interface of the device at [my\\_device\\_ip/gpl\\_license](https://www.grandstream.com/legal/open-source-software). It can also be accessed here: <https://www.grandstream.com/legal/open-source-software>  
To obtain a CD with GPL source code information please submit a written request to [info@grandstream.com](mailto:info@grandstream.com)

Refer to online documents and FAQ for more detailed information:

<https://www.grandstream.com/our-products>

### 概述

GWN7670是专为中小企业环境设计的下一代企业级Wi-Fi 7接入点。它提供双频2.4G 2x2:2和5G 2x2:2 MIMO技术精密的天线设计。使用4096 QAM调制，Wi-Fi7实现了数据传输速率的显著提高。MLO技术优化了频谱资源利用率，确保每个用户都能获得流畅的体验。为了便于安装和管理，GWN7670继承了GWN766x系列的无控制器分布式网络管理设计，将控制器嵌入到了产品的Web用户界面中。GWN7670既支持使用无控制器的分布式网络管理设计，内嵌AC控制器（嵌入Web用户界面中），也支持GDMS Networking系统以实现大规模的部署管理。支持高级QoS，低延迟实时应用，网状网络，专用门户，蓝牙定位服务(BLE 5.3)，每个AP 256个并发客户端和2个2.5千兆网络端口(一个支持PoE+)。成为了中大企业无线网络部署的理想选择。

### 注意事项

- 不要尝试打开，拆解或修改设备。
- 不要将本设备暴露在温度超出0℃至45℃的工作环境或超出-30℃至60℃的储存环境。
- 不要将本设备暴露在环境湿度如下范围以外：10-90%RH（无冷凝）
- 系统启动或固件升级期间不要中断电源。这可能会损坏设备固件，并导致设备故障。

### 包装内容

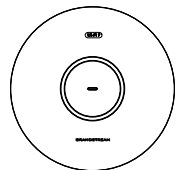

1x GWN7670 无线热点

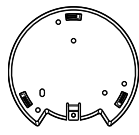

1x 安装支架

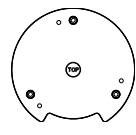

1x 天花板安装支架



3x 螺丝 (PM 3 × 50)



3x 螺丝 (PA 3.5 × 20)



3x 塑料膨胀螺栓



3x M3螺帽



1x 快速安装手册

### GWN7670 端口

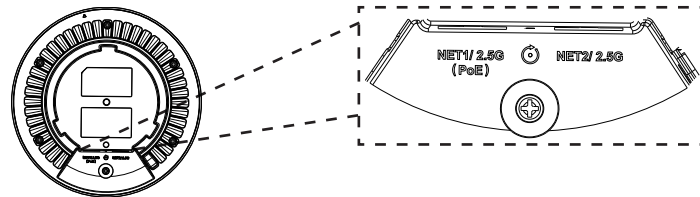

端口	描述
NET1/2.5G (PoE)	以太网RJ45端口 (2.5Gbps)。支持PoE/PoE+。
NET2/2.5G	以太网RJ45端口 (2.5Gbps)。
RESET	恢复出厂设置按钮。 按7秒恢复出厂默认设置。

GNU GPL许可条款已包含在设备固件中，可以通过设备的Web用户界面 my\_device\_ip/gpl\_license 进行访问。也可以通过以下链接访问：<https://www.grandstream.com/legal/open-source-software> 如果需要包含GPL源代码信息的CD，请发邮件到 [info@grandstream.com](mailto:info@grandstream.com) 提交请求。

欲获取详细的话机使用信息，请在以下链接中下载GWN7670用户手册。  
<https://www.grandstream.com/support>

## RESUMEN

El GWN7670 es un punto de acceso Wi-Fi 7 de última generación de nivel empresarial diseñado para entornos de PYMES. Ofrece tecnología MIMO 2x2:2 en la banda de 2,4 GHz y MIMO 2x2:2 en la banda de 5 GHz, junto con un diseño de antena muy sofisticado. La modulación 4096-QAM de Wi-Fi 7 ofrece aumentos significativos en las velocidades de transferencia de datos, mientras que la tecnología MLO optimiza la utilización de los recursos del espectro para garantizar una experiencia fluida para todos los usuarios. Para facilitar la instalación y la gestión, el GWN7670 hereda el diseño de gestión de red distribuida sin controlador de la serie GWN766x, con el controlador integrado en la interfaz de usuario web del producto. El GWN7670 también es compatible con los sistemas de gestión en la nube GDMS Networking y gestión local GWN Manager de Grandstream. Es el punto de acceso Wi-Fi ideal para implementaciones de voz sobre Wi-Fi y ofrece una conexión perfecta a teléfonos IP con conectividad Wi-Fi de Grandstream. Con soporte para QoS avanzado, aplicaciones en tiempo real de baja latencia, redes mesh, portales cautivos, servicios de ubicación Bluetooth con BLE 5.3, 256 clientes simultáneos por AP y 2 puertos de red de 2,5 Gigabit (uno compatible con PoE+), el GWN7670 es un punto de acceso Wi-Fi ideal para implementaciones de redes inalámbricas con densidad de usuarios media a alta.

## PRECAUCIONES

- No intente abrir, desarmar o modificar el dispositivo.
- No exponga este dispositivo a temperaturas fuera del rango de 0 °C a 45 °C en funcionamiento y desde -30 °C a 60 °C cuando se encuentre almacenado.
- No exponga el GWN7670 a entornos fuera del siguiente rango de humedad: 10-90% RH (sin condensación).
- No apague su GWN7670 durante el reinicio del sistema o actualización de Firmware. Puede corromper la imagen del firmware y causar un mal funcionamiento de la unidad.

## CONTENIDO DEL PAQUETE

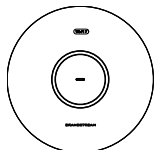

1x Punto de Acceso GWN7670



1x Soporte de Montaje



1x Soporte para montaje en techo



3x M3 NUT



1x Guía de instalación Rápida



3x Tornillos (PM 3x50)



3x Tornillos (PA 3.5X20)



3x Pernos de expansión de plástico

## PUERTOS GWN7670

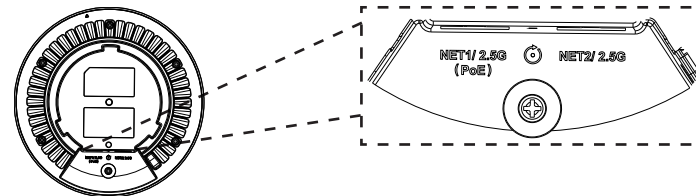

Puerto	Descripción
NET1/2.5G (PoE)	Puerto Ethernet RJ45 (2.5Gbps) , con soporte de PoE/PoE+.
NET2/2.5G	Ethernet RJ45 port (2.5Gbps).
RESET	Botón de reinicio de fábrica. Presione por 7 segundos para llevar a los ajustes de fábrica.

## ENCENDIENDO Y CONECTANDO EL GWN7670

El GWN7670 puede ser alimentado usando un switch PoE/PoE+ por medio de los siguientes pasos:

**Paso 1:** Conecte un cable Ethernet RJ45 en el puerto de red (NET1) del GWN7670.

**Paso 2:** Conecte el otro extremo del cable en el puerto del switch (PoE/PoE+).

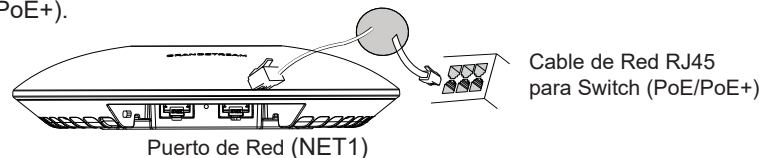

## INSTALACIÓN DE HARDWARE

El GWN7670 puede ser montado en la pared o techo, por favor consulte los siguientes pasos para la instalación apropiada.

## Montura de Pared

1. Situe el soporte de montaje en la locación deseada sobre la pared con la flecha apuntando hacia arriba.
2. Use un lápiz para marcar los cuatro agujeros de montaje (agujeros de los tornillos DIA 5.5mm, agujero retícula DIA 25mm).
3. Si su cable ethernet tiene que pasar a través de una pared, se debe perforar un círculo de aproximadamente 18 mm de diámetro sobre la misma.
4. Inserte los anclajes de tornillo en los orificios de 5.5mm. Fije el soporte de montaje a la pared mediante la inserción de los tornillos en los anclajes.

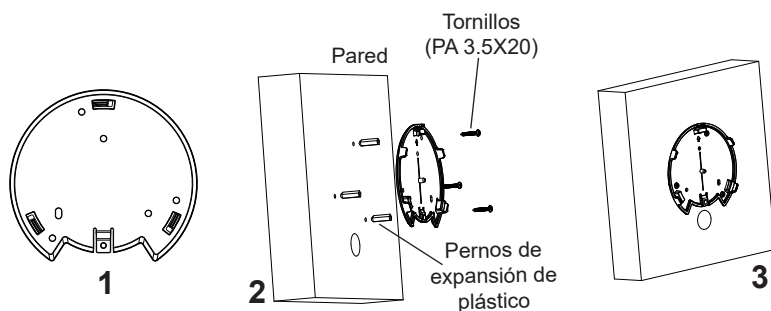

5. Conecte el cable de ethernet (RJ45) al puerto correcto de su GWN7670.
6. Conecte el cable de alimentación y el cable ethernet (RJ45) a los puertos correspondientes de su GWN7670.
7. Gire el GWN7670 al sentido del reloj hasta que encaje en su lugar y se ajuste la lengüeta de fijación.

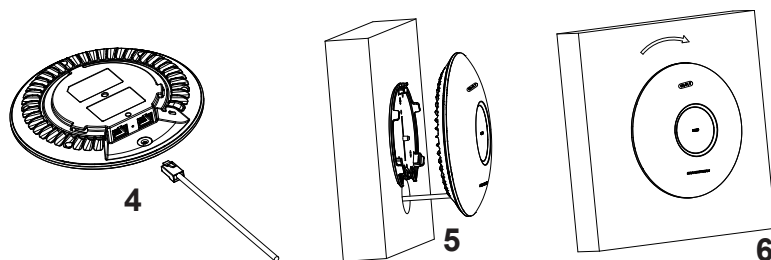

## Montura de Techo

**Nota:** Se recomienda un montaje en el techo para obtener un óptimo rendimiento de cobertura.

1. Retire la losa del techo.
2. Coloque la placa de soporte de techo en el centro de la placa de techo y marque los orificios de los tornillos de montaje (orificios de los tornillos de 5.5mm DIA, retícula diámetro del agujero 25mm).
3. Inserte los tornillos a través del soporte de montaje.

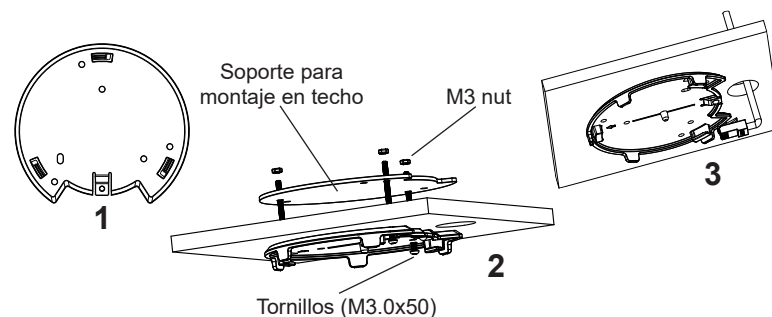

4. Conecte el cable de ethernet (RJ45) al puerto correcto de su GWN7670.
5. Alinee la flecha sobre el GWN7670 AP con la flecha en la lengüeta de bloqueo del soporte de montaje y asegúrese de que su GWN7670 esté firmemente asentado en el soporte de montaje y conecte los cables de red y alimentación.
6. Gire el GWN7670 al sentido del reloj hasta que encaje en su lugar y se ajuste la lengüeta de fijación.

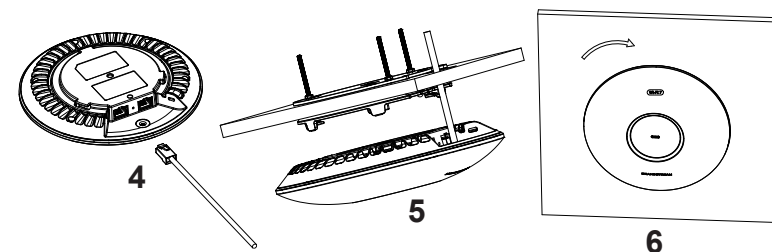

## CONECTAR AL GWN7670 CON LA RED Wi-Fi PREDETERMINADA

El GWN7670 puede ser usado como punto de acceso autónomo al sacarlo de caja, o después del restablecimiento de fábrica con Wi-Fi activado por defecto.

Después de encender el GWN7670 y establecer la conexión a la red, el GWN7670 emitirá un SSID predeterminado basado en su dirección MAC **GWN[6 últimos dígitos del MAC]** y una contraseña aleatoria.

**Nota:** La información del SSID y contraseña por defecto del GWN7670 están impresas en la etiqueta MAC de la unidad.

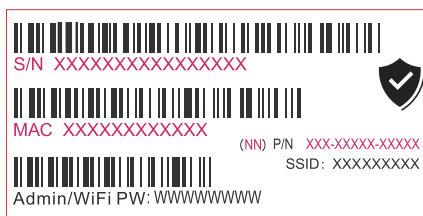

## ACCESO A LA INTERFAZ DE CONFIGURACIÓN

Un ordenador conectado al SSID del GWN7670, o en la misma red que el GWN7670 puede descubrir y acceder a su interfaz de configuración usando uno de los siguientes métodos:

### Método 1: Descubrir GWN7670 utilizando su dirección MAC

1. Localice la dirección MAC del equipo que esta en la etiqueta de la unidad, ubicada en la parte posterior del equipo o en la caja.
2. Desde un ordenador conectado a la misma red del GWN7670, escriba la siguiente dirección utilizando la dirección MAC del GWN7670 en su navegador **[https://gwn\\_<MAC>.local](https://gwn_<MAC>.local)**

**Ejemplo:** De un GWN7670 que tenga la dirección MAC EC:74:D7:8C:4D:F8, esta unidad se puede acceder escribiendo en el navegador **[https://gwn\\_ec74d78c4df8.local](https://gwn_ec74d78c4df8.local)** en el navegador.

### Método 2: Descubrir el GWN7670 utilizando la herramienta GWNDiscoveryTool

1. Descargar e instalar el **GWNDiscoveryTool** desde el siguiente enlace: <https://www.grandstream.com/tools/GWNDiscoveryTool.zip>

2. Abrir la herramienta GWNDiscoveryTool, y haga clic en **Escanear**.
3. La herramienta descubrirá todos los Puntos de Acceso GWN7670 conectados a la red mostrando sus direcciones MAC's e IP's.
4. Haga clic en **Administrar dispositivos** para que sea redirigido directamente a la interfaz de configuración de la GWN7670, o escriba manualmente la dirección IP que se muestra en su navegador.
5. Introduzca el nombre de usuario y la contraseña para iniciar sesión. (El nombre de usuario de administrador predeterminado es "admin" y la contraseña aleatoria predeterminada puede ser encontrada en la etiqueta del GWN7670).

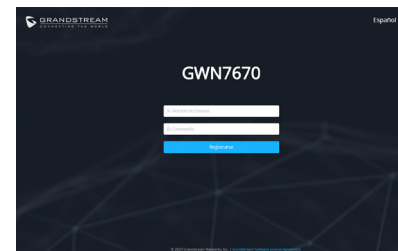

### Notas:

- *Asegúrese de que el GWN7670 no esté emparejado con otro punto de acceso GWN76xx como esclavo, enrutador GWN, dispositivo GCC o con la plataforma en la nube GDMS Networking; de lo contrario, no se podrá acceder a la interfaz de configuración.*
- *Si el GWN7670 ya está enlazado, asegúrese de eliminar el enlace primero y luego realice un restablecimiento de fábrica.*
- *Es responsabilidad del cliente asegurarse del cumplimiento con las regulaciones locales para bandas de frecuencia, potencia de transmisión y otros.*
- *Para administrar el GWN7670 a través de la nube, consulte el siguiente link <https://www.gdms.cloud>*

Los términos de licencia GNU GPL son incorporados en el firmware del dispositivo y puede ser accedido a través de la interfaz de usuario Web del dispositivo en `ip_de_mi_dispositivo/gpl_license`. También puede ser accedido aquí: <https://www.grandstream.com/legal/open-source-software>  
Para obtener un CD con la información del código fuente GPL, por favor, remita una solicitud escrita a [info@grandstream.com](mailto:info@grandstream.com)

Para obtener el manual de usuario, favor haga click aquí: <https://www.grandstream.com/our-products>

## PRESENTATION

Le GWN7670 est un point d'accès Wi-Fi 7 de nouvelle génération destiné aux entreprises et conçu pour les environnements PME. Il offre la technologie 2x2:2 MIMO sur la bande 2,4 GHz et 2x2:2 MIMO sur la bande 5 GHz, ainsi qu'une conception d'antenne sophistiquée. La modulation 4096-QAM du Wi-Fi 7 permet d'augmenter considérablement les taux de transfert de données, tandis que la technologie MLO optimise l'utilisation des ressources du spectre pour garantir une expérience fluide à chaque utilisateur. Pour faciliter l'installation et la gestion, le GWN7670 hérite de la conception de gestion de réseau distribué sans contrôleur de la série GWN766x, avec le contrôleur intégré dans l'interface utilisateur Web du produit. Le GWN7670 est également pris en charge par GDMS Networking et GWN Manager, les plates-formes de gestion Wi-Fi en nuage et sur site de Grandstream. Il est idéal pour les déploiements de voix sur Wi-Fi et offre une intégration transparente avec les téléphones IP Wi-Fi de Grandstream. Prenant en charge la qualité de service avancée, les applications en temps réel à faible latence, les réseaux maillés, les portails captifs, les services de localisation Bluetooth avec BLE 5.3, 256 clients simultanés par point d'accès et deux ports réseau de 2,5 gigabits (dont un prenant en charge PoE+), le GWN7670 est idéal pour les déploiements de réseaux sans fil de taille moyenne avec une densité d'utilisateurs moyenne à élevée.

## PRECAUTIONS

- Ne pas tenter d'ouvrir, de désassembler, ou de modifier le dispositif.
- Ne pas exposer cet appareil à des températures situées hors de la plage de 0 °C à 45 °C en opération et -30 °C à 60 °C en stockage.
- Ne pas exposer cet appareil à un environnement avec humidité hors de la plage de 10-90% RH (sans condensation).
- Ne pas éteindre le GWN7670 pendant le démarrage du système ou la mise à jour du firmware. Cela risque de rompre l'image du firmware et en conséquence rendre l'unité inutilisable.

## CONTENU DU PACK

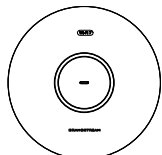

1x Point d'Accès GWN7670

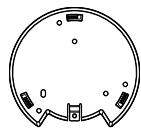

1x Support de montage

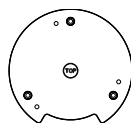

1x Support de montage mural

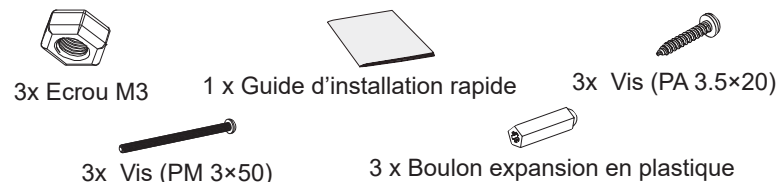

## PORTS DU GWN7670

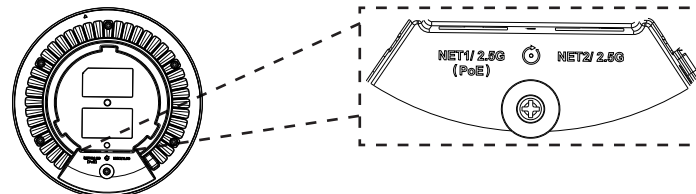

Port	Description
NET1/2.5G(PoE)	Port Ethernet RJ45 (2.5Gbps), supportant PoE/PoE+.
NET2/2.5G	Port Ethernet RJ45 (2.5Gbps).
RESET	Bouton de réinitialisation. Appuyer pendant 7 secondes pour réinitialiser les paramètres d'usine.

## ALIMENTATION ET RACCORDEMENT DU GWN7670

GWN7670 peut être alimenté avec un switch PoE/PoE+ en suivant les étapes ci-dessous.

**Étape 1:** Brancher un câble Ethernet RJ45 au port réseau (NET1) du GWN7670.

**Étape 2:** Brancher l'autre extrémité au port Uplink du Switch PoE/PoE+.

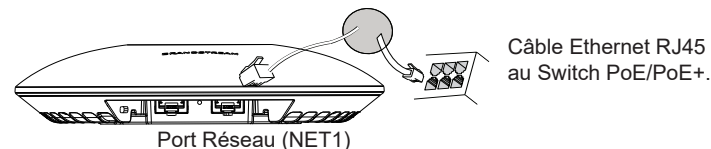

## INSTALLATION PHYSIQUE

GWN7670 peut être monté sur le mur ou le plafond. Veuillez se référer aux étapes suivantes pour l'installation appropriée.



## Montage Mural

1. Placer le support de montage à l'endroit désiré sur le mur avec la flèche pointant vers le haut.
2. Utiliser un crayon pour marquer les quatre trous de montage (trous de vis DIA 5.5mm, trou de réticule DIA 25mm).
3. Si votre câble Ethernet traverse le mur, couper ou percer un cercle d'environ 18 mm de diamètre.
4. Insérer les vis d'ancrages dans les trous 5.5 mm. Fixer le support de montage au mur en insérant les vis dans les ancres.

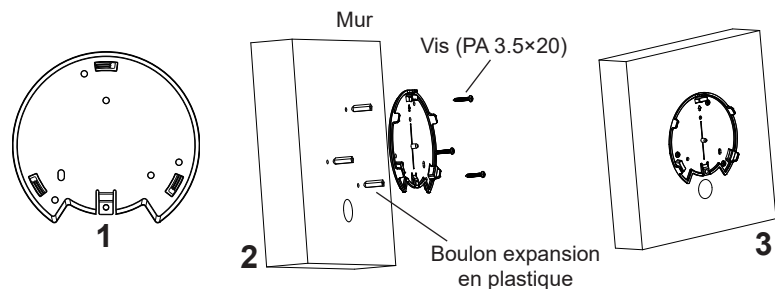

5. Brancher le câble Ethernet (RJ45) aux ports appropriés de votre GWN7670.
6. Aligner la flèche sur le GWN7670 avec la flèche sur la languette de verrouillage du support de montage et veiller à ce que votre GWN7670 est bien en place sur le support de montage.
7. Pivoter le GWN7670 dans le sens horaire jusqu'à ce qu'il se verrouille en place et correspond à la languette de verrouillage.

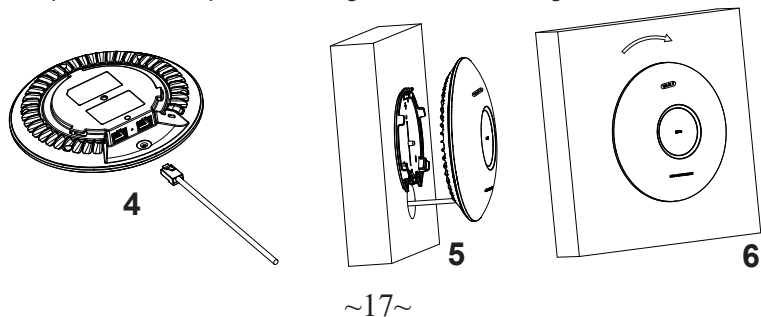

~17~

## Montage au Plafond

**Note:** Le montage au plafond est recommandé pour une couverture optimale.

1. Retirer la dalle de plafond.
2. Placer la plaque du support de plafond dans le centre de la dalle de plafond et marquer les trous des vis de montage (les trous de vis DIA 5.5mm, trou réticule DIA 25mm).
3. Insérer les vis dans le support de montage.

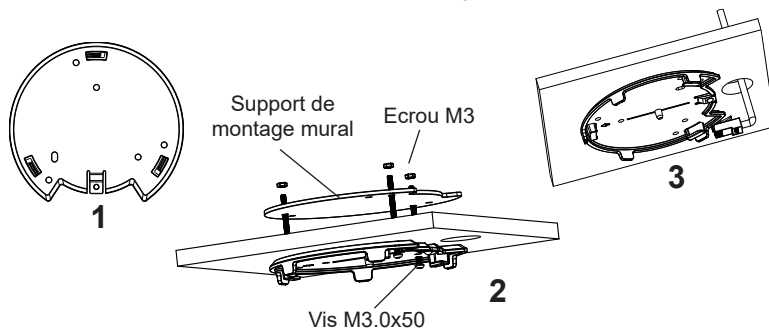

4. Brancher le câble Ethernet (RJ45) aux ports appropriés de votre GWN7670.
5. Pivoter le GWN7670 dans le sens horaire jusqu'à ce qu'il se verrouille en place et correspond à la languette de verrouillage.
6. Aligner la flèche sur le GWN7670 avec la flèche sur la languette de verrouillage du support de montage et veiller à ce que votre GWN7670 est bien en place sur le support de montage et de connecter les câbles réseau et d'alimentation.

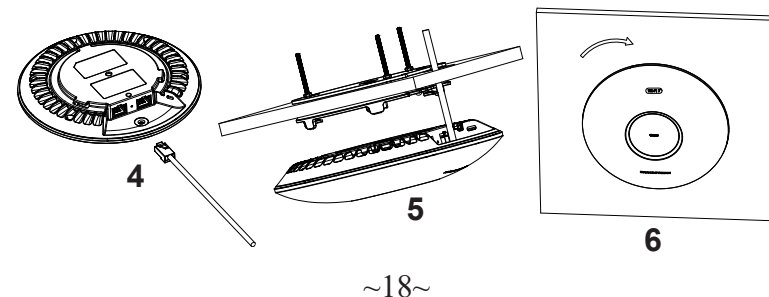

~18~

## CONNEXION AU RESEAU WI-FI PAR DEFAULT DU GWN7670

Le GWN7670 peut être utilisé comme point d'accès autonome avec Wi-Fi activé par défaut lors de la première utilisation, ou après réinitialisation aux paramètres d'usine.

Après la mise sous tension du GWN7670 et connexion au réseau, le GWN7670 diffusera un SSID par défaut en fonction de son adresse MAC **GWN[6 derniers chiffres du MAC]** et un mot de passe aléatoire.

**Remarque:** Le SSID et mot de passe par défaut du GWN7670 sont imprimés sur l'étiquette MAC de l'unité.



## ACCEDER A L'INTERFACE DE CONFIGURATION

Un ordinateur connecté au SSID du GWN7670, ou au même réseau que le GWN7670 peut découvrir et accéder à son interface de configuration en utilisant une des méthodes suivantes:

### Méthode 1: Détecter le GWN7670 via son adresse MAC

1. Localiser l'adresse MAC sur l'étiquette MAC de l'unité située à la face arrière de l'unité, ou sur l'emballage.
2. A partir d'un ordinateur connecté au même réseau que le GWN7670, tapez l'adresse suivante en utilisant l'adresse MAC du GWN7670 sur votre navigateur: **[https://gwn\\_<mac>.local](https://gwn_<mac>.local)**

**Exemple:** Un GWN7670 avec l'adresse MAC EC:74:D7:8C:4D:F8 peut être accessible à partir d'un navigateur web en utilisant l'URL: **[https://gwn\\_ec74d78c4df8.local](https://gwn_ec74d78c4df8.local)**

### Méthode 2: Détecter le GWN7670 via GWNDISCOVERYTOOL

1. Télécharger et installer **GWNDISCOVERYTOOL** à partir du lien suivant: **<https://www.grandstream.com/tools/GWNDISCOVERYTOOL.zip>**

2. Ouvrir le **GWNDISCOVERYTOOL**, et cliquer sur **Scan**.
3. L'outil permettra de découvrir tous les points d'accès GWN7670 connectés sur le réseau montrant leurs adresses MAC et IP.
4. Cliquer sur **Manage Device** pour être redirigé directement à l'interface de configuration du GWN7670, ou saisir manuellement sur votre navigateur l'adresse IP affichée.
5. Entree le nom d'utilisateur et mot de passe pour vous connecter. (Le nom d'utilisateur de l'administrateur par défaut est « admin » et le mot de passe aléatoire par défaut peut être trouvé sur l'autocollant du GWN7670).

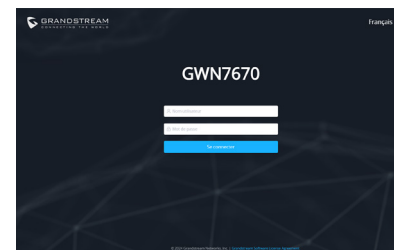

### Notes :

- Assurez-vous que le GWN7670 n'est pas déjà associé à un autre point d'accès GWN76xx en tant qu'esclave, à un routeur GWN, à un appareil GCC ou à un compte GDMS Networking Cloud, sinon l'interface de configuration ne sera pas disponible.
- Si le GWN7670 est déjà associé, assurez-vous de le dissocier d'abord, puis faire une réinitialisation aux paramètres d'usine.
- Il est de la responsabilité du client de s'assurer de la conformité aux réglementations locales concernant les bandes de fréquence, la puissance de transmission et d'autres.
- Pour gérer le GWN7670 via cloud, veuillez se référer à <https://www.gdms.cloud>

Les termes de la licence GNU GPL sont incorporés dans le firmware du périphérique et sont accessibles via l'interface utilisateur Web du périphérique à l'adresse `my_device_ip / gpl_license`. Vous pouvez également y accéder ici: <https://www.grandstream.com/legal/open-source-software>  
Pour obtenir un CD contenant les informations du code source GPL, veuillez envoyer une demande écrite à [info@grandstream.com](mailto:info@grandstream.com)

Pour plus de détails, veuillez consulter le manuel d'utilisation sur: <https://www.grandstream.com/our-products>



## ÜBERSICHT

Der GWN7670 ist ein Wi-Fi 7-Zugangspunkt der nächsten Generation, der für KMU-Umgebungen entwickelt wurde. Er bietet 2x2:2 MIMO-Technologie auf dem 2,4-GHz-Band und 2x2:2 MIMO auf dem 5-GHz-Band sowie ein ausgeklügeltes Antennendesign. Die 4096-QAM-Modulation von Wi-Fi 7 sorgt für deutlich höhere Datenübertragungsraten, während die MLO-Technologie die Nutzung der Spektrumsressourcen optimiert, um ein reibungsloses Erlebnis für jeden Benutzer zu gewährleisten. Für eine einfache Installation und Verwaltung übernimmt der GWN7670 das verteilte Netzwerkmanagement ohne Controller der GWN766x-Serie, wobei der Controller in die Web-Benutzeroberfläche des Produkts eingebettet ist. Der GWN7670 wird auch von GDMS Networking und GWN Manager unterstützt, Grandstreams Cloud- und On-Premise-Wi-Fi-Management-Plattform. Er ist der ideale Wi-Fi AP für Voice-over-Wi-Fi-Bereitstellungen und bietet eine nahtlose Verbindung mit den Wi-Fi-fähigen IP-Telefonen von Grandstream. Mit Unterstützung für erweiterte QoS, Echtzeitanwendungen mit niedriger Latenz, Mesh-Netzwerke, Captive Portals, Bluetooth-Standortdienste mit BLE 5.3, 256 gleichzeitige Clients pro ZP und 2 x 2,5-Gigabit-Netzwerkanschlüsse (einer davon mit PoE+-Unterstützung). ist der GWN7670 ein idealer Wi-Fi-Zugangspunkt für mittlere drahtlose Netzwerkimplementierungen mit mittlerer bis hoher Benutzerdichte.

## SICHERHEITSHINWEISE

- Das Produkt darf nicht geöffnet, zerlegt oder verändert werden.
- Bitte beachten Sie die zulässigen Temperaturbereiche für Nutzung (0 °C bis 45 °C) und Lagerung (-30 °C bis 60 °C).
- Das Produkt darf nur in Umgebungen mit einem relativen Luftfeuchtebereichs von 10% bis 90% (nicht kondensierend) genutzt werden.
- Die Stromversorgung darf während des Start- bzw. Upgradevorgangs nicht unterbrochen werden. Dies kann die Firmware beschädigen und zu unerwünschten Fehlfunktionen führen.

## VERPACKUNGSGEHALT



GWN7670 Access Point



1x Montagewinkel

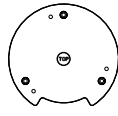

1x Halterung für die Deckenmontage

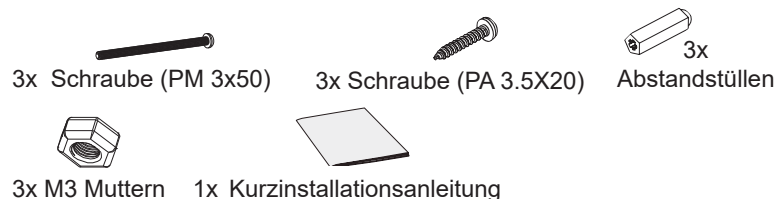

## GWN7670 ANSCHLÜSSE

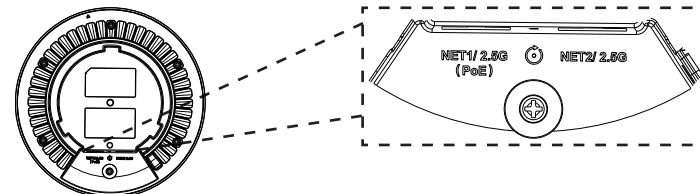

Port	Beschreibung
NET1/2.5G (PoE)	RJ45 Ethernet-Anschluß (2.5Gbps), mit PoE/PoE+ Unterstützung
NET2/2.5G	RJ45 Ethernet-Anschluß (2.5Gbps).
RESET	Reset-Taste. Drücken Sie die Taste min. 7 Sekunden, um das Produkt auf Werkseinstellung zurückzusetzen.

## STROMVERSORGUNG UND ANSCHLUß DES GWN7670

Der GWN7670 kann wie nachfolgend beschrieben über PoE/PoE+ mit Strom versorgt werden:

1. Stecken Sie das RJ45 Ethernetkabel in den Netzwerk-Port (NET1) am GWN7670.
2. Stecken Sie das andere Ende des Netzwerkkabels in den passenden Port am PoE/PoE+ Switch.

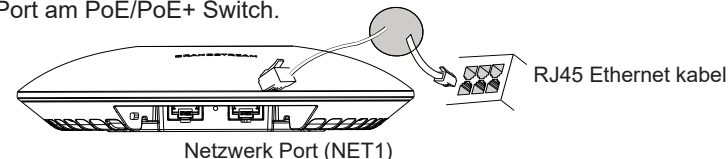

## HARDWARE-INSTALLATION

Der GWN7670 kann sowohl an der Wand, als auch an der Decke montiert werden. Beide Varianten sind nachfolgend beschrieben.

## Wandmontage

1. Positionieren der Halterung an der gewünschten Stelle mit dem Richtungspfeil nach oben.
2. Markieren der Montagelöcher mit einem Stift. (Lochdurchmesser 5,5mm, Lochkreisradius 25mm).
3. Bohren Sie bitte ein Loch mit einen Durchmesser von ca. 18mm, um das Ethernetkabel durch eine Wand zu führen.
4. Stecken Sie die Montagdübel in die gebohrten 5,5mm Löcher. Halten Sie die Halterung über die Montagelöcher, stecken Sie die Schrauben in die Dübel und ziehen Sie diese fest.

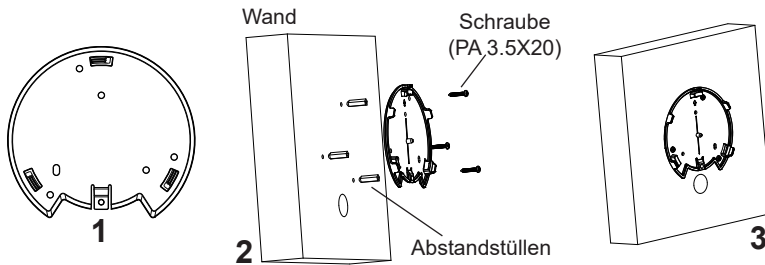

5. Stecken Sie das Ethernet-Kabel (RJ45) in den Netzwerk-Port des GWN7670.
5. Zur Montage des GWN7670 AP muss der Richtungspfeil am Access-Point mit dem Richtungspfeil an der montierten Halterung übereinstimmen, die Geräte passen nur so korrekt zusammen.
6. Drehen Sie nun den GWN7670 Access-Point im Uhrzeigersinn bis dieser fest in der Halterung sitzt.

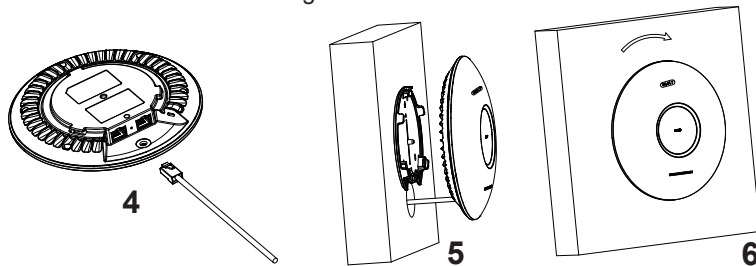

## Deckenmontage

**Bemerkung:** Wir empfehlen das Produkt an der Decke zu montieren, um eine optimale Leistung und Ausleuchtung zu erzielen.

1. Nehmen Sie die Deckenplatte heraus.
2. Platzieren Sie den Access-Point in der Plattenmitte und markieren Sie die Montagelöcher mit einem Stift. (Lochdurchmesser 5,5mm, Lochkreisradius 25mm).
3. Befestigen Sie die Halterung mit den beiliegenden Schrauben.

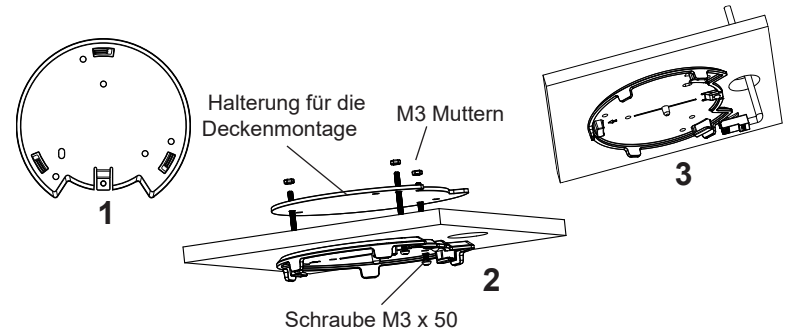

4. Stecken Sie das Ethernet-Kabel (RJ45) in den Netzwerk-Port des GWN7670.
5. Zur Montage des GWN7670 AP muss der Richtungspfeil am Access-Point mit dem Richtungspfeil an der montierten Halterung übereinstimmen, die Geräte passen nur so korrekt zusammen.
6. Drehen Sie nun den GWN7670 Access-Point im Uhrzeigersinn bis dieser fest in der Halterung sitzt.

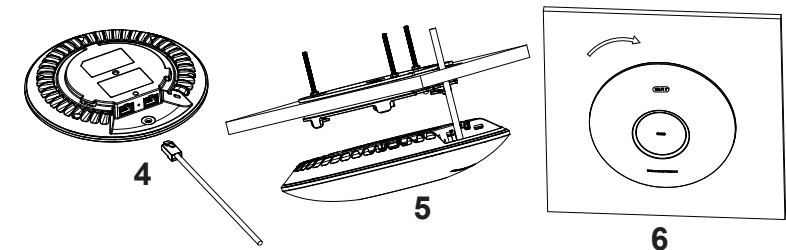

## VERBINDEN SIE SICH MIT DEM VOREINGESTELLTEN WI-FI-NETZWERK DES GWN7670

Der GWN7670 kann als "Stand-alone" Access-Point direkt verwendet werden - oder nach einem Reset auf Werkseinstellungen - Wi-Fi ist in der Grundeinstellung immer aktiviert.

Sobald der GWN7670 mit Strom versorgt und an das Netzwerk angeschlossen ist, sendet der Access-Point eine voreingestellte SSID, diese basiert auf der MAC Adresse des Gerätes (die letzten sechs Ziffern/Buchstaben der MAC Adresse) sowie einem Zufallspasswort.

**HINWEIS:** Die SSID und Passwortinformationen befinden sich auf dem MAC-Adressen Aufkleber auf der Rückseite des Gerätes.



## ZUGANG ZUR KONFIGURATIONSSCHNITTSTELLE

Sobald ein Computer zur SSID des GWN7670 oder im selben Netzwerk angeschlossen ist, kann nach ihm gesucht werden um so zur Konfigurationsschnittstelle zu gelangen:

### Methode 1: Suche nach dem GWN7670 via MAC Adresse

1. Die MAC-Adresse des Gerätes befindet sich entweder auch dem Aufkleber auf der Unterseite des Gerätes, oder auf dem Aufkleber an der Verpackung.

2. Nutzen Sie einen Computer im selben Netzwerk wie der GWN7670 geben Sie die MAC Adresse in den Internetbrowser ein, nutzen Sie bitte nur dieses Format: **https://gwn\_<mac>.local**

**Beispiel:** Lautet die MAC Adresse des GWN7670z.B. 00:0B:82:8B:4E:28 dann tippen Sie diese bitte wie folgt in die Adresszeile des Browsers: **https://gwn\_000b828b4e28.local**

### Methode 2: Suche nach dem GWN7670 via GWNDiscovery-Tool

1. Laden Sie das GWNDiscoveryTool von der Grandstream Support-Website: <https://www.grandstream.com/tools/GWNDiscoveryTool.zip>

2. Öffnen Sie das GWNDiscoveryTool und klicken Sie auf **Scan**.
3. Das Tool (Werkzeug) wird alle im Netz installierten GWN7670 Access-Points finden und deren MAC Adresse sowie die jeweilige IP Adresse anzeigen.
4. Klicken Sie auf **Manage Device** (Gerät verwalten) um direkt auf die Konfigurationsseite des GWN7670 zu gelangen oder tippen Sie einfach die angezeigte IP Adresse in die Adresszeile des Browsers.
5. Geben Sie Benutzername und Passwort ein. Der voreingestellte Administrator-Benutzername lautet "admin", das Zufallspasswort befindet sich auf dem Produktaufkleber auf der Rückseite der GWN7670.

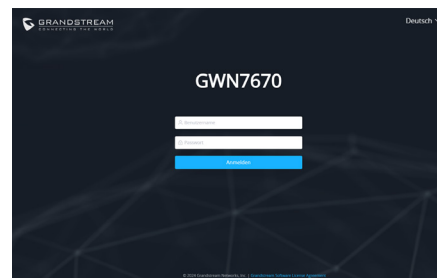

### Bemerkung:

- Stellen Sie sicher, dass der GWN7670 nicht bereits mit einem anderen GWN76xx-Zugangspunkt als Slave, einem GWN-Router, einem GCC-Gerät oder einer GDMS Networking Cloud gepaart gekoppelt ist, da anderenfalls kein Zugriff auf die Konfigurationsschnittstelle möglich ist.
- Ist der GWN7670 bereits zugeordnet, sicherstellen, diese Zuordnung zu lösen und den Access Point auf die Werkseinstellungen zurückzusetzen.
- Für die Einhaltung der im jeweiligen Anwendungsland gültigen Regularien für Frequenzen, Übertragungsbandbreite, Sendeleistung usw. ist der Anwender verantwortlich.
- Um einen oder mehrere GWN7670 über die Cloud zu verwalten, wechseln Sie bitte zu <https://www.gdms.cloud>

Die GNU GPL Lizenz ist in der Gerätesoftware hinterlegt und kann über die Web-Schnittstelle unter my\_device\_ip/gpl\_license (Endgerät\_ip/gpl\_Lizenz) aufgerufen werden. Die Lizenz ist ebenfalls abrufbar unter <https://www.grandstream.com/legal/open-source-software>. Um eine CD mit der Lizenz zu erhalten, senden Sie uns bitte eine Email an [info@Grandstream.com](mailto:info@Grandstream.com).

Das ausführliche Benutzerhandbuch kann geladen werden von: <https://www.grandstream.com/our-products>

## PANORAMICA

GWN7670 è un punto di accesso Wi-Fi 7 di livello enterprise di nuova generazione progettato per gli ambienti SMB. Offre la tecnologia 2x2:2 MIMO sulla banda 2.4GHz e 2x2:2 MIMO sulla banda 5GHz, insieme a un sofisticato design di antenne. La modulazione 4096-QAM di Wi-Fi 7 garantisce incrementi significativi della velocità di trasferimento dati, mentre le tecnologia MLO ottimizza l'uso delle risorse di spettro per offrire a tutti gli utenti un'esperienza fluida. Per garantire facilità di installazione e gestione, GWN7670 eredita il design di gestione di rete distribuito senza centralina dalla serie GWN766x, con la centralina integrata nell'interfaccia utente Web del prodotto. Il GWN7670 è inoltre supportato da GDMS Networking e GWN Manager, la piattaforma di gestione Wi-Fi cloud e on-premise di Grandstream. È l'AP Wi-Fi ideale per le implementazioni voice-over-Wi-Fi e offre una connessione perfetta con i telefoni IP Wi-Fi di Grandstream. Con supporto per la QoS avanzata, applicazioni in tempo reale a bassa latenza, reti mesh, captive portal, servizi di localizzazione Bluetooth con BLE 5.3, 256 client concorrenti e 2 porte di rete a 2,5 Gigabit (una per il supporto di PoE+), GWN7670 è un access point Wi-Fi ideale per le implementazioni di reti wireless di medie dimensioni con una densità di utenti medio-alta.

## PRECAUZIONI

- Non tentare di aprire, smontare o modificare il dispositivo.
- Non esporre il dispositivo a temperature esterne alla gamma da 0 °C a 45 °C per il funzionamento e alla gamma da -30 °C a 60 °C per la conservazione.
- Non esporre GWN7670 ad ambienti fuori dal seguente intervallo di umidità: 10-90% UR (senza condensa).
- Non spegnere/accendere il GWN7670 durante l'avvio del sistema o l'aggiornamento del firmware. Ciò potrebbe comportare il danneggiamento del firmware e il malfunzionamento dell'unità.

## CONTENUTO DELLA CONFEZIONE

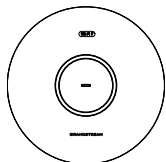

Punto di accesso GWN7670

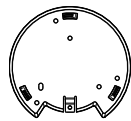

Staffe di montaggio

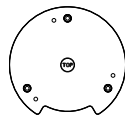

Staffa per montaggio a soffitto



## PORTE GWN7670

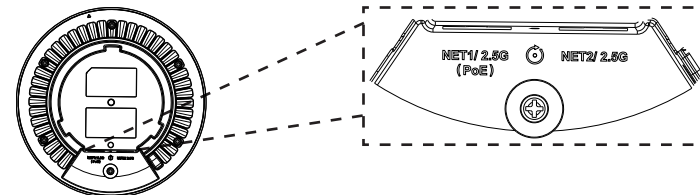

Porta	Descrizione
NET1/2.5G (PoE)	Porta Ethernet RJ45 (2.5Gbps), che supporta PoE/PoE+.
NET2/2.5G	Porta Ethernet RJ45 (2.5Gbps).
RESET	Pulsante ripristino di fabbrica. Premere per 7 secondi per ripristinare le impostazioni predefinite di fabbrica.

## ACCENSIONE E COLLEGAMENTO DEL GWN7670

GWN7670 possono essere alimentati usando l'interruttore PoE/PoE+ mediante i passi seguenti:

**Passo 1:** Collegare il cavo Ethernet RJ45 alla porta di rete (NET1) del GWN7670.

**Passo 2:** Collegare l'altra estremità nella porta uplink dell'interruttore power over Ethernet (PoE/PoE+).

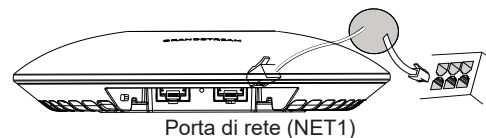

Porta di rete (NET1)

Cavo Ethernet RJ45 a interruttore Alimentazione su Ethernet (PoE/PoE+)

## INSTALLAZIONE HARDWARE

GWN7670 può essere montato a parete o soffitto. Fare riferimento ai passi seguenti per la corretta installazione.

## Supporto montaggio a parete

1. Posizionare la staffa di montaggio nella posizione desiderata sulla parete con la freccia rivolta verso l'alto.
2. Usare una matita per contrassegnare i quattro fori di montaggio (fori vite DIA 5,5 mm, foro reticolo DIA 25 mm).
3. Se il cavo Ethernet passa attraverso il muro, tagliare o praticare un cerchio di circa 18 mm di diametro.
4. Inserire gli ancoraggi delle viti nel foro da 5,5 mm. Fissare la staffa di montaggio alla parete inserendo le viti negli ancoraggi.

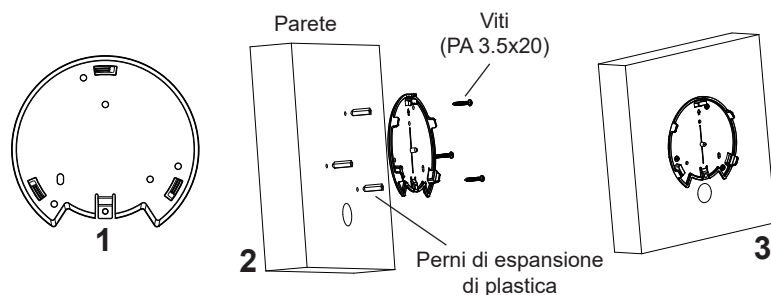

5. Collegare il cavo di alimentazione Ethernet (RJ45) alle porte corrette del proprio GWN7670.
6. Allineare la freccia sul GWN7670 AP con la freccia sulla linguetta di bloccaggio della staffa di montaggio e assicurare che il proprio GWN7670 sia posto in modo saldo sulle staffe di montaggio.
7. Ruotare il GWN7670 in senso orario fino a quando si blocca in posizione e si adatta alla linguetta di bloccaggio.

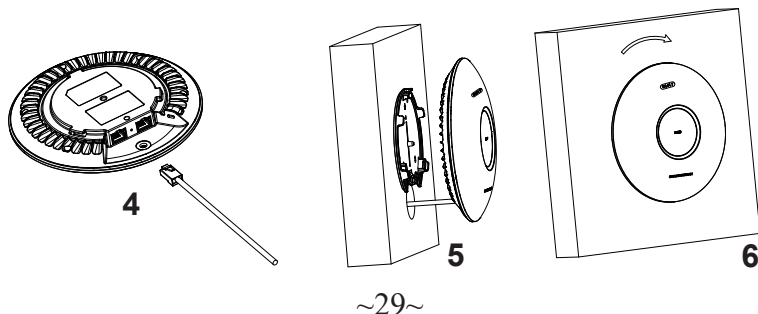

## Montaggio a soffitto

*Nota: Montaggio a soffitto è raccomandato per prestazioni di copertura ottimali.*

1. Rimuovere la piastrella del soffitto.
2. Porre la piastra posteriore per il soffitto al centro della piastrella del soffitto e contrassegnare i fori delle viti di montaggio (fori vite DIA 5,5 mm, foro reticolo DIA 25 mm).
3. Inserire le viti attraverso la piastra di montaggio.

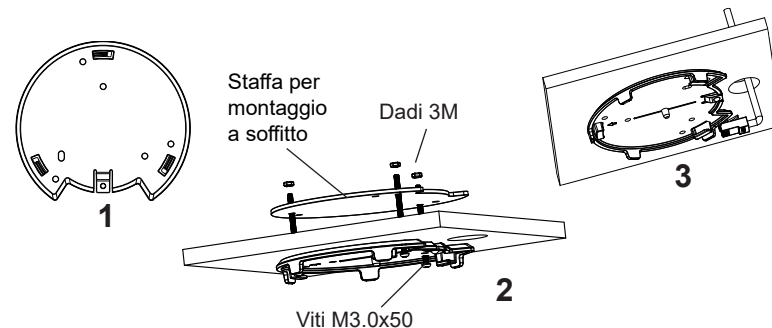

4. Collegare il cavo di alimentazione Ethernet (RJ45) alle porte corrette del proprio GWN7670.
5. Allineare la freccia sul GWN7670 AP con la freccia sulla linguetta di bloccaggio della staffa di montaggio e assicurare che il proprio GWN7670 sia posto in modo saldo sulle staffe di montaggio e collegare i cavi di rete e di alimentazione.
6. Ruotare il GWN7670 in senso orario fino a quando si blocca in posizione e si adatta alla linguetta di bloccaggio.

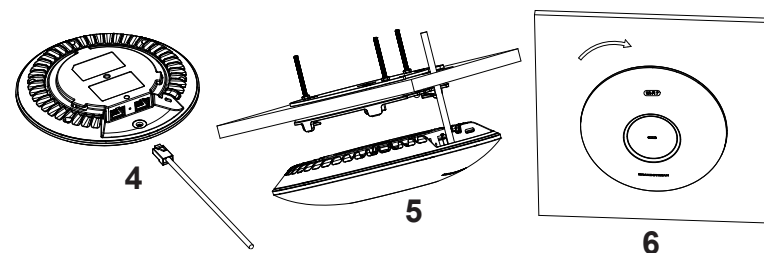

## COLLEGAMENTO DEL GWN7670 ALLA RETE Wi-Fi PRE DEFINITA

GWN7670 può essere usato come punto di accesso indipendente o dopo il ripristino alle impostazioni di fabbrica con Wi-Fi abilitato come predefinito.

Dopo l'accensione del GWN7670 e il collegamento alla rete, GWN7670 trasmetterà un SSID predefinito basato sul suo indirizzo MAC **GWN[ultime 6 cifre del MAC]** e una password casuale.

**Nota:** Le informazioni password e SSID predefinito di GWN7670 sono stampate sull'etichetta MAC dell'unità.



## ACCESSO ALL'INTERFACCIA DI CONFIGURAZIONE

Un computer collegato all'SSID del GWN7670 o alla stessa rete del GWN7670 può scoprire e accedere all'interfaccia di configurazione usando uno dei seguenti metodi:

### Metodo 1: Scoprire GWN7670 usando il suo indirizzo MAC

1. Individuare il mac address sull'etichetta posizionata nella parte bassa dell'apparato o sulla confezione.
2. Da un computer collegato alla stessa rete del GWN7670, digitare il seguente indirizzo usando l'indirizzo MAC del GWN7670 sul proprio browser **https://gwn\_<mac>.local**

**Esempio:** se un GWN7670 ha come indirizzo MAC EC:74:D7:8C:4D:F8, è possibile accedere a questa unità digitando **https://gwn\_ec74d78c4df8.local** sul browser.

### Metodo 2: Scoprire GWN7670 usando GWNDiscoveryTool

1. Scaricare e installare **GWNDiscoveryTool** dal link seguente: <https://www.grandstream.com/tools/GWNDiscoveryTool.zip>

2. Aprire il **GWNDiscoveryTool** e fare clic su **Scan**.
3. Il tool scoprirà tutti i Punti di accesso GWN7670 collegati alla rete mostrando i loro indirizzi MAC e IP.
4. Fare clic su on **Gestisci dispositivo** per essere reindirizzati direttamente all'interfaccia di configurazione GWN7670 o digitare manualmente l'indirizzo IP visualizzato sul proprio browser.
5. Immettere nome utente e password per accedere. (Lo username di default dell'amministratore è "admin" e la password casuale di default può essere trovata sull'etichetta del GWN7670).

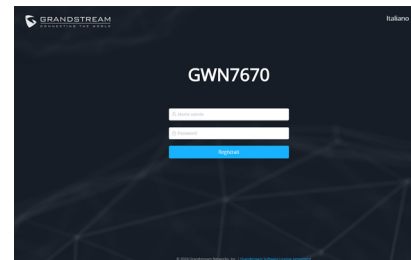

### Note:

- Assicurarsi che GWN7670 non sia già accoppiato con un altro Punto di accesso GWN76xx come slave, router GWN, dispositivo GCC o GDMS Networking Cloud, altrimenti non sarà possibile accedere all'interfaccia di configurazione.
- Se il GWN7670 è già accoppiato, assicurarsi di scollegarlo prima ed effettuare un ripristino alle impostazioni di fabbrica.
- E' responsabilità del cliente assicurarsi della conformità alle regolamentazioni locali in termini di bande di frequenza, potenza di trasmissione e altro.
- Per la gestione del GWN7670 sul cloud, fare riferimento a <https://www.gdms.cloud>

I termini della licenza GNU GPL sono incorporati nel firmware del dispositivo e sono accessibili tramite l'interfaccia utente Web del dispositivo a: [ip\\_dispositivo/gpl\\_license](https://www.grandstream.com/legal/open-source-software). È anche possibile accedervi all'indirizzo: <https://www.grandstream.com/legal/open-source-software>. Per ottenere un CD con informazioni sul codice sorgente GPL, si prega di inviare una richiesta scritta a [info@grandstream.com](mailto:info@grandstream.com)

Scaricare il manuale utente dettagliato da: <https://www.grandstream.com/our-products>



## VISÃO GERAL

O GWN7670 é um ponto de acesso Wi-Fi 7 de nível empresarial de última geração projetado para ambientes SMB. Ele oferece tecnologia 2x2:2 MIMO na banda de 2,4 GHz e 2x2:2 MIMO na banda de 5 GHz, juntamente com um design de antena sofisticado. A modulação 4096-QAM do Wi-Fi 7 proporciona aumentos significativos nas taxas de transferência de dados, enquanto a tecnologia MLO otimiza a utilização dos recursos do espectro para garantir uma experiência tranquila para cada usuário. Para facilitar a instalação e o gerenciamento, o GWN7670 herda o design de gerenciamento de rede distribuída sem controlador da série GWN766x, com o controlador incorporado na interface de usuário da Web do produto. O GWN7670 também é compatível com os sistemas de gerenciamento na nuvem GDMS Networking e local GWN Manager da Grandstream. É o ponto de acesso Wi-Fi ideal para implantações de voz sobre Wi-Fi e oferece uma conexão perfeita com telefones IP com capacidade Wi-Fi da Grandstream. Com suporte para QoS avançado, aplicativos em tempo real de baixa latência, redes mesh, portais cativos, serviços de localização Bluetooth com BLE 5.3, 256 clientes simultâneos por AP e 2 portas de rede de 2,5 Gigabit (uma com suporte a PoE+), o GWN7670 é um ponto de acesso Wi-Fi ideal para implantações de rede sem fio com densidade de usuários média a alta.

## PRECAUÇÕES

- Não tente abrir, desmontar, ou modificar o dispositivo.
- Não expor o dispositivo a temperaturas fora do intervalo dos 0 °C até os 45 °C em operação e o intervalo dos -30 °C até os 60 °C em armazenamento.
- Não exponha este dispositivo em ambientes com umidade fora do intervalo: 10-90% HR (sem condensação).
- Não desligue e ligue a energia do GWN7670 durante o reinício do sistema ou durante a atualização de firmware. Você pode corromper o firmware e causar a avaria do dispositivo.

## CONTEÚDO DO PACOTE



Access Point GWN7670

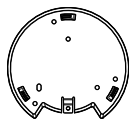

Suporte de Montagem

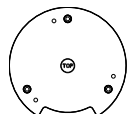

Suporte de montagem no teto

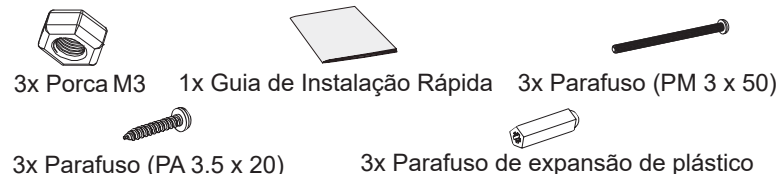

## PORTAS DO GWN7670

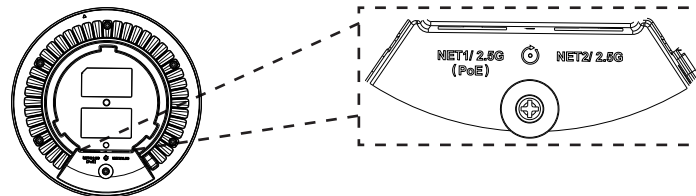

Porta	Descrição
NET1/2.5G (PoE)	Portas Ethernet RJ45 (2.5Gbps), com suporte PoE+.
NET2/2.5G	Ethernet RJ45 port (2.5Gbps).
RESET	Tecla de reset de fábrica. Pressionar durante 7 segundos para restabelecer as configurações aos padrões de fábrica.

## INICIANDO E CONECTANDO O GWN7670

O GWN7670 pode ser alimentado utilizando um switch PoE/PoE+ seguindo as seguintes instruções:

**Passo 1:** Collegare il cavo Ethernet RJ45 alla porta di rete (NET1) del GWN7670.

**Passo 2:** Conecte a outra ponta na porta do switch PoE/PoE+ (Power over Ethernet).

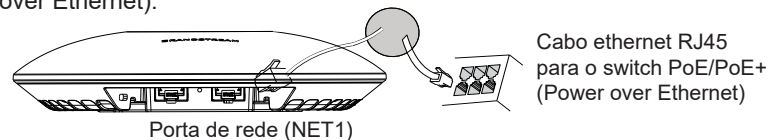

## INSTALAÇÃO DO HARDWARE

O GWN7670 pode ser montado na parede ou no teto. Por favor consulte os seguintes passos para uma correta instalação.

## Montagem na Parede

1. Posicionar o suporte de montagem na localização desejada na parede com a seta apontando para acima.
2. Utilize um lápis para marcar o lugar dos quatro furos da montagem (furo do parafuso DIA 5.5mm, furo da retícula DIA 25mm).
3. Se o cabo ethernet passa pela parede, deverá fazer um círculo com aproximadamente 18 mm de diâmetro.
4. Insira as buchas dos parafusos nos furos de 5.5 mm. Segure o suporte de montagem à parede inserindo os parafusos nas buchas.

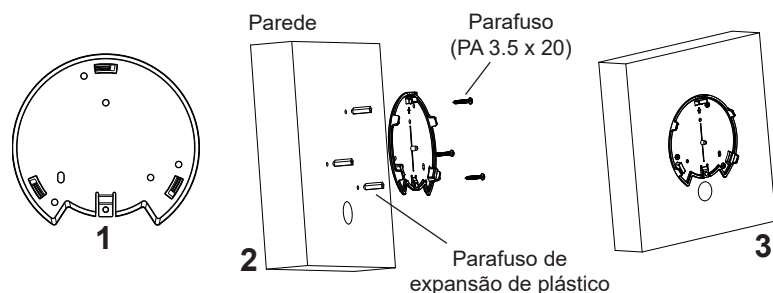

5. Conecte o cabo ethernet (RJ45) à porta correspondente no seu GWN7670.
5. Utilize um lápis para marcar o lugar dos quatro furos da montagem (furo do parafuso DIA 5.5mm, furo da retícula DIA 25mm).
6. Insira as buchas dos parafusos nos furos de 5.5 mm. Segure o suporte de montagem à parede inserindo os parafusos nas buchas.

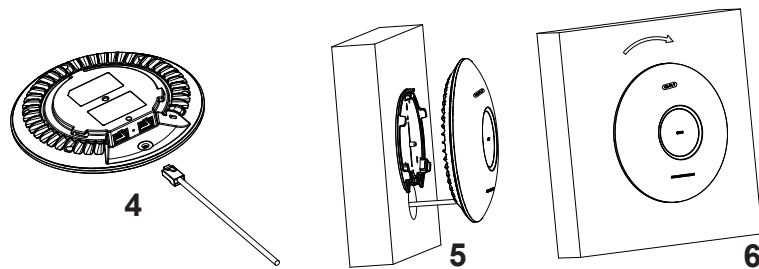

## Montagem no Teto

**Nota:** A montagem no teto é recomendada para um ótimo desempenho de cobertura.

1. Remover a placa do teto.
2. Colocar a o suporte de teto no centro da placa do teto e marque o lugar dos furos para os parafusos da montagem (furo do parafuso DIA 5.5mm, furo da retícula DIA 25mm).
3. Inserir os parafusos através do suporte de montagem.

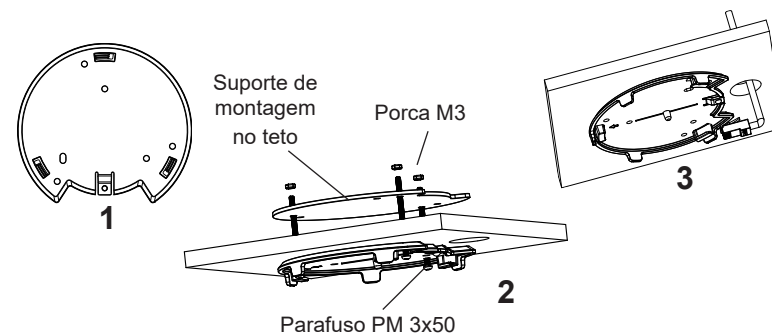

4. Conecte o cabo ethernet (RJ45) à porta correspondente no seu GWN7670.
5. Alinhar a seta do GWN7670 AP com a seta que esta no guia de travamento do suporte de montagem e verificar que seu GWN7670 está firmemente fixado no suporte de montagem e conecte os cabos de alimentação e de rede.
6. Vire o GWN7670 em sentido horário até encaixar no lugar e se encaixa no guia de travamento.

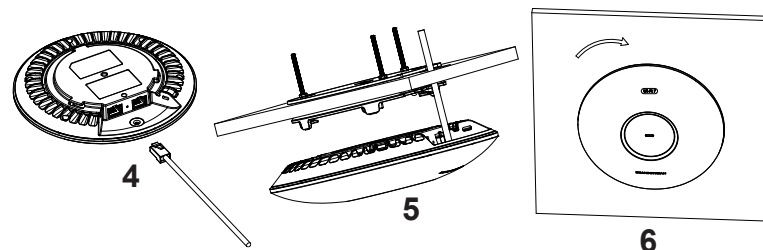



## CONECTAR À REDE Wi-Fi PADRÃO DO GWN7670

O GWN7670 pode ser utilizado como um access point independente ao momento de abrir a caixa, ou após um reset de fábrica com o Wi-Fi habilitado por padrão.

Depois de abrir a caixa do GWN7670 e conecta-lo à rede, o GWN7670 irá transmitir o SSID padrão baseado no endereço MAC **GWN[últimos 6 dígitos da MAC]** e uma senha aleatória.

**Aviso:** A informação do SSID e senha padrão do GWN7670 estão impressos na etiqueta da MAC do dispositivo.

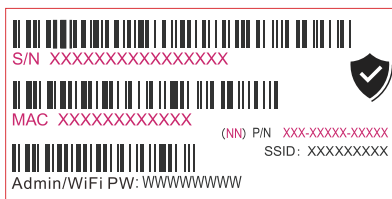

## ACESSAR À INTERFACE DE CONFIGURAÇÃO

Um computador conectado ao SSID do GWN7670, ou em a mesma rede que o GWN7670 pode descobrir e acessar à interface de configuração utilizando um dos métodos mencionados abaixo:

### Método 1: Descobrir o GWN7670 utilizando o endereço MAC

1. Localize o endereço MAC na etiqueta que está na parte de baixo do dispositivo, ou na embalagem.
2. A partir do computador conectado na mesma rede que o GWN7670, coloque no seu navegador o endereço **https://gwn\_<mac>.local** utilizando o endereço MAC do GWN7670.

**Exemplo:** se um GWN7670 possui o endereço MAC EC:74:D7:8C:4D:F8, esta unidade pode ser acessada colocando o endereço **https://gwn\_ec74d78c4df8.local** no seu navegador.

### Método 2: Descobrir o GWN7670 utilizando o GWNDiscoveryTool

1. Baixar o **GWNDiscoveryTool** a partir do link: <https://www.grandstream.com/tools/GWNDiscoveryTool.zip>

2. Abrir o **GWNDiscoveryTool**, e clique em **Scan**.
3. A ferramenta irá descobrir todos os Access Points GWN7670 conectados à rede, exibindo os endereços MAC e IP.
4. Clique em **Manage Device** para ser direcionado diretamente à interface de configuração do GWN7670, ou coloque manualmente no navegador o endereço IP exibido.
5. Coloque o nome de usuário e a senha para fazer o login. (O nome de usuário padrão para o administrador é "admin" e a senha aleatória pre-determinada pode ser encontrada na etiqueta do GWN7670).

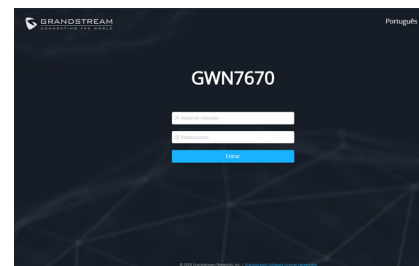

### Nota:

- *Certifique-se de que o GWN7670 não esteja pareado com outro ponto de acesso GWN76xx como escravo, roteador GWN, dispositivo GCC ou com a plataforma na nuvem GDMS Networking, caso contrário, a interface de configuração não poderá ser acessada.*
- *Se o GWN7670 já estiver emparelhado, certifique-se de que o desemparelha primeiro e, em seguida, efectue uma reposição de fábrica.*
- *É responsabilidade do cliente assegurar o cumprimento das regulamentações locais para as bandas de frequência, para a potência de transmissão e outras.*
- *Para gerenciar o GWN7670 a partir da plataforma na nuvem, por favor consulte o link <https://www.gdms.cloud>*

Os termos de licença GNU GPL estão dentro do firmware do dispositivo e você pode visualizar o documento através da interface web do dispositivo, em `my_device_ip/gpl_license`. Também, pode visualizar o documento através do site: <https://www.grandstream.com/legal/open-source-software>  
Para obter um CD com a informação do código fonte GPL, por favor solicite-o através de `info@grandstream.com`

Para o manual do usuário detalhado, faça o download desde: <https://www.grandstream.com/our-products>

## ОБЗОР ПРОДУКТА

GWN7670 - это Wi-Fi 7 точка доступа следующего поколения корпоративного класса, разработанная для малого и среднего бизнеса. Она поддерживает технологию 2x2:2 MIMO в диапазоне 2,4 ГГц и 2x2:2 MIMO в диапазоне 5 ГГц, а также сложную конструкцию антенны. Модуляция 4096-QAM в Wi-Fi 7 обеспечивает значительное увеличение скорости передачи данных, а технология MLO оптимизирует использование ресурсов спектра, чтобы обеспечить бесперебойную работу для каждого пользователя. Чтобы упростить установку и управление, GWN7670 унаследовал дизайн распределенного управления сетью без контроллера из серии GWN766x, со встроенным в пользовательский веб-интерфейс контроллером. Также GWN7670 поддерживается GDMS Networking и GWN Manager, облачной и локальной платформами управления Wi-Fi сетями от компании Grandstream. Эта точка доступа идеальна для развёртывания сетей для использования voice-over-Wi-Fi и обеспечивает простое соединение с телефонами с поддержкой Wi-Fi от компании Grandstream. С поддержкой расширенного QoS, приложений реального времени с низкой задержкой, mesh сетей, captive порталов, служб определения местоположения Bluetooth с BLE 5.3, 256 одновременных клиентов на точку доступа и 2x 2,5 гигабитных сетевых порта (один поддерживает PoE+), GWN7670 идеальной Wi-Fi точкой доступа для беспроводных сетей среднего размера со средним/высоким количеством пользователей.

## МЕРЫ ПРЕДОСТОРОЖНОСТИ

- Не пытайтесь открыть, разобрать или изменить устройство.
- Не подвергайте воздействию температуры вне диапазона от 0 °C до 45 °C при эксплуатации и от -30°C до 60°C при хранении.
- Не используйте данное устройство в среде, где значение влажности выходит за диапазон: Относит. влажность 10%-90% (без конденсации)
- Не включать-выключать устройство GWN7670 в процессе начального запуска системы или в процессе обновления прошивки. Вы можете тем самым повредить заводскую прошивку устройства и вывести его из строя.

## СОДЕРЖИМОЕ УПАКОВКИ

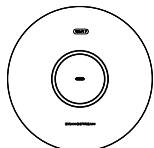

Точка доступа GWN7670



Монтажный  
Кронштейн

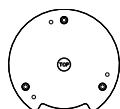

Потолочный  
монтажный кронштейн



3x Винта (PM 3 x 50)



3x Винта (PM 3,5 x 20)



3x Пластиковые  
дюбеля



3x M3 гайки

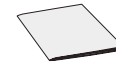

1x Руководство по быстрой установке

## ПОРТЫ GWN7670

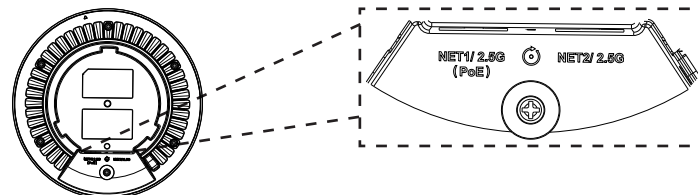

Порты	Описание
NET1/2.5G (PoE)	Порт Ethernet RJ45 (2.5Gбит/сек). с поддержкой PoE+.
NET2/2.5G	Порт Ethernet RJ45 (2.5Gбит/сек).
RESET	Кнопка сброса до заводских настроек Нажать и удерживать в течение 7 секунд для сброса до заводских настроек.

Условия лицензии GNU GPL включены в прошивку устройства и доступны через веб-интерфейс пользователя устройства по адресу [my\\_device\\_ip/gpl\\_license](https://www.grandstream.com/legal/gpl_license). Также можно получить доступ здесь: <https://www.grandstream.com/legal/open-source-software> Для получения компакт-диска с информацией об исходном коде GPL, пожалуйста, отправьте письменный запрос по адресу [info@grandstream.com](mailto:info@grandstream.com)

Подробное руководство пользователя можно загрузить здесь: <https://www.grandstream.com/our-products>

## **Certification Regulatory Information**

### **Common part:**

This equipment complies with radiation exposure limits set forth for an uncontrolled environment. This transmitter must not be co-located or operating in conjunction with any other antenna or transmitter. This equipment should be installed and operated with minimum distance 20cm between the radiator & your body.

Après examen de ce matériel aux conformité ou aux limites d'intensité de champ RF, les utilisateurs peuvent sur l'exposition aux radiofréquences et la conformité and compliance d'acquérir les informations correspondantes. La distance minimale du corps à utiliser le dispositif est de 20cm.

**This equipment is for indoor use only.**

### **U.S. FCC Part 15 Regulatory Information**

This device complies with part 15 of the FCC Rules. Operation is subject to the following two conditions: (1) this device may not cause harmful interference, and (2) this device must accept any interference received, including interference that may cause undesired operation.

Any Changes or modifications not expressly approved by the party responsible for compliance could void the user's authority to operate the equipment.

Note: This equipment has been tested and found to comply with the limits for a Class B digital device, pursuant to part 15 of the FCC Rules. These limits are designed to provide reasonable protection against harmful interference in a residential installation. This equipment generates uses and can radiate radio frequency energy and, if not installed and used in accordance with the instructions, may cause harmful interference to radio communications. However, there is no guarantee that interference will not occur in a particular installation. If this equipment does cause harmful interference to radio or television reception, which can be determined by turning the equipment off and on, the user is encouraged to try to correct the interference by one or more of the following measures:

- Reorient or relocate the receiving antenna.
- Increase the separation between the equipment and receiver.
- Connect the equipment into an outlet on a circuit different from that to which the receiver is connected.
- Consult the dealer or an experienced radio/TV technician for help.

### **Canada Regulatory Information**

#### **Radio equipment**

This device contains licence-exempt transmitter(s)/receiver(s) that comply with Innovation, Science and Economic Development Canada's licence-exempt RSS(s). Operation is subject to the following two conditions:

- (1) This device may not cause interference.
- (2) This device must accept any interference, including interference that may cause undesired operation of the device.

L'émetteur/récepteur exempt de licence contenu dans le présent appareil est conforme aux CNR d'Innovation, Sciences et Développement économique Canada applicables aux appareils radio exempts de licence. L'exploitation est autorisée aux deux conditions suivantes :

- 1) L'appareil ne doit pas produire de brouillage;
- 2) L'appareil doit accepter tout brouillage radioélectrique subi, même si le brouillage est susceptible d'en compromettre le fonctionnement.

### **CAN ICES-003 (B)/NMB-003(B)**

This product meets the applicable Innovation, Science and Economic Development Canada technical specifications.

Le présent produit est conforme aux spécifications techniques applicables d'Innovation, Sciences et Développement économique Canada.

### **EU Regulatory Information**

In all EU member states, operation of 5150-5350 MHz is restricted to indoor use only.

Support Frequency Bands and Power:

- BIE 2402-2480 MHz < 10 dBm;
- WLAN 2412-2472 MHz < 20 dBm;
- RLAN 5150-5250 MHz < 23 dBm;
- RLAN 5250-5350 MHz < 23 dBm;
- RLAN 5470-5725 MHz < 30 dBm.
- RLAN 5745-5825 MHz < 14 dBm.

The simplified EU declaration of conformity referred to in Article 10(9) shall be provided as follows:

Hereby, [Grandstream Networks, Inc.] declares that the radio equipment type [GWN7670] is in compliance with Directive 2014/53/EU.

The full text of the EU declaration of conformity is available at the following internet address: [www.grandstream.com](http://www.grandstream.com)