

Grandstream Networks, Inc.

126 Brookline Ave, 3rd Floor
Boston, MA 02215. USA
Tel : +1 (617) 566 - 9300

www.grandstream.com



BE	BG	CZ	DK	DE	EE	IE	EL	LI	
ES	FR	HR	IT	CY	LV	LT	LU	CH	
HU	MT	NL	AT	PL	PT	RO	SI	TR	
SK	FI	SE	NO	IS	UK	UK(NI)			

In the UK and EU member states, operation of 5150-5350 MHz is restricted to indoor use only.



For Certification, Warranty and RMA information, please visit
www.grandstream.com



WP826

Cordless Wi-Fi IP Phone

Quick Installation Guide

Content

English.....	1
简体中文.....	6
Español.....	11
Français.....	16
Deutsch.....	21
Italiano.....	26
Русский.....	31
Português.....	36
Regulatory information.....	41

The WP826 is not pre-configured to support or make emergency calls to any type of hospital, law enforcement agency, medical care unit ("Emergency Service(s)") or any other kind of Emergency Service. You must make additional arrangements to access Emergency Services. It is your responsibility to purchase SIP-compliant Internet telephone service, properly configure the WP826 to use that service, and periodically test your configuration to confirm that it works as you expect. It is also your responsibility to purchase traditional wireless or landline telephone services to access Emergency Services.

GRANDSTREAM DOES NOT PROVIDE CONNECTIONS TO EMERGENCY SERVICES VIA THE WP826. NEITHER GRANDSTREAM NOR ITS OFFICES, EMPLOYEES OR AFFILIATES MAY BE HELD LIABLE FOR ANY CLAIM, DAMAGE, OR LOSS, AND YOU HEREBY WAIVE ANY AND ALL SUCH CLAIMS OR CAUSES OF ACTION ARISING FROM OR RELATING TO YOUR INABILITY TO USE THE WP826 TO CONTACT EMERGENCY SERVICES, AND YOUR FAILURE TO MAKE ADDITIONAL ARRANGEMENTS TO ACCESS EMERGENCY SERVICES IN ACCORDANCE WITH THE IMMEDIATELY PRECEDING PARAGRAPH.

The GNU GPL license terms are incorporated into the device firmware and can be accessed via the Web user interface of the device at my_device_ip/gpl_license. It can also be accessed here: <http://www.grandstream.com/legal/open-source-software>
To obtain a CD with GPL source code information please submit a written request to info@grandstream.com

PRECAUTIONS

- Do not attempt to open, disassemble, or modify the device.
- Do not use a third party power adapter.
- Do not expose the device to temperatures outside the range 0 °C to 45 °C (in operation) and -20 °C to 60 °C (in storage).
- Do not expose the WP826 at environments outside of the humidity range of 10-90% RH (non-condensing).

OVERVIEW

The WP826 is a cordless Wi-Fi IP phone suitable for many enterprise and vertical market applications, including offices, retail, logistics, healthcare, security, and more. This high-end cordless Wi-Fi phone is equipped with integrated dual band Wi-Fi 6, an advanced antenna design, roaming support, 4-way voice conferencing, and support for the Opus HD voice codec. The WP826 provides 12 hours of talk-time and 240 hours of standby time through a 3000mAh battery to drive employee productivity. By providing a sleek design, easy-to-use interface, and a variety of practical, customizable features, the WP826 provides mobility and flexibility to all voice solutions.

WP826 PACKAGE CONTENTS



1x WP826 Handset



1x M3 Screw



1x Wall bracket



1x Handset Belt Clip



1x Rechargeable Battery



1x Charging Station



1x Type-C 5V power adapter

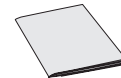

1x Quick Installation Guide

SETTING UP THE WP826

Charging Station:

Plug the power adapter into a power source socket to start using the charging station.

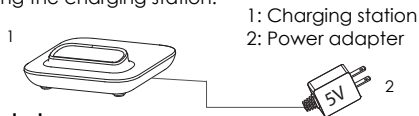

Handset:

- Open the battery cover from the opening port.
- Insert the battery with the electrodes in the bottom left corner.
- Close the battery cover.

Note: Please charge the battery fully before using the handset for the first time.

- 1: Battery cover
- 2: Battery
- 3: Rear of handset

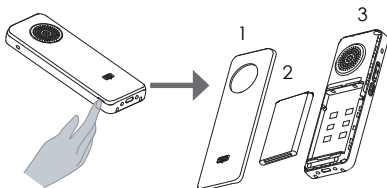

INSTALLING THE WP826 ON THE WALL

1. Unscrew the M3 screw of the charge station and take out the wall bracket
2. Drill holes on the wall and insert expansion screws
3. Thread the screw through the wall bracket and fix it to the wall
4. Place the charge station and wall bracket together
5. Fix the charge station and bracket with M3 screw
6. Insert into the phone

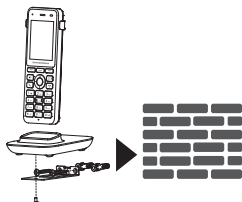

~3~

WP826 DESCRIPTION

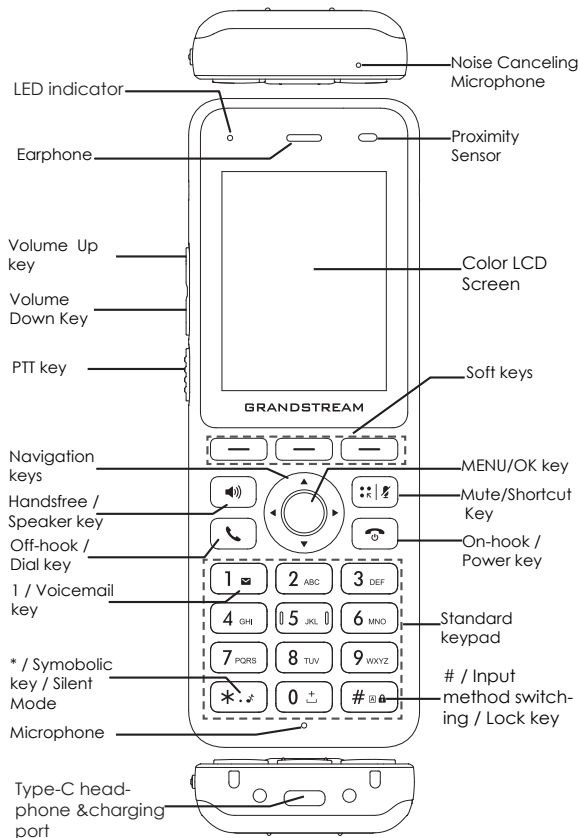

~4~

CONNECTING WP826 TO WI-FI NETWORK

1. On LCD menu, press Menu key and navigate to Settings → Wi-Fi Settings.

2. Set Wi-Fi to "On" and navigate to "Wi-Fi Network". A list of Wi-Fi networks will be displayed.

3. Select the desired network to connect to. (Enter the correct password to connect if requested)

WP826 will display Wi-Fi icon on top of the main LCD menu if the connection to the Wi-Fi network is successful.

ACCESSING WP826 WEB GUI

1. Press the UP button to see the IP address.

2. Type the phone's IP address in your PC browser.

Note: The computer needs to be on same network as WP826.

3. Enter admin's username and password to access the configuration menu. (The factory default username is "admin" while the default random password can be found on the sticker at the back of the unit).



Refer to online documents and FAQ for more detailed information: <https://www.grandstream.com/our-products>

WP826不预设对医院、执法机构、医疗中心(急救服务)以及各种紧急服务的紧急通话服务。用户必须自行设定紧急通话功能。用户必须自行购买SIP兼容的网络电话服务,正确地设定WP826使用该服务,并定期测试您的配置以确保WP826如预期工作,否则请购买传统无线或有线电话服务来拨打紧急通话。

Grandstream Networks 公司的WP826不支持紧急通话服务。Grandstream Networks公司、其管理者和员工以及其相关机构对此所造成的任何索赔、损失或者损害都不负有任何法律追究责任。在此,您将无权对任何以及所有由于无法通过WP826拨打紧急电话以及没有遵照前段文字描述而造成紧急通话失败的事件提出诉讼。

GNU GPL许可条款已包含在设备固件中,可以通过设备的Web用户界面 my_device_ip/gpl_license 进行访问。也可以通过以下链接访问: <http://www.grandstream.com/legal/open-source-software>

如果需要包含GPL源代码信息的CD,请发邮件到 info@grandstream.com 提交请求。

注意事项

- 请不要打开、拆卸或修改该设备。
- 请不要使用第三方的电源适配器。
- 请勿将设备暴露在 0°C 至 45°C (运行时) 和 -20°C 至 60°C (存储时) 范围之外的温度下。
- 不要将本设备暴露在环境湿度如下范围以外: 10-90%RH (无冷凝)。

产品概览

WP826 是一款便携式 Wi-Fi 手机, 旨在满足各种企业和垂直市场的应用需求, 包括零售, 物流, 医疗和安全。这款功能强大的便携式电话配备了双频 802.11a/b/g/n/ac/ax Wi-Fi, 先进的天线设计并支持漫游。通过增加高清语音的双麦克风, WP826 提供了功能性, 移动性和耐用性的强大组合, 可满足所有便携式电话的需求。

WP826 设备包装清单

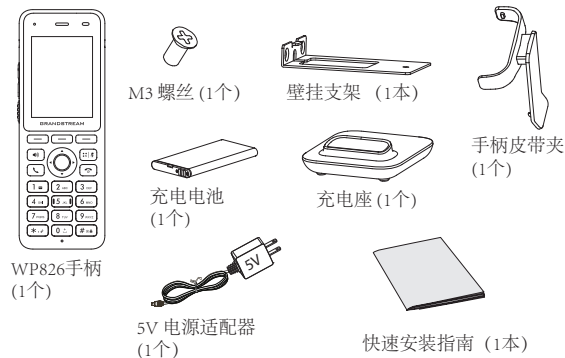

配置 WP826

充电站:

将电源适配器插入电源插座以开始使用充电站。

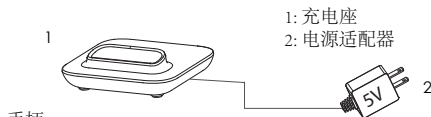

手柄:

- 打开电池盖。
- 将电池的电极端插入左下角。
- 合上电池盖。

注意: 在首次使用手柄之前请将电池充满电。

- 1: 电池盖
2: 电池
3: 手柄后部

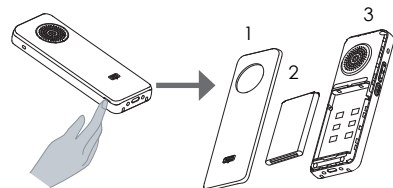

挂墙安装 WP826

1. 拧下充电底座上的 M3 螺丝, 并取出墙壁支架
2. 在墙上钻孔并插入膨胀螺钉
3. 将螺钉穿过墙壁支架并固定在墙上
4. 将充电底座和墙壁支架放在一起
5. 用 M3 螺钉固定充电底座和支架
6. 将话机放置在充电底座上

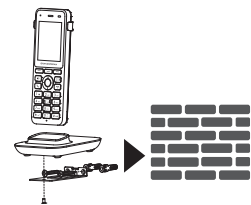

WP826 简介

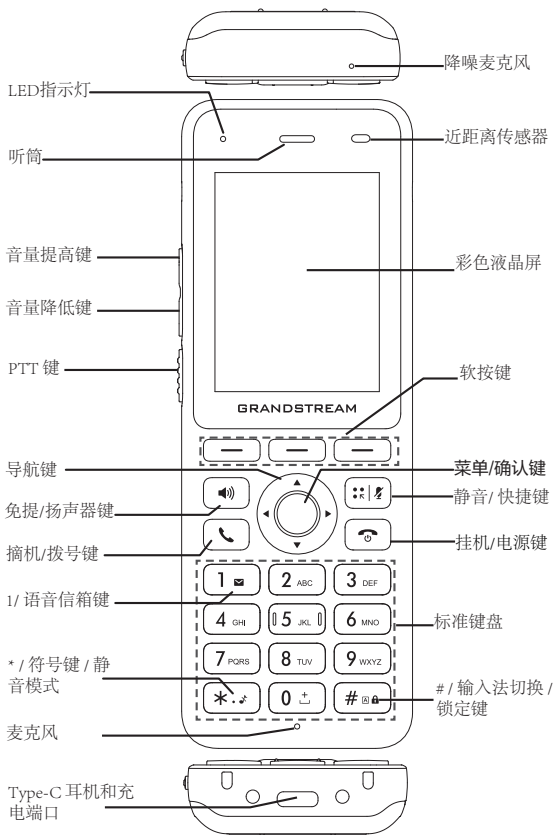

~9~

连接WP826至Wi-Fi网络

1. 在LCD菜单中, 按菜单键和导航键至: 设置 → 网络设置。
2. 按下“上”方向键, 此时电话屏幕显示话机IP地址;
3. 选择想要连接的网络。(如果要求, 请输入正确的密码进行连接) 如果与Wi-Fi网络的连接成功, WP826将在LCD主页顶部显示Wi-Fi状态图标。

打开WP826网页用户界面

1. 按下“上”方向键, 此时电话屏幕显示话机IP地址;
2. 在您电脑浏览器中输入话机IP地址。
注意: 电脑和WP826应在同一网络中。
3. 输入管理员账号及密码, 进入配置页面。(出厂默认用户名为“admin”, 出厂默认随机密码可以在设备背后的贴纸上找到)。



欲获取详细的话机使用信息, 请在以下链接中下载WP826用户手册。
<http://www.grandstream.com/our-products>

~10~

WP826 no está pre-configurado para soportar o realizar llamadas de emergencia a ningún tipo de hospital, agencia policial, unidad de cuidado médico o cualquier otro servicio de emergencia. Es su responsabilidad contratar un servicio de telefonía de Internet compatible con el protocolo SIP, configurar el WP826 para utilizar dicho servicio y periódicamente probar esta configuración para confirmar que este trabajando como usted espera. Si es requisito no es completado, es su responsabilidad contratar un servicio de telefonía fija o celular para tener acceso a servicios de emergencia.

GRANDSTREAM NO PROVEE CONEXIONES A SERVICIOS DE EMERGENCIA A TRAVÉS DEL WP826. NI GRANDSTREAM NI NINGUNO DE SUS OFICIALES, EMPLEADOS O AFILIADOS SON RESPONSABLES DE NINGUNA DEMANDA, DAÑO O PERDIDA QUE ESTO PUEDA OCASIONAR Y MEDIANTE ESTE COMUNICADO USTED RENUNCIA A CUALQUIER RECLAMO O CONSECUENCIA PROVENIENTE O RELACIONADO DE LA INHABILIDAD DE CONTACTAR SERVICIOS DE EMERGENCIAS CON EL WP826 Y SU FALTA DE NO HABER HECHO LOS ARREGLOS DE LUGAR PARA ACCESAR ESTOS SERVICIOS DE EMERGENCIA DE ACUERDO CON EL PÁRRAFO ANTERIOR.

Los términos de licencia GNU GPL son incorporados en el firmware del dispositivo y puede ser accedido a través de la interfaz de usuario Web del dispositivo en ip_de_mi_dispositivo/gpl_license. También puede ser accedido aquí: <http://www.grandstream.com/legal/open-source-software> Para obtener un CD con la información del código fuente GPL, por favor, remita una solicitud escrita a info@grandstream.com

PRECAUCIONES:

- No intente abrir, desmontar o modificar el equipo.
- No utilizar un adaptador de alimentación de terceros.
- No exponga el dispositivo a temperaturas fuera del rango de 0 °C a 45 °C (en funcionamiento) y de -20 °C a 60 °C (en almacenamiento).
- No exponga este dispositivo en entornos fuera del siguiente rango de humedad: 10-90%RH (sin condensación).

RESUMEN

El WP826 es un teléfono Wi-Fi portátil diseñado para cumplir con una gran variedad de empresas y aplicaciones del mercado. Incluyendo almacenes, bodegas, hospitales y seguridad. Este poderoso teléfono Wi-Fi viene equipado con Wi-Fi de dos-bandas 802.11a/b/g/n/ac/ax. Diseño avanzado de antena y soporte de roaming.

Al incluir voz HD con dos micrófonos, el WP826 ofrece una poderosa combinación de características, movilidad y durabilidad para satisfacer todas las necesidades de la telefonía portable.

PAQUETE CONTENIDO DEL WP826



1x WP826
Auricular



1x Tornillo M3



1x Soporte de
pared



1x Cinturón
Clip
para Au-
ricular



1x Batería
Recargable



1x Estación
de carga



1x Adaptador
de Energía 5v

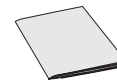

1x Guía de Instalación
Rápido

CONFIGURACIÓN DEL WP826

Estación de carga:

Conecte el adaptador de corriente a una toma de corriente para comenzar a usar la estación de carga.

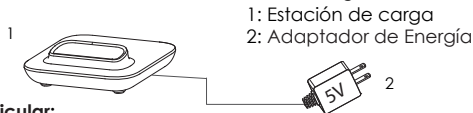

Auricular:

- Abra la tapa de la batería..
- Inserte la batería con los electrodos en la esquina superior derecha.
- Cierre la tapa de la batería.

Nota: Cargue la batería por completo antes de usar el teléfono por primera vez.

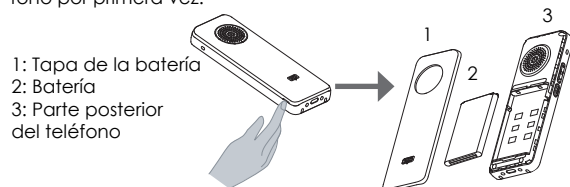

INSTALACIÓN DEL WP826 EN LA PARED

1. Remueva el tornillo M3 de la estación de carga y retire el soporte de pared.
2. Taladre agujeros en la pared e inserte los tornillos de expansión.
3. Pase el tornillo a través del soporte de pared y fíjelo a la pared.
4. Coloque la estación de carga y el soporte de pared juntos
5. Fije la estación de carga y el soporte con un tornillo M3
6. Inserte el teléfono en la estación de carga.

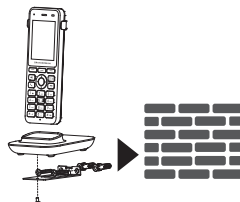

DESCRIPCIÓN WP826

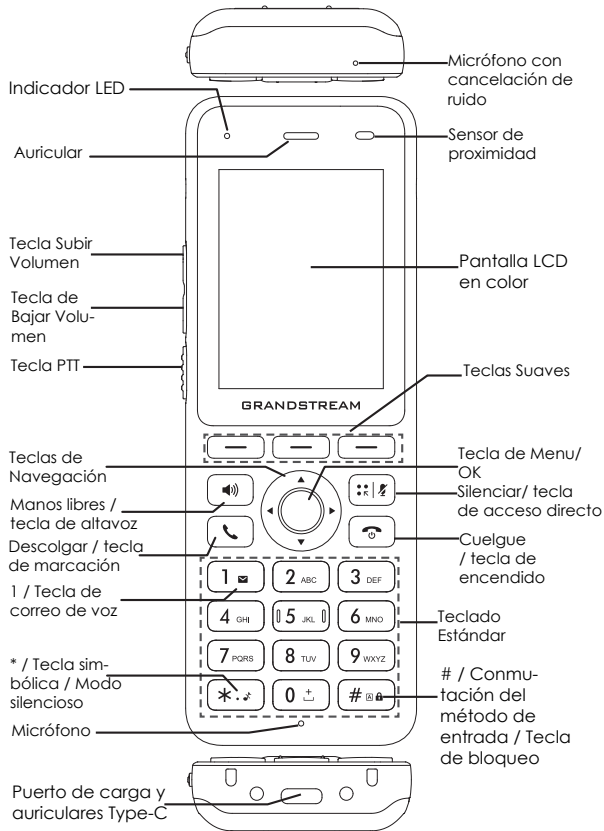

CONECTANDO WP826 A RED WI-FI

1. En el menú LCD, presione la tecla Menú y vaya a Configuración → Configuración Wi-Fi.
2. Configure Wi-Fi como "Encendido" y navegue las "Red Wi Fi". Se mostrará una lista de redes Wi-Fi.
3. Seleccione la red deseada para conectarse. (Ingrese la contraseña correcta para conectarse si se solicita)

WP826 mostrará el icono de Wi-Fi en el menú principal de la pantalla LCD si la conexión a la red Wi-Fi es exitosa.

ACCEDER A LA WEB GUI DE WP826

1. Presione el botón de ARRIBA para ver la dirección IP.
2. Escriba la dirección IP en su navegador web.

Nota: La computadora necesita estar en la misma red que WP826.

3. Ingrese como administrador para ver el menú de configuración. (El usuario es "admin" y la contraseña aleatoria debería estar en la etiqueta en la parte trasera de la unidad).



Consulte la documentación en línea y preguntas frecuentes para información más detallada.
<http://www.grandstream.com/our-products>

FR

Le WP826 n'est pas préconfiguré pour prendre en charge ou acheminer les appels d'urgence adressés aux hôpitaux, organismes chargés de l'application de la loi, centres de soins médicaux (« service(s) d'urgence ») ou tout autre type de service d'urgence. Vous devez prendre des dispositions supplémentaires pour assurer l'accès aux services d'urgence. Il est de votre responsabilité de vous abonner à un service de téléphonie Internet conforme au protocole SIP, de configurer correctement le WP826 pour utiliser ce service, et de tester périodiquement votre configuration pour vous assurer qu'elle fonctionne comme prévu. Si vous ne le faites pas, vous devez vous abonner à un service de téléphonie sans fil ou fixe traditionnel pour accéder aux services d'urgence.

GRANDSTREAM NE FOURNIT PAS DE CONNEXIONS AUX SERVICES D'URGENCE VIA LE WP826. NI GRANDSTREAM, NI SES DIRIGEANTS, EMPLOYES OU SOCIÉTÉS AFFILIÉES NE PEUVENT ÊTRE TENUS RESPONSABLES POUR TOUTE RECLAMATION, TOUT DOMMAGE OU PERTE, ET VOUS RENONCEZ PAR LES PRÉSENTES À TOUTE RECLAMATION OU TOUT MOTIF D'ACTION EN JUSTICE DÉCOULANT OU LIÉ À VOTRE INCAPACITÉ D'UTILISER LE WP826 POUR CONTACTER LES SERVICES D'URGENCE, ET TOUTE NEGLIGENCE DE VOTRE PART QUANT À PRENDRE DES DISPOSITIONS SUPPLÉMENTAIRES POUR ACCÉDER AUX SERVICES D'URGENCE CONFORMÉMENT À L'ALINÉA PRÉCÉDENT.

Les termes de la licence GNU GPL sont incorporés dans le micrologiciel du périphérique et sont accessibles via l'interface utilisateur Web du périphérique à l'adresse `my_device_ip / gp_license`. Vous pouvez également y accéder ici: <http://www.grandstream.com/legal/open-source-software>

Pour obtenir un CD contenant les informations du code source GPL, veuillez envoyer une demande écrite à info@grandstream.com.

PRÉCAUTIONS

- Ne tentez pas d'ouvrir, de démonter ou de modifier l'appareil.
- N'utilisez pas un adaptateur de courant tiers.
- N'exposez pas l'appareil à des températures en dehors de 0 °C à 45 °C (en fonctionnement) et de -20 °C à 60 °C (en stockage).
- Ne pas exposer cet appareil à un environnement avec humidité hors de la plage de 10-90% RH (sans condensation).

OVERVIEW

Le WP826 est un téléphone Wi-Fi portable conçu pour répondre aux besoins de nombreuses entreprises et applications du marché vertical, notamment la vente au détail, la logistique, le médical et la sécurité. Ce téléphone Wi-Fi portable et puissant est équipé d'un support Wi-Fi double bande intégré 802.11a/b/g/n/ac/ax, d'une conception d'antenne avancée et d'une prise en charge de l'itinérance. En ajoutant la voix HD aux doubles MIC, le WP826 offre une puissante combinaison de fonctionnalités, de mobilité et de durabilité pour répondre à tous les besoins en matière de téléphonie portable.

CONTENU DE L'EMBALLAGE WP826

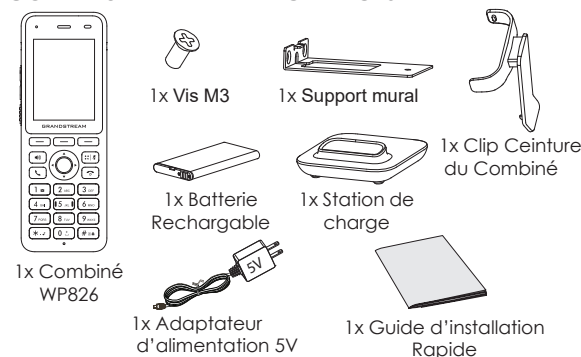

INSTALLATION DU WP826

Station de charge:

Branchez l'adaptateur d'alimentation dans une prise d'alimentation pour commencer à utiliser la station de charge.

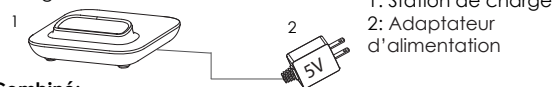

Combiné:

- Ouvrez le couvercle de la batterie.
- Insérez la batterie avec les électrodes dirigés vers le coin en haut à droite.
- Fermez le couvercle de la batterie.

Remarque: Veuillez charger complètement la batterie avant d'utiliser le combiné pour la première fois.

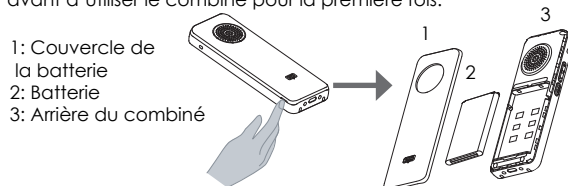

INSTALLATION DU WP826 AU MUR

1. Dévissez la vis M3 de la borne de recharge et retirez le support mural
2. Percez deux trous dans le mur et insérez les vis d'expansion
3. Enfilez la vis dans le support mural et fixez-la au mur.
4. Placez la station de charge et le support mural ensemble
5. Fixez la station de charge et le support avec une vis M3
6. Insérer le téléphone sur la station du charge

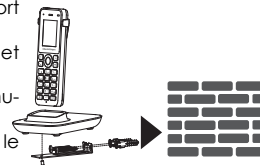

DESCRIPTION DU WP826

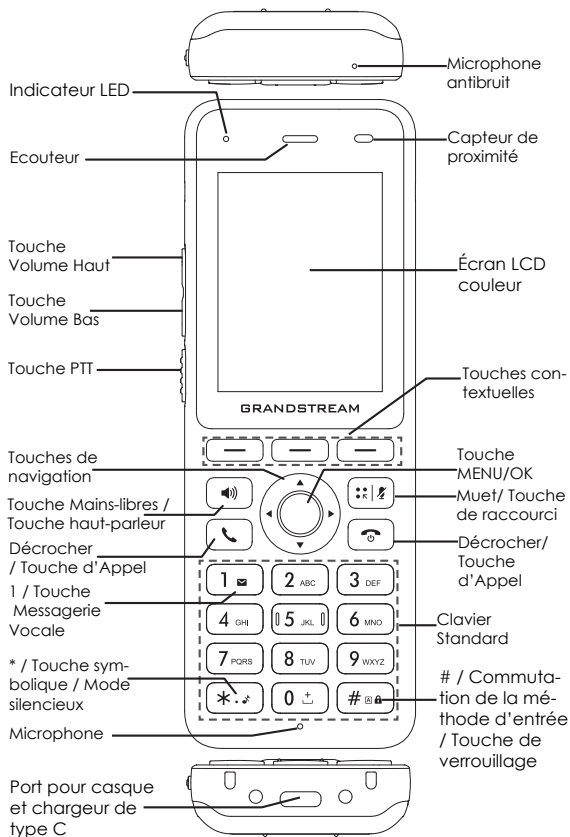

~19~

CONNEXION DU WP826 AU RÉSEAU WI-FI

1. Dans le menu LCD, appuyez sur la touche Menu et accédez à Paramètres → Paramètres Wi-Fi.

2. Réglez le Wi-Fi sur "On" et naviguez jusqu'à "Réseaux Wi-Fi". Une liste des réseaux Wi-Fi disponibles sera affichée.

3. Sélectionnez le réseau auquel vous souhaitez vous connecter. (Entrez le mot de passe correct pour vous connecter si nécessaire).

Le WP826 affichera une icône Wi-Fi sur le menu principal de l'écran LCD si la connexion au réseau Wi-Fi est réussie.

ACCEDER A L'INTERFACE DU WP826

1. Appuyez sur le bouton HAUT pour afficher l'adresse IP.

2. Saisissez l'adresse IP du téléphone dans votre navigateur PC .

Remarque: L'ordinateur doit être sur le même réseau que le WP826.

3. Entrez le nom d'utilisateur et le mot de passe de l'administrateur pour accéder au menu de configuration. (Le nom d'utilisateur par défaut est «admin», tandis que le mot de passe aléatoire par défaut se trouve sur l'autocollant situé à l'arrière de l'appareil).

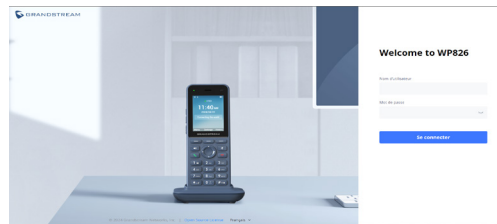

Veillez se référer aux documents en ligne et FAQ pour plus d'informations: <http://www.grandstream.com/our-products>

~20~

Im WP826 sind keine Notfallrufnummern voreingestellt oder vorkonfiguriert. Das WP826 tätigt keine automatischen Anrufe zu medizinischen, sozialen oder juristischen Hilfs- oder Serviceorganisationen. Die Anbindung an derartige Einrichtungen muss separat eingestellt bzw. zur Verfügung gestellt werden. Es liegt in der Verantwortung des Nutzers, einen SIP-konformen Internet-Telefon-Service zu buchen, der die Nutzung der örtlichen und überregionalen Notrufnummern sicherstellt. Bietet der SIP-Anbieter diesen Service nicht, liegt es in der Verantwortung des Nutzers, einen analogen bzw. alternativen Telefonanschluss zusätzlich bereit zu stellen, um eine telefonische Anbindung für Notfälle sicherstellen zu können.

GRANDSTREAM STELLT MIT DEM WP826 KEINE VERBINDUNG ZU NOTFALLRUFNUMMER ODER DIE ANBINDUNG AN NOTFALLZENTREN ZUR VERFÜGUNG. WEDER GRANDSTREAM, NOCH GRANDSTREAM MITARBEITER, ANGESTELLTE ODER SONSTIGE FIRMEANGEHÖRIGE SIND FÜR DIE ANDBINDUNG DES WP826 AN EINEN MEDIZINISCHEN SERVICE ODER ANDEREN NOTFALLDIENST ZUSTÄNDIG, BZW. VERANTWORTLICH. ES OBLIGT ALLEINIG IN DER VERANTWORTUNG DER WP826 NUTZER BZW. DER WP826 BESITZER, FÜR EINE NETZANBINDUNG ZU SORGEN, WELCHE DIE NUTZUNG VON MEDIZINISCHEN ODER ANDEREN NOTFALLRUFNUMMERN SICHERSTELLT.

Die GNU GPL Lizenz ist in der Gerätesoftware hinterlegt und kann über die Web-Schnittstelle unter `my_device_ip/gpl_license` (Endgerät_ip/gpl_Lizenz aufgerufen werden. Die Lizenz ist ebenfalls abrufbar unter <http://www.grandstream.com/legal/open-source-software>. Um eine CD mit der Lizenz zu erhalten, senden Sie uns bitte eine Email an info@Grandstream.com.

VORSICHTSMASSNAHMEN

- Das Produkt darf nicht geöffnet, modifiziert oder anderweitig verändert bzw. verwendet werden.
- Benutzen Sie nur das beiliegende Netzteil, kein Netzteil von Drittanbietern.
- Setzen Sie das Gerät keinen Temperaturen außerhalb des Bereichs von 0 °C bis 45 °C (im Betrieb) und -20 °C bis 60 °C (bei Lagerung) aus.
- Das Produkt darf nur innerhalb eines Bereiches mit einer relativen Luftfeuchte von 10-90% (nicht kondensierend) genutzt werden.

ÜBERBLICK

Das WP826 ist ein tragbares WLAN-Telefon, der mobile Begleiter für die täglichen Kommunikationsanforderungen in den Bereichen Logistik, Einzelhandel, Medizin, Pflege, oder einfach in der ganz normalen Büroumgebung. Das leistungsstarke WLAN Telefon kann in 2,4GHz & 5GHz (802.11a/b/g/n/ac/ax) Netzen betrieben werden und unterstützt Roaming zwischen den AccessPoints. Natürlich bietet das WP826 Sprachkommunikation (inkl. Freisprechen) in HD Qualität und ist somit ein zuverlässiges und einfach zu bedienendes Kommunikations-Tool für viele Anwendungsbereiche.

WP826 LIEFERUMFANG



1x WP826 Hör-Sprechereinheit



1x M3-Schraube



1x Wandhalterung



1x Handset Gürtelclip



1x Wiederauflade Batterie



1x Ladestation



1x 5V Netzteil

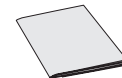

1 x Kurz- Installationsanleitung

INBETRIEBNAHME DES WP826

Ladestation:

Stecken Sie das Netzteil in eine Steckdose, um die Ladestation in Betrieb zu nehmen.

- 1: Ladestation
2: Netzteil

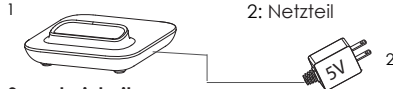

Hör-Sprecheinheit:

- Öffnen Sie die Batterieabdeckung.
- Legen Sie den Akku ein und achten Sie darauf, dass sich die Akkukontakte in der oberen rechten Ecke befinden.
- Schließen Sie die Batterieabdeckung.

Hinweis: Bitte laden Sie die Batterie (Akku) vor der ersten Nutzung vollständig auf.

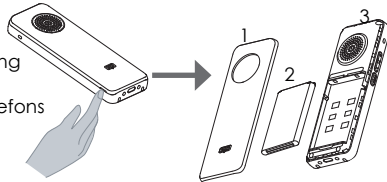

- 1: Batterieabdeckung
2: Batterie (Akku)
3: Rückseite des Telefons

INSTALLATION DES WP826 AN DER WAND

1. Schrauben Sie die M3-Schraube der Ladestation heraus und nehmen Sie die Wandhalterung heraus.
2. Bohren Sie Löcher in die Wand und setzen Sie Dübel ein.
3. Führen Sie die Schraube durch die Wandhalterung und befestigen Sie sie an der Wand.
4. Platzieren Sie die Ladestation und die Wandhalterung zusammen.
5. Befestigen Sie die Ladestation und die Halterung mit der M3-Schraube.
6. Setzen Sie das Telefon in die Ladestation ein.

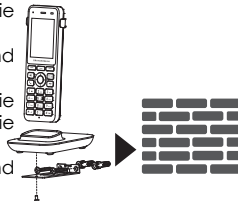

WP826 BESCHREIBUNG

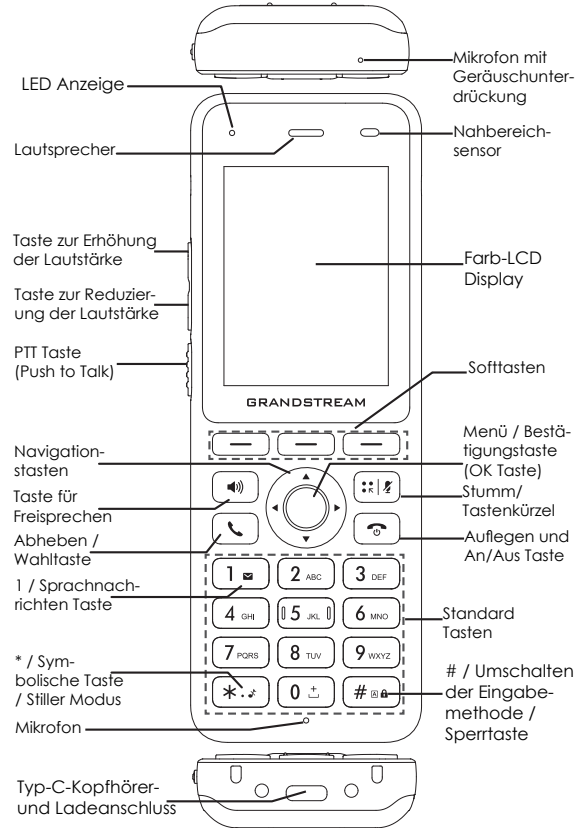

VERBINDEN DES WP826 MIT DEM WLAN (WI-FI NETZWERK)

1. Drücken Sie im LCD-Menü die Menütaste und navigieren Sie zu Einstellungen → Wi-Fi-Einstellungen.
2. Stellen Sie Wi-Fi auf „Ein“ und navigieren Sie zu „Wi-Fi-Netzwerk“. Eine Liste der Wi-Fi-Netzwerke wird angezeigt.
3. Wählen Sie das gewünschte Netzwerk aus und geben Sie das richtige Passwort auf Anfrage ein.

Bei erfolgreicher Anmeldung wird im Display des WP826 das WLAN (Wi-Fi) Symbol angezeigt.

ZUGANG ZUR WP826 WEBSCHNITTSTELLE

1. Drücken Sie die UP Taste um die IP Adresse zu sehen.
2. Geben Sie die IP Adresse des Telefons in die Adresszeile Ihres Webbrowsers ein.

Hinweis: Der Computer/Laptop muss im selben Netzwerk wie das WP826 angemeldet sein.

3. Geben Sie die die Anmeldeinformationen ein und wechseln Sie in das Konfigurationsmenü. (Herstellerseitig ist der Benutzername „admin“, das Zufallspasswort finden Sie auf der Rückseite der Basisstation.



Weitere Informationen und Dokumentationen sind online unter:
<http://www.grandstream.com/our-products>

WP826 non è preconfigurato per supportare o effettuare chiamate di emergenza a qualsiasi tipo di ospedale, struttura giudiziaria, unità di assistenza medica ("Servizi di emergenza") o a qualsiasi altro tipo di servizio di emergenza. È necessario effettuare accordi supplementari per accedere ai Servizi di emergenza. E' a Vostra esclusiva responsabilità acquistare servizi di telefonia internet conformi con SIP, configurare WP826 correttamente per usare tale servizio ed effettuare test periodici della configurazione per assicurarsi che funzioni in modo idoneo. Se non si effettua ciò, è Vostra responsabilità acquistare servizi telefonici fissi o wireless tradizionali per accedere ai Servizi di emergenza.

GRANDSTREAM NON FORNISCE COLLEGAMENTI AI SERVIZI DI EMERGENZA ATTRAVERSO WP826. NÈ GRANDSTREAM NÈ I SUOI RESPONSABILI, DIPENDENTI O AFFILIATI POSSONO ESSERE RITENUTI RESPONSABILI DI QUALSIASI RECLAMO, DANNO O PERDITA, E DI QUALSIASI AZIONE LEGALE DERIVANTE DA TALI RECLAMI O CAUSE IN RELAZIONE ALL'IMPOSSIBILITÀ DI USARE IL WP826 PER CHIAMATE AI SERVIZI O DI STRINGERE ACCORDI SUPPLEMENTARI PER ACCEDERE AI SERVIZI DI EMERGENZA IN CONFORMITÀ AL PARAGRAFO PRECEDENTE.

I termini della licenza GNU GPL sono incorporati nel firmware del dispositivo e sono accessibili tramite l'interfaccia utente Web del dispositivo a: ip_dispositivo/gpl_license. È anche possibile accedervi all'indirizzo: <http://www.grandstream.com/legal/open-source-software>

Per ottenere un CD con informazioni sul codice sorgente GPL, si prega di inviare una richiesta scritta a info@grandstream.com

PRECAUZIONI

- Non tentare di aprire, smontare o modificare il dispositivo.
- Non utilizzare un alimentatore di terzi.
- Non esporre il dispositivo a temperature al di fuori dell'intervallo compreso tra 0 °C e 45 °C (durante il funzionamento) e tra -20 °C e 60 °C (durante lo stoccaggio).
- Non esporre il dispositivo ad ambienti fuori dal seguente intervallo di umidità: 10-90% UR (senza condensa).

PANORAMICA

Il telefono WP826 è un cordless Wi-Fi progettato per soddisfare una larga varietà di aziende e di applicazioni di mercato verticale, tra cui vendita al dettaglio, logistica, settore medico e sicurezza. Questo potente telefono Wi-Fi portatile è dotato di supporto Wi-Fi dual-band integrato 802.11a/b/g/n/ac/ax, con un design avanzato dell'antenna e supporto per il roaming. Integrando un doppio MIC per garantire qualità della voce in HD, il WP826 offre una potente combinazione di funzionalità, mobilità e durata per soddisfare tutte le esigenze di telefonia portatile.

CONTENUTO DELLA CONFEZIONE WP826



1x WP826 Ricevitore



1x Vite M3



1x Supporto a parete



1x Clip per cintura per ricevitore



1x Batteria ricaricabile



1x Stazione di carica



1x Alimentatore 5V

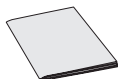

1x Guida rapida di installazione

INBETRIEBNAHME DES WP826

Stazione di carica:

Collegare l'adattatore a una presa di corrente per iniziare a usare la stazione di carica.

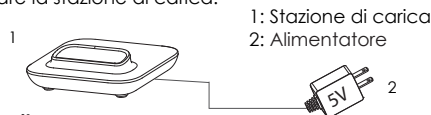

Ricevitore

- Aprire il coperchio della batteria.
- Inserire la batteria con gli elettrodi nell'angolo in alto a destra.
- Chiudere il coperchio della batteria.

Nota: Caricare la batteria completamente prima di usare il ricevitore per la prima volta.

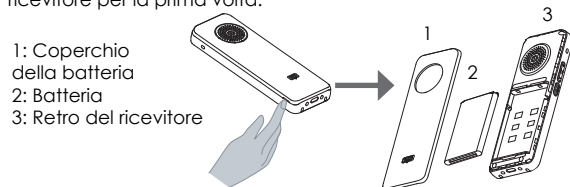

INSTALLAZIONE DEL WP826 A PARETE

1. Svitare la vite M3 della stazione di ricarica ed estrarre la staffa a parete
2. Praticare dei fori nel muro e inserire i tasselli.
3. Infilare la vite attraverso la staffa e fissarla alla parete
4. Agganciare la base di ricarica alla staffa a parete
5. Bloccare la base di ricarica e la staffa con la vite M3
6. Inserire il telefono nella base di ricarica

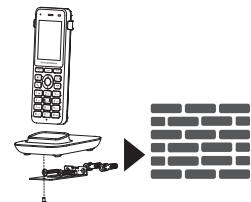

DESCRIZIONE WP826

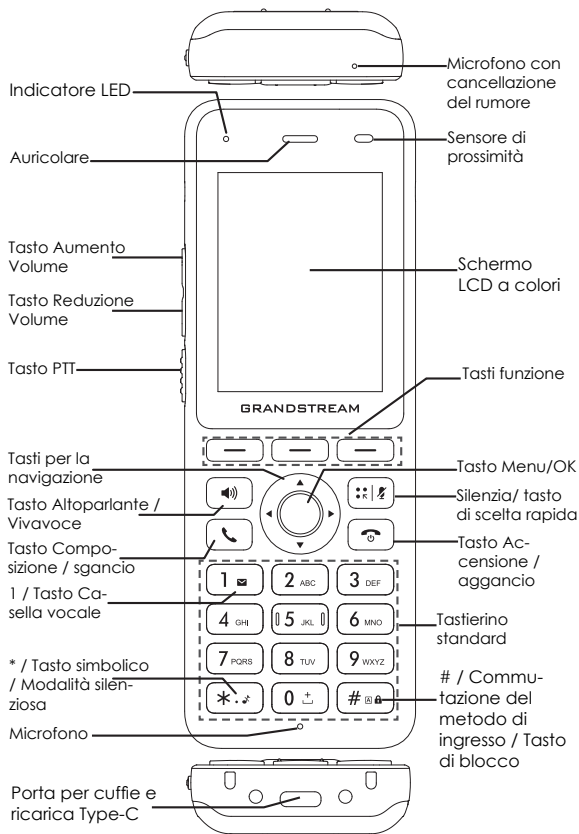

~29~

CONNETTERE IL WP826 ALLA RETE WI-FI

1. Nel menu LCD, premere il tasto Menu e accedere a Impostazioni → Impostazioni Wi-Fi.
 2. Impostare Wi-Fi su "On" e accedere a "Rete Wi-Fi". Verrà visualizzato un elenco di reti Wi-Fi.
 3. Selezionare la rete cui ci si desidera connettere. (Inserire la password corretta per connettersi, se richiesto)
- Il WP826 mostrerà l'icona Wi-Fi sulla schermata iniziale LCD se la connessione alla rete Wi-Fi dovesse riuscire.

ACCESSO ALLA GUI WEB DEL WP826

1. Premere il tasto UP per vedere l'indirizzo IP.
 2. Digitare l'indirizzo IP del telefono nel browser del vostro PC.
- Nota:** il computer deve essere sulla stessa rete del WP826.
3. Immettere il nome utente e la password dell'amministratore per accedere al menu di configurazione. (Il nome utente predefinito di fabbrica è "admin" mentre la password casuale predefinita può essere trovata sull'adesivo sul retro dell'unità).



Fare riferimento ai documenti online e alle Domande Frequenti per informazioni più dettagliate:
<http://www.grandstream.com/our-products>

~30~

WP826 не настроен заранее для поддержки и осуществления экстренных вызовов в больницу, правоохранительные органы, учреждения медицинской помощи ("Экстренная служба(-ы)") или другие Экстренные Службы. Чтобы получить доступ к Экстренным Службам необходимо заключить дополнительные соглашения. Вы несете ответственность за приобретение услуг телефонной связи через Интернет, поддерживающих протокол SIP, правильную настройку WP826 для использования этой связи и периодическую проверку надлежащей работы вашей конфигурации. Если вы не выполните этих условий, то вы самостоятельно несете ответственность за приобретение услуг обычной беспроводной или проводной телефонной связи для доступа к Экстренным Службам.

КОМПАНИЯ GRANDSTREAM НЕ ОБЕСПЕЧИВАЕТ СВЯЗЬ С АВАРИЙНЫМИ СЛУЖБАМИ ПРИ ПОМОЩИ УСТРОЙСТВА WP826. НИ КОМПАНИЯ GRANDSTREAM, НИ ЕЕ ДОЛЖНОСТНЫЕ ЛИЦА, СОТРУДНИКИ ИЛИ ДОЧЕРНИЕ ПРЕДПРИЯТИЯ НЕ НЕСУТ ОТВЕТСТВЕННОСТЬ ЗА КАКИЕ-ЛИБО СТРАХОВЫЕ СЛУЧАИ, УЩЕРБ ИЛИ УБЫТКИ. ТАКИМ ОБРАЗОМ, ВЫ ОТКАЗЫВАЕТЕСЬ ОТ ВСЕХ ПОДОБНЫХ ПРЕТЕНЗИЙ ИЛИ ОСНОВАНИЙ ДЛЯ ИСКА, ВЫТЕКАЮЩИХ ИЗ НЕВОЗМОЖНОСТИ ИСПОЛЬЗОВАНИЯ WP826 ДЛЯ СВЯЗИ С ЭКСТРЕННЫМИ СЛУЖБАМИ, А ТАКЖЕ ВАШЕГО НЕЖЕЛАНИЯ ЗАКЛЮЧИТЬ ДОПОЛНИТЕЛЬНЫЕ СОГЛАШЕНИЯ ДЛЯ ПОЛУЧЕНИЯ ДОСТУПА К ЭКСТРЕННЫМ СЛУЖБАМ СОГЛАСНО ПРЕДЫДУЩЕМУ ПАРАГРАФУ.

Условия лицензии GNU GPL включены в прошивку устройства и доступны через веб-интерфейс пользователя устройства по адресу `my_device_ip/gpl_license`. Также можно получить доступ здесь: <http://www.grandstream.com/legal/open-source-software>.

Для получения компакт-диска с информацией об исходном коде GPL, пожалуйста, отправьте письменный запрос по адресу info@grandstream.com.

МЕРЫ ПРЕДОСТОРОЖНОСТИ

- Не пытайтесь вскрывать, разбирать или изменять устройство.
- Не используйте адаптер питания сторонних производителей.
- Не подвергайте устройство воздействию температур, выходящих за пределы диапазона от 0 °C до 45 °C (при эксплуатации) и от -20 °C до 60 °C (при хранении).
- Не используйте данное устройство в среде, где значение влажности выходит за диапазон: 10%-90% (без конденсации)

ОБЩЕЕ ОПИСАНИЕ

WP826 - это портативный Wi-Fi телефон, разработанный для различных предприятий и решений для вертикальных рынков, включая розничную торговлю, логистику, медицину и безопасность. Этот мощный портативный Wi-Fi телефон оснащен встроенной поддержкой двух диапазонного Wi-Fi 802.11a/b/g/n/ac/ax, усовершенствованной антенной и поддержкой роуминга. Благодаря поддержке HD-звука с двумя микрофонами, WP826 дает мощную комбинацию функций, мобильность и долгое время работы, для удовлетворения всех потребностей портативной телефонии.

КОМПЛЕКТ ПОСТАВКИ WP826



1x WP826 трубка



1x винт M3



1x настенный кронштейн



1x Зажим для крепления к поясному ремню



1x аккумулятор



1x Зарядная станция



1x 5В Адаптер питания

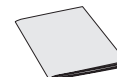

1x Краткое руководство

УСТАНОВКА WP826

Зарядная станция:

Вставьте адаптер питания в розетку для начала использования зарядной станции.

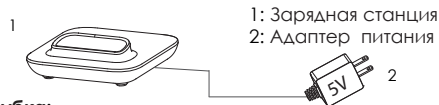

Трубка:

- Откройте аккумуляторный отсек.
- Вставьте аккумулятор, контакты должны быть в правом верхнем углу.
- Закройте аккумуляторный отсек.

Примечание: Перед первым использованием, пожалуйста, полностью зарядите аккумулятор трубки.

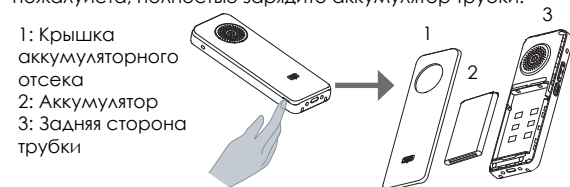

УСТАНОВКА WP826 НА СТЕНЕ

1. Открутите винт M3 зарядной станции и выньте настенный кронштейн.
2. Просверлите отверстия в стене и вставьте дюбель
3. Проденьте винт через настенный кронштейн и закрепите его на стене
4. Соедините зарядную станцию и настенный кронштейн вместе
5. Закрепите зарядную станцию и кронштейн винтом M3
6. Вставьте телефон в зарядную станцию

ОПИСАНИЕ WP826

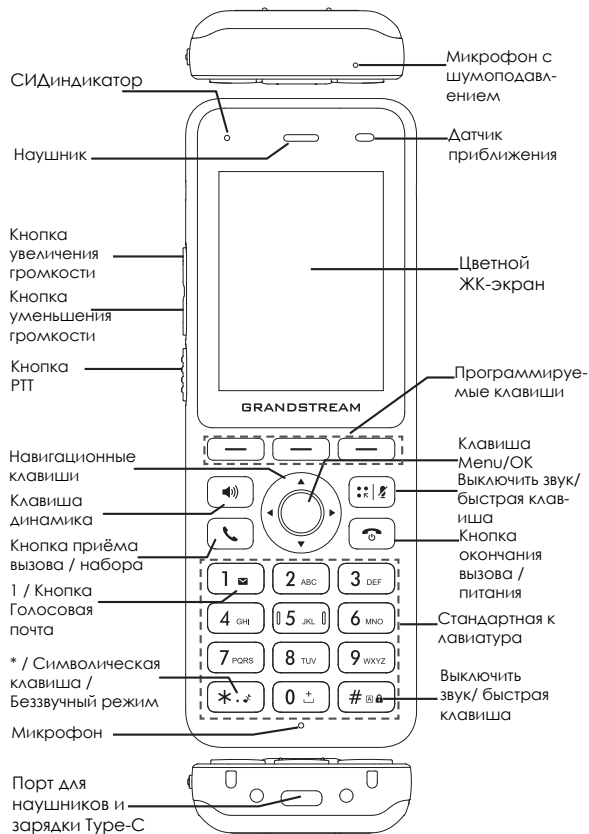

ПОДКЛЮЧЕНИЕ WP826 К WI-FI СЕТИ

1. В меню ЖК-дисплея нажмите кнопку Меню и перейдите к Настройке → Настройки Wi-Fi.

2. Установите для Wi-Fi значение "Вкл." и перейдите к пункту "Сеть Wi-Fi". Отобразится список сетей Wi-Fi.

3. Выберите сеть к которой Вы хотите подключиться. (Если необходимо, введите пароль для подключения)

При успешном подключении к сети, WP826 будет отображать иконку Wi-Fi на главном экране.

ДОСТУП В ВЕБ ГИП WP826

1. Нажмите кнопку UP, чтобы увидеть IP-адрес.

2. Введите IP-адрес Вашего телефона в браузере Вашего ПК.

Примечание: Компьютер должен быть подключен к той же сети, что и WP826.

3. Введите имя пользователя и пароль администратора для входа в меню конфигурации. (Имя пользователя по умолчанию - "admin", случайный пароль по умолчанию Вы можете найти на наклейке на задней стороне устройства.)



Смотрите электронные документы и раздел FAQ для более подробной информации:

<http://www.grandstream.com/our-products>

PT

O WP826 não é pré-configurado para suportar ou realizar chamadas de emergência a qualquer tipo de hospital, agência policial, unidade de atendimento médico ("Serviço (s) de emergência"), ou qualquer outro tipo de serviço de emergência. Você deverá tomar providências adicionais para acessar serviços de emergência. É da sua responsabilidade adquirir serviço de telefonia via Internet compatível com o protocolo SIP, configurar corretamente o WP826 para usar esse serviço e periodicamente testar a configuração para confirmar que ele funciona como você espera. Se você não fizer isso, é da sua responsabilidade adquirir os serviços tradicionais de telefones celulares ou fixos para acessar serviços de emergência.

GRANDSTREAM NÃO FORNECE CONEXÕES A SERVIÇOS DE EMERGÊNCIA ATRAVÉS DO WP826. NEM GRANDSTREAM, NEM OS SEUS DIRIGENTES, EMPREGADOS OU AFILIADOS PODEM SER RESPONSÁVEIS POR QUALQUER RECLAMAÇÃO, DANO OU PERDA, E VOCÊ, NESTE ATO, RENUNCIA QUAISQUER E TODAS REIVINDICAÇÕES OU MOTIVOS DE ACÇÃO RESULTANTES DA OU RELATIVA À SUA INCAPACIDADE DE USAR O WP826 PARA CONTATAR SERVIÇOS DE EMERGÊNCIA E POR NÃO FAZER ARRANJOS ADICIONAIS PARA ACEDER AOS SERVIÇOS DE EMERGÊNCIA, SEGUNDO O PARÁGRAFO IMEDIATAMENTE ANTERIOR.

Os termos de licença GNU GPL estão dentro do firmware do dispositivo e você pode visualizar o documento através da interface web do dispositivo, em my_device_ip/gpl_license. Também, pode visualizar o documento através do site: <http://www.grandstream.com/legal/open-source-software>

Para obter um CD com a informação do código fonte GPL, por favor solicite-o através de info@grandstream.com

PRECAUÇÕES:

- Não tente abrir, desmontar, ou modificar o dispositivo.
- Não utilize uma fonte de alimentação de outro fabricante.
- Não exponha o dispositivo a temperaturas fora da faixa de 0 °C a 45 °C (em operação) e -20 °C a 60 °C (em armazenamento).
- Não exponha este dispositivo em ambientes com umidade fora do intervalo: 10-90% HR (sem condensação).

SÍNTESE

O WP826 é um telefone Wi-Fi portátil projetado para atender uma variedade de empresas e aplicações verticais de mercado, incluindo varejo, logística, medicina e segurança. Este potente e portátil telefone Wi-Fi está equipado com suporte a 802.11 a/b/g/n/ac/ax de banda dupla integrado, desenho avançado de antenas e suporte a roaming. Ao adicionar voz HD com microfone duplo, o WP826 oferece uma poderosa combinação de recursos, mobilidade e durabilidade para atender a todas as necessidades de telefonia portátil.

WP826 CONTEÚDO DO PACOTE

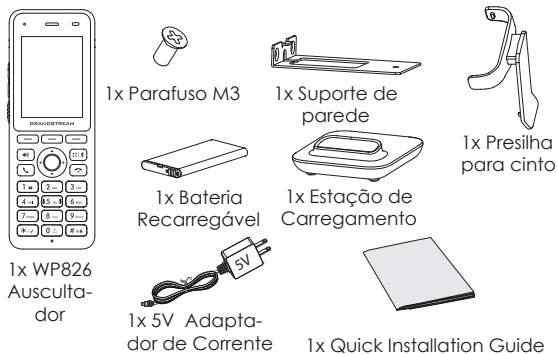

CONFIGURANDO O WP826

Estação de Carregamento:

Conecte a fonte de energia numa tomada para começar a utilizar a estação de carregamento da bateria.



Auscultador:

- Abrir a tampa da bateria.
- Insira a bateria com os eletrodos no canto superior direito.
- Fechar a tampa da bateria.

Aviso: Por favor carregue a bateria ao 100% antes de utilizar o dispositivo pela primeira vez.

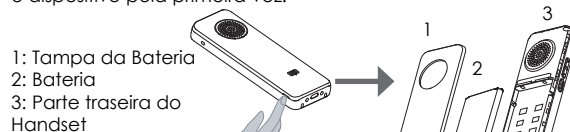

INSTALANDO O WP826 NA PAREDE

1. Retire o parafuso M3 da estação de carregamento e retire o suporte de parede
2. Faça furos na parede e insira os parafusos de expansão
3. Passe o parafuso através do suporte de parede e fixe-o na parede
4. Coloque a estação de carregamento e o suporte de parede juntos
5. Fixe a estação de carregamento e o suporte com parafuso M3
6. Insira o telefone na estação de carregamento

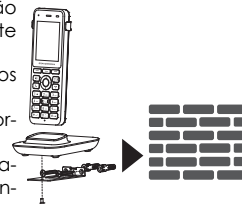

WP826 DESCRIPTION

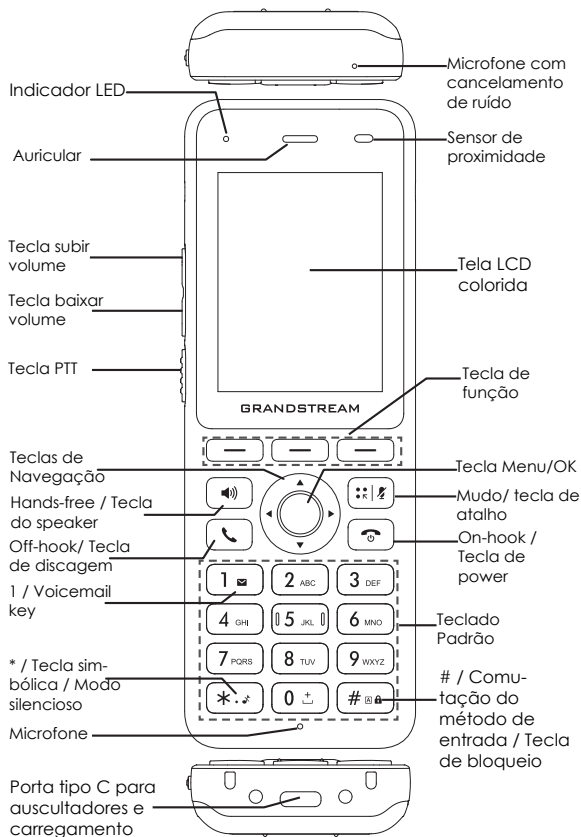

~39~

CONECTANDO O WP826 NA REDE WI-FI

1. No menu da tela LCD, pressione a tecla Menu e navegue até Settings → Wi-Fi Settings.
2. Configure o Wi-Fi como "On" e navegue até "Wi-Fi Network". A lista de redes Wi-Fi disponíveis será exibida.
3. Selecione a rede onde deseja conectar o dispositivo. (Coloque a senha de maneira correta no caso de ser preciso)

O WP826 exibirá o ícone Wi-Fi na tela inicial se a conexão na rede Wi-Fi for finalizada com sucesso.

ACESSANDO À INTERFACE WEB DO WP826

1. Pressione a tecla ACIMA para consultar o endereço IP.
 2. Digite o endereço IP do telefone no seu navegador de PC.
- Aviso:** O computador deve estar na mesma rede que o WP826.

3. Coloque o ID e a senha do administrador para acessar o menu de configuração. (O ID de usuário padrão é "admin", a senha de acesso aleatória pode ser encontrada na etiqueta na parte inferior do dispositivo).



Consulte os documentos em linha e os FAQ para informação mais detalhada: <http://www.grandstream.com/our-products>

~40~

Certification Regulatory Information

Common part

This equipment complies with radiation exposure limits set forth for an uncontrolled environment. This transmitter must not be co-located or operating in conjunction with any other antenna or transmitter.

Après examen de ce matériel aux conformités ou aux limites d'intensité de champ RF, les utilisateurs peuvent demander d'acquérir les informations correspondantes sur l'exposition aux radiofréquences et la conformité.

The earpiece is easy to absorb small object, please take care to avoid scratching.

U.S. FCC Part 68 Regulatory Information

This equipment is hearing aid compatible.

This equipment complies with Part 68 of the FCC rules. Located on the equipment is a label that contains, among other information, the ACTA registration number and ringer equivalence number (REN.) If requested, this information must be provided to the telephone company.

The REN is used to determine the quantity of devices which may be connected to the telephone line. Excessive REN's on the telephone line may result in the devices not ringing in response to an incoming call. In most, but not all areas, the sum of the REN's should not exceed five (5.0). To be certain of the number of devices that may be connected to the line, as determined by the total REN's contact the telephone company to determine the maximum REN for the calling area.

This equipment cannot be used on the telephone company-provided coin service. Connection to Party Line Service is subject to State Tariffs. If this equipment causes harm to the telephone network, the telephone company will notify you in advance that temporary discontinuance of service may be required. If advance notice isn't practical, the telephone company will notify the customer as soon as possible. Also, you will be advised of your right to file a complaint with the FCC if you believe it is necessary.

The telephone company may make changes in its facilities, equipment, operations, or procedures that could affect the operation of the equipment. If this happens, the telephone company will provide advance notice in order for you to make the necessary modifications in order to maintain uninterrupted service.

If the trouble is causing harm to the telephone network, the telephone company may request you to remove the equipment from the network until the problem is resolved.

This equipment uses the following USOC jacks: NA.

It is recommended that the customer install an AC surge arrester in the AC outlet to which this device is connected. This is to avoid damaging the equipment caused by local lightning strikes and other electrical surges.

If trouble is experienced with this equipment, please contact (Agent in the US):

Company Name: Grandstream Networks, Inc.
Address: 126 Brookline Ave, 3rd Floor Boston, MA 02215, USA
Tel: 1-617-5669300

U.S. FCC Part 15 Regulatory Information

This device complies with part 15 of the FCC Rules. Operation is subject to the following two conditions: (1) this device may not cause harmful interference, and (2) this device must accept any interference received, including interference that may cause undesired operation.

Any Changes or modifications not expressly approved by the party responsible for compliance could void the user's authority to operate the equipment.

Note: This equipment has been tested and found to comply with the limits for a Class B digital device, pursuant to part 15 of the FCC Rules. These limits are designed to provide reasonable protection against harmful interference in a residential installation. This equipment generates, uses and can radiate radio frequency energy and, if not installed and used in accordance with the instructions, may cause harmful interference to radio communications. However, there is no guarantee that interference will not occur in a particular installation. If this equipment does cause harmful interference to radio or television reception, which can be determined by turning the equipment off and on, the user is encouraged to try to correct the interference by one or more of the following measures:

- Reorient or relocate the receiving antenna.
 - Increase the separation between the equipment and receiver.
 - Connect the equipment into an outlet on a circuit different from that to which the receiver is connected.
 - Consult the dealer or an experienced radio/TV technician for help.
- The SAR limit of USA (FCC) is 1.6 W/kg averaged over one gram of tissue. This model (FCC ID: YZZWP826) has also been tested against this SAR limited.

The highest SAR value reported under this standard during product certification for use at the head is 0.68 W/kg and Body-worn is 1.34 W/kg. Body-worn SAR testing was worn on the belt clip at a separation distance of 1.0 cm. To meet RF exposure guidelines during body-worn operation, the device should be used with the belt clip.

Canada Regulatory Information

Radio equipment

Operation of 5150-5350 MHz is restricted to indoor use only. This device contains licence-exempt transmitter(s)/receiver(s) that comply with Innovation, Science and Economic Development Canada's licence-exempt RSS(s). Operation is subject to the following two conditions:

(1) This device may not cause interference.

(2) This device must accept any interference, including interference that may cause undesired operation of the device.

L'émetteur/récepteur exempt de licence contenu dans le présent appareil est conforme aux CNR d'Innovation, Sciences et Développement économique du Canada applicables aux appareils radio exempts de licence. L'exploitation est autorisée aux deux conditions suivantes :

1) L'appareil ne doit pas produire de brouillage;

2) L'appareil doit accepter tout brouillage radioélectrique subi, même si le brouillage est susceptible d'en compromettre le fonctionnement. The SAR limit of Canada (IC) is 1.6 W/kg averaged over one gram of tissue. This model (IC: 11964A-WP826) has also been tested against this SAR limited.

The highest SAR value reported under this standard during product certification for use at the head is 0.61 W/kg and body is 0.72 W/kg. Body-worn SAR testing was worn on the belt clip at a separation distance of 1.0 cm. To meet RF exposure guidelines during body-worn operation, the device should be used with the belt clip.

CAN ICES-003 (B)/NMB-003(B)

This product meets the applicable Innovation, Science and Economic Development Canada technical specifications.

Le présent produit est conforme aux spécifications techniques applicables d'Innovation, Sciences et Développement économique du Canada.

Terminal equipment

This product meets the applicable Innovation, Science and Economic Development Canada technical specifications.

The Ringer Equivalence Number (REN) indicates the maximum number of devices allowed to be connected to a telephone interface. The termination of an interface may consist of any combination of devices subject only to the requirement that the sum of the RENs of all the devices not exceed five.

Le présent produit est conforme aux spécifications techniques applicables d'Innovation, Sciences et Développement économique du Canada.

Le nombre équivalent de sonneries (REN) indique le nombre maximal de terminaux qui peuvent être raccordés à une interface téléphonique. La terminaison d'une interface peut consister en une combinaison de dispositifs, à la seule condition que la somme des REN de tous les dispositifs ne dépasse pas cinq.

EU Regulatory Information

In all EU member states, operation of 5150-5350 MHz is restricted to indoor use only.

Support Frequency Bands and Power:

Bluetooth/ BLE 2402-2480MHz<10dBm;

Support Frequency Bands and Power:

Bluetooth/ BLE 2402-2480MHz<10dBm;

WLAN 2412-2472 MHz < 20 dBm;

RLAN 5150-5250 MHz < 23 dBm;

RLAN 5250-5350 MHz < 20 dBm;

RLAN 5470-5725 MHz < 20 dBm;

WLAN 5725-5850 MHz < 14 dBm;

The body SAR limit of EU is 2 W/kg@10g averaged over one gram of tissue. This model WP826 has also been tested against this SAR limited.

The highest SAR value reported under this standard during product certification for use at the body is 0.45 W/kg@10g (5 mm Separation Distance), head is 0.20 W/kg@10g and limbs is 0.64 W/kg@10g(0 mm Separation Distance).

The simplified EU declaration of conformity referred to in Article 10(9) shall be provided as follows:

Hereby, [Grandstream Networks, Inc.] declares that the radio equipment type [WP826] is in compliance with Directive 2014/53/EU.

The full text of the EU declaration of conformity is available at the following internet address: www.grandstream.com