

# **Indoor Network PTZ Dome Cameras**

## Quick Guide

Manual Version: V1.00

Thank you for purchasing our product. If there are any questions, or requests, please do not hesitate to contact the dealer.

## Copyright

Copyright 2015 Zhejiang Uniview Technologies Co., Ltd. All rights reserved. No part of this manual may be copied, reproduced, translated, or distributed in any form or by any means without prior consent in writing from our company.

## Trademark Acknowledgement

 and other Uniview's trademarks and logos are the property of Zhejiang Uniview Technologies Co., Ltd. Other trademarks, company names and product names contained in this manual are the property of their respective owners.

## Disclaimer



The default password is used for your first login. To ensure account security, please change the password after your first login. You are recommended to set a strong password (no less than eight characters).

- To the maximum extent permitted by applicable law, the product described, with its hardware, software, firmware and documents, is provided on an "as is" basis.
- Best effort has been made to verify the integrity and correctness of the contents in this manual, but no statement, information, or recommendation in this manual shall constitute formal guarantee of any kind, expressed or implied. We shall not be held responsible for any technical or typographical errors in this manual. The contents of this manual are subject to change without prior notice. Update will be added to the new version of this manual.
- Use of this manual and product and the subsequent result shall be entirely on your own responsibility. In no event shall we be reliable to you for any special, consequential, incidental, or indirect damages, including, among others, damages for loss of business profits, business interruption, or loss of data or documentation, or product malfunction or

information leakage caused by cyber attack, hacking or virus in connection with the use of this product.

- Video and audio surveillance can be regulated by laws that vary from country to country. Check the law in your local region before using this product for surveillance purposes. We shall not be held responsible for any consequences resulting from illegal operations of the device.
- The illustrations in this manual are for reference only and may vary depending on the version or model. As a result, some of the examples and functions featured may differ from those displayed on your monitor.
- This manual is a guide for multiple product models and so it is not intended for any specific product.
- Due to uncertainties such as physical environment, discrepancy may exist between the actual values and reference values provided in this manual. The ultimate right to interpretation resides in our company.



## Environmental Protection

This product has been designed to comply with the requirements on environmental protection. For the proper storage, use and disposal of this product, national laws and regulations must be observed.



## Safety and Compliance Information

### Safety Symbols

The symbols in the following table may be found on installation-related equipment. Be aware of the situations indicated and take necessary safety precautions during equipment installation and maintenance.

Symbol	Description
	Generic alarm symbol: To suggest a general safety concern.
	ESD protection symbol: To suggest electrostatic-sensitive equipment.
	Electric shock symbol: To suggest a danger of high voltage.

The symbols in the following table may be found in this manual. Carefully follow the instructions indicated by the symbols to avoid hazardous situations and use the product properly.

Symbol	Description
	<b>WARNING!</b> Indicates a hazardous situation which, if not avoided, could result in bodily injury or death.
	<b>CAUTION!</b> Indicates a situation which, if not avoided, could result in damage, data loss or

Symbol	Description
	malfunction to product.
	<b>NOTE!</b> Indicates useful or supplemental information about the use of product.

## Safety Information

Installation and removal of the unit and its accessories must be carried out by qualified personnel. Please read all of the safety instructions below before installation and operation.

### Installation

- This device is a class A product and may cause radio interference. Take measures if necessary.
- If the product does not work properly, please contact your dealer. Never attempt to disassemble the camera yourself. (We shall not assume any responsibility for problems caused by unauthorized repair or maintenance.)
- Avoid squashing, shaking, or damping the camera during transport, storage, and mounting. Keep the camera from vibration sources during mounting.
- Please make sure that the ceiling can support more than 50(N) Newton gravities if the camera is fixed to the ceiling.

- Make sure the power supply voltage is correct before using the camera. Use a proper power adapter or a PoE power supply device. An improper power adapter may damage your camera.
- Disconnect the power before moving the camera, and take cautions to avoid electric shock when moving it. Once the cable is connected to the mains, the camera will be powered.
- During mounting, do not remove the protective film in the outer layer of housing to keep it clean. After finishing the mounting, remove the film when camera is powered off.
- Verify that the length of the power cable between the power adapter and the camera does not exceed 1.5 m. If the power cable is longer than 1.5 m, the voltage of the camera is lowered, causing the camera to work improperly. If it is required to lengthen the power cable, lengthen the cable between the power adapter and the mains.
- Do not hold the tail cable by hand for weight bearing. Otherwise, the cable connector of the camera could be loosened.
- Do not cut off the tail cable for connection purposes. A bare tail cable may easily cause a short circuit, resulting in abnormality of or damage to the camera.

- Use the waterproof tapes to protect the end of tail cable, and keep the tail cable from water.
- When connecting to an external interface, use an existing connection terminal, and ensure that the cable terminal (latch or buckle) is in good condition and properly fastened. Ensure that the cable is not tense during mounting, with a proper margin reserved to avoid poor port contact or loosening caused by shock or shake.
- Ensure that the high-level signal of the alarm input is not higher than 5 VDC when the alarm input interface is connected.
- As is often the case in the industry, dome housings tend to have static electricity. To prevent dust absorption by the static electricity, it is recommended to clean the dome housing surface with antistatic gloves after removing the protective film.
- Do not touch sensor modules with fingers. If cleaning is necessary, use a clean cloth with a bit of ethanol and wipe it gently. If the camera will not be used for an extended period of time, put on the lens cap to protect the sensor from dirt.
- Do not aim the camera lens at the strong light such as sun or incandescent lamp. The strong light can cause fatal damage to the camera.



- The sensor may be burned out by a laser beam, so when any laser equipment is being used, make sure that the surface of the sensor not be exposed to the laser beam.
- Ensure that the camera is stably mounted (especially when it is mounted on the wall or ceiling). Use the safety rope to prevent the camera from falling when mounting the camera.

### **Maintenance**

- If there is dust on the transparent dome cover, remove the dust gently using an oil-free brush or a rubber dust blowing ball.
- If there is grease or a dust stain on the transparent dome cover, clean the cover gently from the center outward using anti-static gloves or an oil-free cloth. If the grease or the stain still cannot be removed, use anti-static gloves or an oil-free cloth dipped with detergent and clean the dome cover gently until it is removed.
- Do not use organic solvents, such as benzene or ethanol when cleaning the transparent dome cover.



- Never look at the transmit laser while the power is on. Never look directly at the fiber ports and the fiber cable ends when they are powered on.
- Use of controls or adjustments to the performance or procedures other than those specified herein may result in hazardous laser emissions.

## Regulatory Compliance

### FCC Part 15

This equipment has been tested and found to comply with the limits for digital device, pursuant to part 15 of the FCC Rules. These limits are designed to provide reasonable protection against harmful interference when the equipment is operated in a commercial environment. This equipment generates, uses, and can radiate radio frequency energy and, if not installed and used in accordance with the instruction manual, may cause harmful interference to radio communications. Operation of this equipment in a residential area is likely to cause harmful

interference in which case the user will be required to correct the interference at his own expense.

This product complies with Part 15 of the FCC Rules. Operation is subject to the following two conditions:

1. This device may not cause harmful interference.
2. This device must accept any interference received, including interference that may cause undesired operation.

### LVD/EMC Directive



This product complies with the European Low Voltage Directive 2006/95/EC and EMC Directive 2004/108/EC.

## WEEE Directive–2002/96/EC



The product this manual refers to is covered by the Waste Electrical & Electronic Equipment (WEEE) Directive and must be disposed of in a responsible manner.

# Contents

---

<b>1 Appearance Description.....</b>	<b>1</b>
Dimensions and Appearance .....	1
Cable Connection .....	1
<b>2 Mount Your Camera .....</b>	<b>4</b>
Hardware Installation .....	4
Insert the SD Card (Optional) .....	4
Ceiling Mount.....	5
In-Ceiling Mount .....	10
Start the Camera .....	17
Waterproof Measures.....	18
Waterproof Components for an RJ45 Plug .....	18
Waterproof Tail Cable .....	20

<b>3 Set Your Camera over the LAN .....</b>	<b>23</b>
<b>4 Access Your Camera .....</b>	<b>24</b>
System Requirements for Your PC .....	24
Access Your Camera .....	25
Install the ActiveX .....	26
Adjust the Display .....	28

# 1 Appearance Description

---

## Dimensions and Appearance

**Figure 1** Front View of an Indoor PTZ Dome Camera

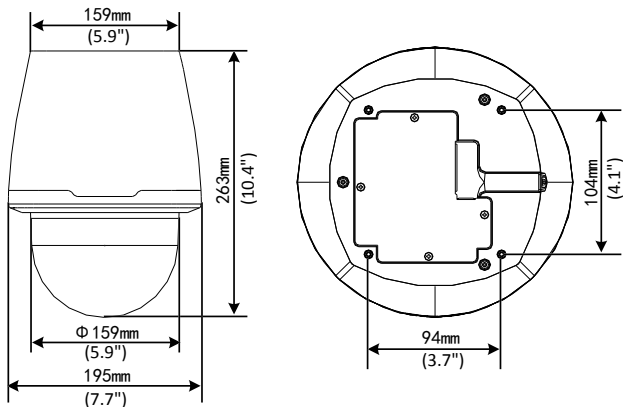

## Cable Connection

All the cables are tagged to indicate their functions. This section takes full tail cable as an example. You can connect cables by

referring to the following figure. The actual cable connection may vary with your camera model.

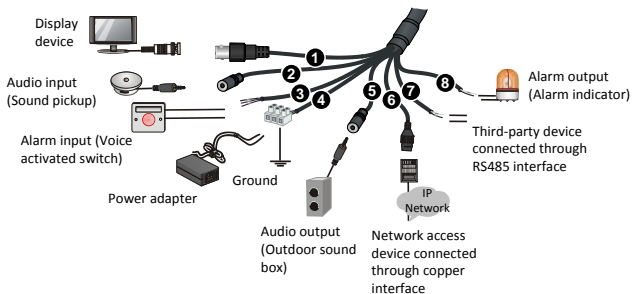

No.	Interface	Function
1	VIDEO OUT	Video output interface. Connect to analog devices such as monitors for video display.
2	AUDIO IN	Audio input interface. Input audio signals or performs intercom. <b>Note:</b> This interface can be used in either audio input or intercom.
3	ALARM IN	Alarm input interface. Input alarm signals.



No.	Interface	Function
4	Power interface	Connect the power adaptor.
5	AUDIO OUT	Output audio signals.
6	Ethernet interface	100M/1000M Base-TX adaptive Ethernet interface. Connect to the network.
7	RS485	Interact and control an external device. For example, it can control a third-party device.
8	ALARM OUT	Output alarm signals.



For the latest specifications, see the datasheet.

## 2 Mount Your Camera

---

### Hardware Installation

#### Insert the SD Card (Optional)

The SD card is located inside the camera. To install the SD card, you need to remove the bubble first. Do not hot plug the Micro SD card after it is inserted. Otherwise the camera or the SD card might be damaged.



For details about recommended SD card specifications, contact your dealer.

1. Unscrew the bubble by removing the three inner hexagon screws along the bubble edge.

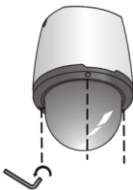

2. Insert the SD card into the slot and reinstall the bubble.



## Ceiling Mount

You can mount the camera if the wall and ceiling can bear common self-tapping screws and the camera weight. The ceiling bracket is delivered with the camera.

- 1.** Locate the positions of the holes. Verify that the holes on the wall align with the inner holes of the ceiling bracket.
  - a.** Lead the cable through the hole on the wall.
  - b.** Mark the holes by referring to mount points of the ceiling bracket.

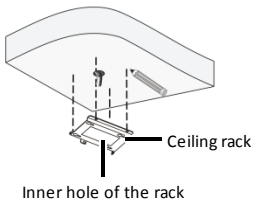

- 2.** Drill holes (depth: about 30 mm) on the wall by using a drill bit of the diameter 6 mm or 6.5 mm.

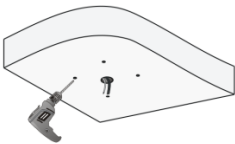

3. Mount the plastic rivets of self-tapping screws, knock the plastic rivets into the guide holes and ensure that they are tightened up.

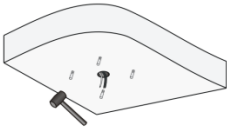

4. Mount the ceiling bracket by fastening the self-tapping screws through the bracket guide holes to the ceiling.

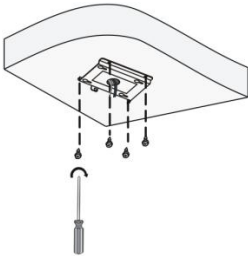

5. Mount the dome and the adapter bracket. Align the four screws of the adapter bracket with the mount points of the dome, and tighten the screws by using a screwdriver.

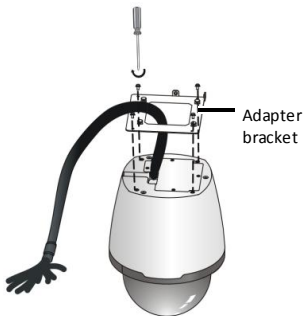

6. Fasten one end of the safety rope to the adapter bracket hole.



7. Fasten the other end of the safety rope to the ceiling bracket, and connect all cables.
  - a. Align the four stepped screws of the adapter bracket with the large hardy holes, and push the stepped screws upwards.
  - b. Push the stepped screws towards the small hardy holes, verify that the adapter bracket is firmly fixed to the ceiling bracket, and tighten the captive screws.

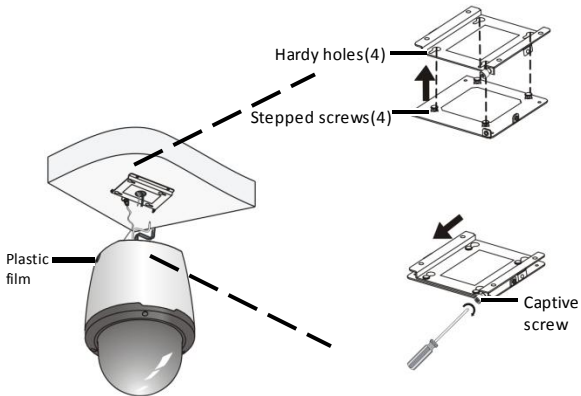



- The preceding installation process is concealed installation, during which the tail cable is led out from the top of the camera. If open installation is adopted, the tail cable is led out from one side of the camera and can be routed from one side where a piece of plastic film is broken off.
- After connecting the tail cable, perform waterproof treatment for the tail cable by using waterproof tapes.

## In-Ceiling Mount

In-ceiling mount is usually used in indoors applications for suspended ceilings. You need to purchase an in-ceiling bracket separately for in-ceiling mount. For details about the bracket model, see the recommended list provided by your dealer.

### **Check Before Mount**

- Ensure that the space beyond the suspended ceiling is at least 300 mm high, and the suspended ceiling is 10–40 mm thick. Otherwise, the in-ceiling bracket cannot be properly mounted to the ceiling.



- Ensure that the ceiling can bear the weight of the camera and the in-ceiling bracket. Otherwise, it is recommended to consolidate the ceiling by using a customized mounting kit.

### Steps

1. Drill a hole in the ceiling.
  - a. Paste a hole positioning sticker of the in-ceiling bracket onto the ceiling.
  - b. Drill a proper-sized hole in the ceiling.

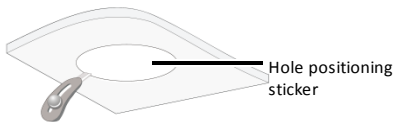

2. Put the inside bracket through the hole of the ceiling and align the inner edge of the bracket with the edge of the hole.

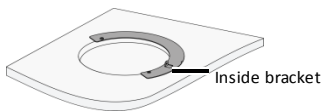

3. Fix the inside bracket and the outside bracket, align the two screw holes on the outside bracket with the hole positions on the inside bracket, fasten the two screws using a screwdriver, and verify that the inside bracket and the outside bracket have been fixed.

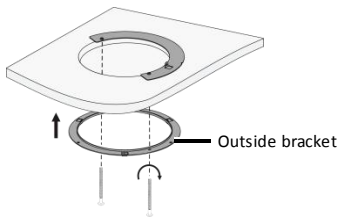

4. Mount the dome to the adapter bracket.
  - a. Lead the tail cable of the dome through the adapter bracket or out of the top hole of the adapter bracket. Then, push the dome to the adapter bracket from bottom to top.
  - b. Tighten the four screws on the top by using a screwdriver.

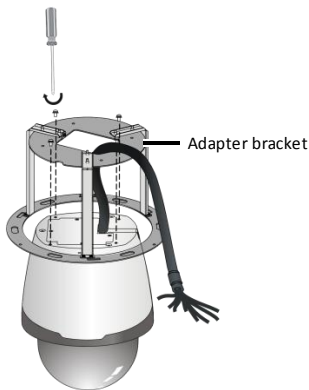

5. Fix one end of the safety rope to a hole on the adapter bracket.



6. Mount the dome to the ceiling.
- Hang the other end of the safety rope onto the inside bracket on the ceiling as shown by ❶ in the following figure.
  - Connect all cables between the ceiling and the tail cable of the dome as shown by ❷ in the following figure.
  - Slowly push the adapter bracket carrying the dome upward into the ceiling as shown by ❸ in the following figure.

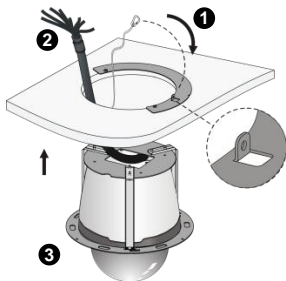

7. Fasten the adapter bracket and the outside bracket.
- Aim the three square holes on the adapter bracket to the three hooks on the outside bracket.
  - Turn the adapter bracket, so that the adapter bracket completely hangs on the hooks on the outside bracket.



- 8.** Tighten the locking screws on the adapter bracket by using a screwdriver, so as to fix the adapter bracket and prevent the adapter bracket from falling.

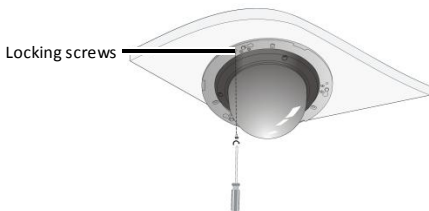

- 9.** Attach the plastic panel to the in-ceiling bracket and make sure only the bubble is visible from outside.



## Start the Camera

After verifying that the camera is properly mounted, start the camera by connecting it to power.

Each time the camera is powered on, it will perform a self-test to check the Pan/Tilt/Zoom (PTZ) function. After self-test, you can operate the camera.



- The self-test process starts after the camera is powered up. Please wait patiently.
- When the working temperature is lower than zero Celsius degrees, the camera will be automatically pre-heated. When the temperature rises above zero Celsius degrees, the camera will start the self-test again. It takes a rather long time (at most 30 minutes) for the camera to finish the pre-heating process.

## Waterproof Measures

### Waterproof Components for an RJ45 Plug

1. Attach the seal ring to the copper interface.

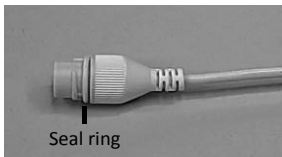

2. Mount the waterproof components.

You can crimp the inner wires of the cable with the RJ45 plug first and then cover the waterproof components. You may also cover the waterproof components first.

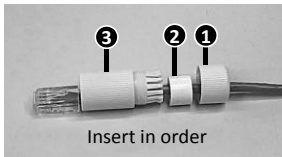



3. Insert the cylindrical waterproof ring into bolt.

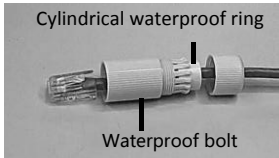

4. Insert the cable into the Ethernet copper interface and screw the waterproof bolt in.



5. Screw in the waterproof bolt lid.



6. Finish the waterproof installation.

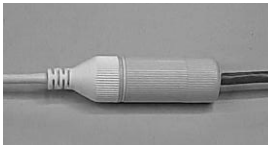

### Waterproof Tail Cable

Connect the tail cables and then take the following steps to protect the tail cables from water using waterproof tapes. The figures are only for illustration purpose.

1. Connect the tail cables.

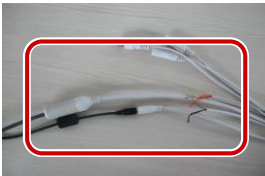

2. Protect the connected cables using insulating tapes.



3. Protect other cables using insulating tapes.



4. Wrap all the tail cables together using insulating tapes.



5. Choose a start point for waterproof tapes.



6. Protect the tail cables using waterproof tapes.





- Avoid short circuit when insulating the cables.
- Use self adhesive waterproof tapes that will stick together with the twisted cables.
- Tighten waterproof tapes when wrapping the cables and make sure the cable connections are fully covered.
- You are recommended to put the waterproof cables in a waterproof junction box which needs to be purchased separately.

## 3 Set Your Camera over the LAN

---

To view and configure your camera via the LAN (Local Area Network), you need to install the EZStation to find your camera and change its IP address.



- Please contact your dealer to get EZStation.
- Please refer to the EZStation user manual for detailed information.

1. Connect your camera and your PC as shown in the figure below to ensure the routing is available.



2. Use EZStation to search online cameras automatically.
3. Modify the camera settings if necessary, including its IP address and subnet mask.



- The default IP address is “192.168.0.13”. The default username is “admin” and the default password is “123456”.
- To access your camera from a different subnet, set the gateway for your camera after you log in.

## 4 Access Your Camera

---

### System Requirements for Your PC

Item	Requirements
Operating system	Microsoft Windows 8/Windows 7/Windows XP (32-bit or 64-bit). Microsoft Windows 7 is recommended.
CPU	2.0 GHz or higher, dual-core. Intel i3 CPU or higher

Item	Requirements
	are recommended.
Memory	At least 1 GB. 2 GB (or higher) is recommended.
Graphic card	<p>At least 128MB display memory. Mainstream discrete graphics with more than 1GB display memory are recommended. The hardware should support DirectX9.0c.</p> <p><b>Note:</b> Make sure that the latest driver is installed on graphic card.</p>
Sound card	<p>Required.</p> <p><b>Note:</b> The intercom and voice broadcast require the latest driver on sound card.</p>
Network card	Megabit Ethernet network cards (or higher) are recommended.

## Access Your Camera

Before you begin, check that:

- Your camera is operating properly and connected to the network.

- The PC client you are using is installed with Internet Explorer 7.0 or later. IE 8.0 is recommended.

Follow these steps to access your camera through the Web interface:

1. Open your browser, input the IP address of your camera (default IP is 192.168.0.13) in the address bar and then press **Enter** to open the login page.
2. Enter the username (default is “admin”) and password (default is “123456”) and then click **Login**.



Install the ActiveX at your first login. For the detailed steps, see [Install the ActiveX](#). When the installation of the ActiveX is completed, open your IE to log in.

## Install the ActiveX

The following takes the IE browser as an example to describe the installation steps.



1. Click **Download**.

 Failed to load ActiveX control, click [Download](#) to install latest ActiveX control.

2. Click **Run**. You may also click **Save** to download the file to your computer first.

3. Close the browser and follow the steps to complete the installation.



- For your first login with Windows 7, if the system does not prompt you to install ActiveX, follow these steps to turn off UAC: click the **Start** button, and then click **Control Panel**. In the search box, type **uac**, and then click **Change User Account Control Settings**. Move the slider to the **Never Notify** position, and then click **OK**. After UAC is turned off, log in again.
- If the installation failed, open **Internet Option** in IE before login. Click the **Security** tab, click **Trusted sites**, and then click **Sites** to add the website. If you use Windows 7, you need to save the setup.exe to your PC first, and then right-click the file, select **Run as administrator**, and then install it according to instructions.

## Adjust the Display

Enter the live view page, and then click the **Zoom** and **Focus** buttons to get clear image.

BOM: 3101C0BS