

# Grandstream Networks, Inc.

---

UCM6510 IP PBX

## User Manual



## **COPYRIGHT**

©2021 Grandstream Networks, Inc. <http://www.grandstream.com>. All rights reserved. Information in this document is subject to change without notice. Reproduction or transmittal of the entire or any part, in any form or by any means, electronic or print, for any purpose without the express written permission of Grandstream Networks, Inc. is not allowed.

The latest electronic version of this user manual is available for download here:

<http://www.grandstream.com/support>

Grandstream is a registered trademark and Grandstream logo is trademark of Grandstream Networks, Inc. in the United States, Europe and other countries.

## **CAUTION**

Changes or modifications to this product not expressly approved by Grandstream, or operation of this product in any way other than as detailed by this User Manual, could void your manufacturer warranty.

## **WARNING**

Please do not use a different power adaptor with your devices as it may cause damage to the products and void the manufacturer warranty.



## GNU GPL INFORMATION

UCM6510 firmware contains third-party software licensed under the GNU General Public License (GPL). Grandstream uses software under the specific terms of the GPL. Please see the GNU General Public License (GPL) for the exact terms and conditions of the license.

Grandstream GNU GPL related source code can be downloaded from Grandstream web site from:  
<http://www.grandstream.com/support/faq/gnu-general-public-license/gnu-gpl-information-download>



## Table of Content

<b>DOCUMENT PURPOSE.....</b>	<b>27</b>
<b>CHANGE LOG .....</b>	<b>28</b>
Firmware Version 1.0.20.38.....	28
Firmware Version 1.0.20.34.....	28
Firmware Version 1.0.20.31.....	28
Firmware Version 1.0.20.28.....	29
Firmware Version 1.0.20.23.....	29
Firmware Version 1.0.20.22.....	29
Firmware Version 1.0.20.20.....	29
Firmware Version 1.0.20.17.....	29
Firmware Version 1.0.19.29.....	34
Firmware Version 1.0.19.27.....	34
Firmware Version 1.0.19.21.....	35
Firmware Version 1.0.18.13.....	35
Firmware Version 1.0.18.12.....	35
Firmware Version 1.0.18.9.....	36
Firmware Version 1.0.17.16.....	36
Firmware Version 1.0.16.20.....	37
Firmware Version 1.0.16.18.....	37
Firmware Version 1.0.15.16.....	38
Firmware Version 1.0.14.24.....	39
Firmware Version 1.0.14.23.....	39
Firmware Version 1.0.14.21.....	39
Firmware Version 1.0.13.14.....	39
Firmware Version 1.0.12.19.....	40
Firmware Version 1.0.11.27.....	41
Firmware Version 1.0.10.44.....	42
Firmware Version 1.0.10.39.....	42
Firmware Version 1.0.2.7.....	42
Firmware Version 1.0.2.5.....	43
Firmware Version 1.0.1.12.....	43
Firmware Version 1.0.0.25.....	44
<b>WELCOME .....</b>	<b>45</b>
<b>PRODUCT OVERVIEW.....</b>	<b>46</b>





Feature Highlights .....	46
Technical Specifications .....	46
<b>INSTALLATION .....</b>	<b>49</b>
Equipment Packaging.....	49
Connect your UCM6510 .....	49
Safety Compliances.....	51
Warranty .....	51
<b>GETTING STARTED .....</b>	<b>52</b>
Use The LCD Menu .....	52
Use The LED Indicators .....	54
Using the Web UI .....	55
<i>Accessing the Web UI .....</i>	<i>55</i>
<i>Setup Wizard .....</i>	<i>56</i>
<i>Main Settings .....</i>	<i>57</i>
<i>Web GUI Languages .....</i>	<i>57</i>
<i>Web GUI Search Bar .....</i>	<i>58</i>
<i>Saving and Applying Changes.....</i>	<i>58</i>
Setting Up an Extension .....	59
<b>SYSTEM SETTINGS .....</b>	<b>60</b>
HTTP Server.....	60
Network Settings .....	61
<i>Basic Settings .....</i>	<i>61</i>
<i>DHCP Client List .....</i>	<i>66</i>
<i>802.1X .....</i>	<i>68</i>
<i>Static Routes .....</i>	<i>69</i>
<i>Port Forwarding .....</i>	<i>71</i>
OpenVPN®.....	73
DDNS Settings .....	75
Security Settings.....	77
<i>Static Defense .....</i>	<i>77</i>
<i>Dynamic Defense .....</i>	<i>80</i>
<i>Fail2ban .....</i>	<i>81</i>
<i>TLS Security .....</i>	<i>83</i>
<i>SSH Access .....</i>	<i>84</i>
LDAP Server.....	84
<i>LDAP Server Configurations.....</i>	<i>85</i>
<i>LDAP Phonebook .....</i>	<i>86</i>
<i>LDAP Client Configurations .....</i>	<i>90</i>



Time Settings .....	92
<i>Automatic Date and Time</i> .....	92
<i>Set Date and Time</i> .....	93
<i>NTP Server</i> .....	94
<i>Office Time</i> .....	94
<i>Holiday</i> .....	96
Email Settings .....	98
<i>Email Settings</i> .....	98
<i>Email Templates</i> .....	101
<i>Email Send Log</i> .....	103
Recordings Storage .....	104

## **PROVISIONING ..... 106**

Overview .....	106
Configuration Architecture for End Point Device .....	106
Auto Provisioning Settings .....	107
Discovery .....	110
Uploading Devices List .....	112
Managing discovered devices .....	113
Global Configuration .....	114
<i>Global Policy</i> .....	114
<i>Global Templates</i> .....	122
Model Configuration .....	124
<i>Model Templates</i> .....	124
<i>Model Update</i> .....	126
Device Configuration .....	127
<i>Create New Device</i> .....	127
<i>Manage Devices</i> .....	128
Example Application .....	135

## **EXTENSIONS ..... 140**

Create New User .....	140
<i>Create New SIP Extension</i> .....	140
<i>Create New IAX Extension</i> .....	149
<i>Create New FXS Extension</i> .....	153
Batch Add Extensions .....	158
<i>Batch Add SIP Extensions</i> .....	158
<i>Batch Add IAX Extensions</i> .....	161
Batch Extension Resetting Functionality .....	163
Search and Edit Extension .....	163
Export Extensions .....	165



Import Extensions .....	165
Extension Details .....	172
E-mail Notification .....	173
Multiple Registrations per Extension .....	175
SMS Message Support.....	176
<b>EXTENSION GROUPS.....</b>	<b>177</b>
Configure Extension Groups .....	177
Use Extension Groups.....	178
<b>ANALOG TRUNKS .....</b>	<b>179</b>
Analog Trunks Configuration .....	179
PSTN Detection .....	183
DAHDI and Analog Hardware Configuration .....	186
<b>DIGITAL TRUNKS .....</b>	<b>189</b>
Digital Hardware Configuration .....	189
Digital Trunk Configuration .....	199
Direct Outward Dialing (DOD) via Digital Trunks .....	200
Digital Trunk Troubleshooting .....	200
<b>DATA TRUNK.....</b>	<b>202</b>
<b>VOIP TRUNKS .....</b>	<b>204</b>
VoIP Trunk Configuration.....	204
Trunk Groups.....	215
Direct Outward Dialing (DOD) via VoIP Trunks .....	216
<b>SLA STATION .....</b>	<b>220</b>
Create/Edit SLA Station.....	220
Sample Configuration .....	221
<b>CALL ROUTES .....</b>	<b>223</b>
Outbound Routes .....	223
<i>Configuring Outbound Routes</i> .....	223
<i>Outbound Blacklist</i> .....	226
<i>Scheduled Sync</i> .....	228
<i>PIN Groups</i> .....	228
Inbound Routes .....	232
<i>Inbound Rule Configurations</i> .....	233
<i>Inbound Route: Prepend Example</i> .....	238



<i>Inbound Route: Multiple Mode</i> .....	239
<i>Inbound Route: Route-Level Mode</i> .....	240
<i>Inbound Route: Inbound Mode BLF Monitoring</i> .....	241
<i>Inbound Route: Import/Export Inbound Route</i> .....	243
<i>Fax with Two Media</i> .....	244

## **CONFERENCE.....246**

Conference room Configurations .....	246
Conference Call Operations .....	249
<i>Join a Conference Call</i> .....	249
<i>Invite Other Parties to Join Conference</i> .....	249
<i>During The Conference</i> .....	250
Google Service Settings Support .....	251
Conference Schedule .....	253
<i>Cleaner Options</i> .....	256
Contact Group .....	257
<i>Contact Group Configurations</i> .....	258
Conference Recordings.....	258
Conference Call Statistics .....	259

## **VIDEO CONFERENCE.....260**

Video Conference Room Configurations.....	260
Conference Settings .....	261
Conference Schedule .....	262
Wave WebRTC Video Calling & Conferencing.....	263

## **IPVIDEOTALK MEETINGS .....266**

## **IVR .....269**

Configure IVR .....	269
IVR Black/Whitelist .....	272
Create Custom Prompt.....	275

## **VOICE PROMPT .....276**

Language Settings.....	276
<i>Download and Install Voice Prompt Package</i> .....	276
<i>Upload Language Package</i> .....	278
Custom Prompt.....	279
<i>Record New Custom Prompt</i> .....	279
<i>Upload Custom Prompt</i> .....	279
<i>Download All Custom Prompt</i> .....	280



Username Prompt Customization .....	280
<i>Upload Username Prompt File from Web GUI</i> .....	280
<i>Record Username via Voicemail Menu</i> .....	281
<b>VOICEMAIL.....</b>	<b>282</b>
Configure Voicemail.....	282
Access Voicemail.....	284
Leaving Voicemail.....	286
Voicemail Email Settings .....	286
Configure Voicemail Group.....	287
<b>RING GROUP.....</b>	<b>289</b>
Configure Ring Group.....	289
Remote Extension in Ring Group.....	292
<b>RESTRICT CALLS .....</b>	<b>295</b>
<b>PAGING AND INTERCOM GROUP .....</b>	<b>296</b>
Configure Paging/Intercom Group.....	296
<i>Configure Multicast Paging</i> .....	296
<i>Configure 2-way Intercom</i> .....	297
<i>Configure 1-way Paging</i> .....	298
<i>Configure Announcement Paging</i> .....	299
<i>Configure Private Intercom</i> .....	300
<i>Paging/Intercom Group Settings</i> .....	302
Configure a Scheduled Paging/Intercom.....	302
<b>CALL QUEUE .....</b>	<b>304</b>
Configure Call Queue .....	304
Call Center Settings & Enhancements .....	309
Queue Statistics .....	311
<i>Agent Details</i> .....	312
<i>Login Record</i> .....	313
<i>Pause Log</i> .....	313
Switchboard.....	315
<b>PICKUP GROUPS.....</b>	<b>318</b>
Configure Pickup Groups .....	318
Configure Pickup Feature Code .....	318
<b>MUSIC ON HOLD.....</b>	<b>320</b>



<b>FAX SERVER.....</b>	<b>323</b>
Configure Fax/T.38 .....	323
Receiving FAX .....	325
<i>Example Configuration to Receive Fax from PSTN Line .....</i>	<i>325</i>
<i>Example Configuration for Fax-To-Email.....</i>	<i>328</i>
Fax Sending .....	329
<b>BUSY CAMP-ON.....</b>	<b>331</b>
<b>PRESENCE.....</b>	<b>332</b>
<b>FOLLOW ME.....</b>	<b>335</b>
<b>SPEED DIAL .....</b>	<b>338</b>
<b>DISA.....</b>	<b>339</b>
<b>EMERGENCY.....</b>	<b>341</b>
<b>CALLBACK.....</b>	<b>344</b>
<b>BLF AND EVENT LIST.....</b>	<b>346</b>
BLF .....	346
Event List.....	346
<b>DIAL BY NAME.....</b>	<b>349</b>
Dial By Name Configuration .....	349
Username Prompt Customization .....	352
<i>Upload Username Prompt File from Web GUI .....</i>	<i>352</i>
<i>Record Username via Voicemail Menu .....</i>	<i>353</i>
<b>ACTIVE CALLS AND MONITOR .....</b>	<b>354</b>
Active Calls Status.....	354
Hang Up Active Calls.....	356
Call Monitor .....	356
<b>CALL FEATURES CODES.....</b>	<b>358</b>
Feature Codes.....	358
Parking Lot .....	363
Call Park .....	365



<i>Park a Call</i> .....	365
<i>Retrieve Parked Call</i> .....	365
<i>Monitor Call Park CID Name Information (GXP21xx Phones Only)</i> .....	366
Call Recording .....	366
Enable Spy .....	367
Shared Call Appearance (SCA) .....	367
Announcement .....	371
<b>PBX SETTINGS .....</b>	<b>374</b>
General Settings .....	374
Call Failure Tone Settings .....	376
<i>SIP Trunk Prompt Tone</i> .....	376
<i>General Call Failure Tone</i> .....	377
PBX Settings/Jitter Buffer .....	378
PBX Settings/RTP Settings .....	378
<i>RTP Settings</i> .....	378
<i>Payload</i> .....	379
PBX Settings/NAS .....	380
<b>IAX SETTINGS .....</b>	<b>381</b>
IAX Settings/General .....	381
IAX Settings/Registration .....	381
IAX Settings/Security .....	382
<b>SIP SETTINGS .....</b>	<b>383</b>
SIP Settings/General .....	383
SIP Settings/Misc .....	383
SIP Settings/Session Timer .....	385
SIP Settings/TCP and TLS .....	385
SIP Settings/NAT .....	386
SIP Settings/TOS .....	386
Transparent Call-Info header .....	388
<b>GDMS SETTINGS .....</b>	<b>389</b>
<b>API CONFIGURATION .....</b>	<b>392</b>
HTTPS API (New) .....	392
HTTPS API (Old) .....	393
CDR Real-time Output Settings .....	394
<b>CTI SERVER .....</b>	<b>396</b>



<b>ASTERISK MANAGER INTERFACE (RESTRICTED ACCESS).....</b>	<b>397</b>
<b>CRM INTEGRATION .....</b>	<b>398</b>
SugarCRM .....	398
vTigerCRM.....	399
ZohoCRM .....	401
Salesforce CRM .....	403
ACT! CRM .....	404
<b>PMS INTEGRATION.....</b>	<b>406</b>
HMobile PMS Connector .....	406
HSC PMS .....	407
Mitel PMS .....	408
PMS API .....	409
Connecting to PMS.....	410
PMS Features.....	411
<i>Room Status</i> .....	411
<i>Wake Up Service</i> .....	412
<i>Mini Bar</i> .....	413
<b>WAKEUP SERVICE .....</b>	<b>416</b>
Wakeup Service using Admin Login .....	416
Wakeup Service from User Portal .....	417
Wakeup Service using Feature Code.....	418
<b>ANNOUNCEMENTS CENTER.....</b>	<b>419</b>
Announcements Center Setting .....	419
Group Setting .....	420
<b>QUEUOMETRICS INTEGRATION.....</b>	<b>422</b>
API Configuration Parameters.....	422
<b>STATUS AND REPORTING .....</b>	<b>424</b>
PBX Status .....	424
<i>Trunks</i> .....	424
<i>Extensions</i> .....	426
<i>Interfaces Status</i> .....	427
System Status .....	429
<i>General</i> .....	429
<i>Network</i> .....	430





Storage Usage .....	430
Resource Usage .....	431
System Events.....	432
Alert Events List.....	432
Alert Log .....	434
Alert Contact.....	436
CDR.....	437
CDR Improvement .....	442
Downloaded CDR File .....	443
CDR Export Customization.....	444
Statistics .....	445
Recording Files.....	447
<b>USER PORTAL .....</b>	<b>448</b>
Basic Information.....	450
Personal Data.....	450
Value-added Features .....	450
Fax Sending.....	450
Call Queue.....	450
Wakeup Service.....	450
CRM User Settings.....	450
<b>HIGH AVAILABILITY .....</b>	<b>451</b>
Deployment Methods.....	451
HA100 Configuration .....	452
Upgrading HA100 .....	452
Upgrading UCM6510s Connected to the HA100 .....	453
<b>MAINTENANCE .....</b>	<b>454</b>
User Management.....	454
User Information .....	454
Custom Privilege.....	456
Concurrent Multi-User Login.....	459
Login Settings.....	460
Change Password .....	460
Change Username.....	461
Login Security .....	461
Operation Log.....	463
Upgrading .....	464
Upgrading via Network .....	464
Upgrading via Local Upload .....	466



<i>No Local Firmware Servers</i> .....	467
Backup .....	468
<i>Backup/Restore</i> .....	468
<i>Data Sync</i> .....	470
<i>Restore Configuration from Backup File</i> .....	472
System Cleanup/Reset .....	472
<i>Reset and Reboot</i> .....	472
<i>Cleaner</i> .....	473
<i>USB Disk/SD Card File Management</i> .....	477
System Recovery .....	478
Syslog .....	480
Network Troubleshooting .....	481
<i>Ethernet Capture</i> .....	481
<i>IP Ping</i> .....	482
<i>Traceroute</i> .....	482
Signaling Troubleshooting .....	483
<i>PRI/SS7/MFC/R2 Signaling Trace</i> .....	483
<i>Analog Record Trace</i> .....	483
<i>E&amp;M Immediate Record Trace</i> .....	485
<i>Service Check</i> .....	485
<i>Network Status</i> .....	486
<b>EXPERIENCING THE UCM6510 SERIES IP PBX .....</b>	<b>487</b>



## Table of Tables

Table 1: Technical Specifications .....	46
Table 2: UCM6510 Equipment Packaging .....	49
Table 3: LCD Menu Options .....	53
Table 4: UCM6510 LED Indicators.....	54
Table 5: HTTP Server Settings.....	60
Table 6: UCM6510 System Settings → Network Settings→Basic Settings.....	61
Table 7: UCM6510 Network Settings→802.1X.....	69
Table 8: UCM6510 Network Settings→Static Routes.....	69
Table 9: UCM6510 System Settings → Network Settings→Port Forwarding.....	71
Table 10: UCM6510 System Settings→Network Settings→OpenVPN®.....	73
Table 11: UCM6510 Security Settings→Static Defense→Current Service.....	78
Table 12: Typical Firewall Settings.....	78
Table 13: Firewall Rule Settings.....	79
Table 14: UCM6510 Firewall Dynamic Defense .....	80
Table 15: Fail2Ban Settings .....	83
Table 16: Auto Time Updating.....	93
Table 17: Create New Office Time .....	95
Table 18: Create New Holiday.....	97
Table 19: Email Settings.....	98
Table 20: Email Log.....	103
Table 21: Auto Provision Settings .....	109
Table 22: Global Policy Parameters – Localization.....	115
Table 23: Global Policy Parameters – Phone Settings .....	115
Table 24: Global Policy Parameters – Contact List.....	116
Table 25: Global Policy Parameters – Maintenance .....	118
Table 26: Global Policy Parameters – Network Settings .....	120
Table 27: Global Policy Parameters – Customization.....	120
Table 28: Global Policy Parameters – Communication Settings.....	121
Table 29: Create New Template .....	122
Table 30: Create New Model Template .....	124
Table 31: SIP Extension Configuration Parameters – Basic Settings.....	141
Table 32: SIP Extension Configuration Parameters – Media.....	143
Table 33: SIP Extension Configuration Parameters – Features .....	144
Table 34: SIP Extension Configuration Parameters – Specific Time .....	148
Table 35: IAX Extension Configuration Parameters – Basic Settings.....	149
Table 36: IAX Extension Configuration Parameters – Media.....	150
Table 37: IAX Extension Configuration Parameters – Features .....	151
Table 38: IAX Extension Configuration Parameters – Specific Time .....	153



Table 39: FXS Extension Configuration Parameters – Basic Settings .....	153
Table 40: FXS Extension Configuration Parameters – Media.....	154
Table 41: FXS Extension Configuration Parameters – Features .....	155
Table 42: FXS Extension Configuration Parameters – Specific Time.....	158
Table 43: Batch Add SIP Extension Parameters.....	158
Table 44: Batch Add IAX Extension Parameters.....	161
Table 45: SIP Extensions Imported File Example .....	166
Table 46: IAX extensions Imported File Example .....	168
Table 47: FXS extensions Imported File Example .....	170
Table 48: Analog Trunk Configuration Parameters .....	179
Table 49: PSTN Detection for Analog Trunk .....	185
Table 50: Analog Hardware Configuration Parameters.....	187
Table 51: Digital Hardware Configuration Parameters: E1 – PRI_NET/PRI_CPE .....	190
Table 52: Digital Hardware Configuration Parameters: E1 - SS7 .....	192
Table 53: Digital Hardware Configuration Parameters: E1 - MFC/R2 .....	193
Table 54: Digital Hardware Configuration Parameters: T1/J1 - PRI_NET/PRI_CPE.....	195
Table 55: Digital Hardware Configuration Parameters: T1/J1 - SS7.....	197
Table 56: Digital Hardware Configuration Parameters: T1-E&M Immediate/E&M Wink.....	198
Table 57: Digital Trunk Configuration Parameters .....	199
Table 58: Data Trunk Configuration Parameters.....	203
Table 59: Create New SIP Trunk.....	204
Table 60: SIP Register Trunk Configuration Parameters .....	205
Table 61: SIP Peer Trunk Configuration Parameters .....	209
Table 62: Create New IAX Trunk.....	212
Table 63: IAX Register Trunk Configuration Parameters .....	213
Table 64: IAX Peer Trunk Configuration Parameters .....	214
Table 65: SLA Station Configuration Parameters .....	220
Table 66: Outbound Route Configuration Parameters .....	223
Table 67: Blacklist Manage - Matching Rules .....	227
Table 68: Sync Outbound Routes .....	228
Table 69: Outbound Routes/PIN Group .....	228
Table 70: Inbound Rule Configuration Parameters.....	233
Table 71: Conference room Configuration Parameters .....	246
Table 72: Conference Settings.....	248
Table 73: Conference Caller IVR Menu .....	250
Table 74: Conference Schedule Parameters .....	253
Table 75: Contact Group Parameters .....	258
Table 76: Video Conference Room Configuration Parameters.....	260
Table 77: Video Conference Basic Settings.....	261
Table 78: Video Conference Schedule Parameters .....	262
Table 79: IVR Configuration Parameters .....	270



Table 80: Voicemail Settings .....	283
Table 81: Voicemail IVR Menu .....	284
Table 82: Voicemail Email Settings .....	286
Table 83: Voicemail Group Settings .....	287
Table 84: Ring Group Parameters .....	289
Table 85: Restrict Calls configuration Parameters .....	295
Table 86: Multicast Paging Configuration Parameters .....	297
Table 87: 2-way Intercom Configuration Parameters .....	298
Table 88: 1-way Paging Configuration Parameters .....	299
Table 89: Announcement Paging Configuration Parameters .....	300
Table 90: Private Intercom Configuration Parameters .....	301
Table 91: Schedule Paging / Intercom Settings .....	303
Table 92: Call Queue Configuration Parameters .....	304
Table 93: MaxStatic Agents in Call Queue .....	308
Table 94: Call Center Parameters .....	310
Table 95: Global Queue Settings .....	314
Table 96: Switchboard Parameters .....	316
Table 97: FAX/T.38 Settings .....	324
Table 98: SIP Presence Status .....	332
Table 99: Follow Me Settings .....	336
Table 100: Follow Me Options .....	337
Table 101: DISA Settings .....	339
Table 102: Emergency Numbers Parameters .....	342
Table 103: Callback Configuration Parameters .....	344
Table 104: Event List Settings .....	347
Table 105: UCM6510 Feature Codes .....	358
Table 106: Parking Lot .....	364
Table 107: Add SCA Private Number .....	370
Table 108: Editing the SCA Number .....	370
Table 109: Announcement Parameters .....	372
Table 110: PBX Settings/General .....	374
Table 111: Internal Options/Jitter Buffer .....	378
Table 112: Internal Options/RTP Settings .....	378
Table 113: Internal Options/Payload .....	379
Table 114: NAS Settings .....	380
Table 115: IAX Settings/General .....	381
Table 116: IAX Settings/Registration .....	381
Table 117: IAX Settings/Static Defense .....	382
Table 118: SIP Settings/General .....	383
Table 119: SIP Settings/Misc .....	383
Table 120: SIP Settings/Session Timer .....	385



Table 121: SIP Settings/TCP and TLS .....	385
Table 122: SIP Settings/NAT .....	386
Table 123: SIP Settings/ToS.....	386
Table 124: API Configuration Parameters .....	392
Table 125: New API Supported Queries .....	392
Table 126: API Configuration Parameters (Old).....	393
Table 127: CDR Real-time Output Settings .....	394
Table 128: SugarCRM Settings.....	398
Table 129: vTigerCRM Settings .....	400
Table 130: ZohoCRM Settings .....	402
Table 131: Salesforce Settings.....	404
Table 132: PMS Supported Features .....	406
Table 133: PMS Basic Settings .....	410
Table 134: PMS Wake up Service.....	412
Table 135: Create New Mini Bar .....	413
Table 136: Create New Maid.....	414
Table 137: Wakeup Service – Admin Login.....	417
Table 138: Max Wakeup Members.....	417
Table 139: Announcements Center Setting.....	419
Table 140: Group Setting .....	420
Table 141: QueueMetrics Configuration Parameters .....	423
Table 142: Trunk Status .....	425
Table 143: Extension Status.....	426
Table 144: Interface Status Indicators.....	427
Table 145: System Status→General .....	429
Table 146: System Status→Network.....	430
Table 147: Alert Events .....	432
Table 148: Alert Contact .....	436
Table 149: CDR Filter Criteria .....	438
Table 150: Automatic Download Settings.....	442
Table 151: CDR Statistics Filter Criteria.....	446
Table 152: System Settings→ HA→HA Settings .....	452
Table 153: User Management – Create New User .....	455
Table 154: Change Password .....	460
Table 155: Change Username .....	461
Table 156: Operation Log Column Header .....	463
Table 157: Network Upgrade Configuration .....	465
Table 158: Data Sync Configuration .....	471
Table 159: Cleaner Configuration .....	475
Table 160: USB/SD Card Files Cleanup .....	478
Table 161: Syslog Parameters .....	480



Table 162: Ethernet Capture ..... 481

## Table of Figures

Figure 1: UCM6510 Front View ..... 49

Figure 2: UCM6510 Back View ..... 49

Figure 3: UCM6510 T1/E1/J1 Crossover Cable Pin-out ..... 50

Figure 4: UCM6510 Web GUI Login Page ..... 55

Figure 5: UCM6510 Setup Wizard ..... 56

Figure 6: UCM6510 Web GUI Language ..... 58

Figure 7: Web GUI Search Bar ..... 58

Figure 8: UCM6510 Web GUI: Apply Changes ..... 59

Figure 9: UCM6510 Network Interface Method: Route ..... 65

Figure 10: UCM6510 Network Interface Method: Switch ..... 65

Figure 11: UCM6510 Network Interface Method: Dual ..... 66

Figure 12: DHCP Client List ..... 66

Figure 13: Add MAC Address Bind ..... 67

Figure 14: Batch Add MAC Address Bind ..... 67

Figure 15: UCM6510 using 802.1X as Client ..... 68

Figure 16: UCM6510 using 802.1X EAP-MD5 ..... 68

Figure 17: UCM6510 Static Route Sample ..... 70

Figure 18: UCM6510 Static Route Configuration ..... 71

Figure 19: Create New Port Forwarding ..... 72

Figure 20: UCM6510 Port Forwarding Configuration ..... 73

Figure 21: GXP2160 Web Access Using UCM6510 Port Forwarding ..... 73

Figure 22: OpenVPN® feature on the UCM6510 ..... 75

Figure 23: Register Domain Name on noip.com ..... 76

Figure 24: UCM6510 DDNS Setting ..... 76

Figure 25: Using Domain Name to Connect to UCM6510 ..... 77

Figure 26: Create New Firewall Rule ..... 79

Figure 27: Configure Dynamic Defense ..... 81

Figure 28: Fail2ban Settings ..... 82

Figure 29: TLS Security ..... 84

Figure 30: SSH Access ..... 84

Figure 31: LDAP Server Configurations ..... 85

Figure 32: Default LDAP Phonebook DN ..... 86

Figure 33: Default LDAP Phonebook Attributes ..... 86

Figure 34: LDAP Server→LDAP Phonebook ..... 87

Figure 35: Add LDAP Phonebook ..... 87



Figure 36: Edit LDAP Phonebook .....	88
Figure 37: Import Phonebook.....	88
Figure 38: Phonebook CSV File Format .....	88
Figure 39: LDAP Phonebook After Import.....	89
Figure 40: Export Selected LDAP Phonebook.....	89
Figure 41: LDAP Client Configurations .....	90
Figure 42: GXP2170 LDAP Phonebook Configuration .....	92
Figure 43: Set Time Manually .....	94
Figure 44: Create New Office Time.....	95
Figure 45: System Settings→Time Settings→Office Time.....	96
Figure 46: Create New Holiday .....	97
Figure 47: System Settings→Time Settings→Holiday.....	98
Figure 48: UCM6510 Email Settings.....	100
Figure 49: UCM6510 Email Settings: Send Test Email.....	101
Figure 50: Email Templates.....	101
Figure 51: Conference Schedule Template.....	102
Figure 52: Email Send log.....	103
Figure 53: Email Logs .....	104
Figure 54: PBX Settings→Recordings Storage .....	104
Figure 55: Recordings Storage Prompt Information .....	105
Figure 56: Recording Storage Category .....	105
Figure 57: Zero Config Configuration Architecture for End Point Device .....	107
Figure 58: UCM6510 Zero Config.....	108
Figure 59: Auto Provision Settings.....	109
Figure 60: Auto Discover.....	111
Figure 61: Auto Discover other subnets.....	112
Figure 62: Discovered Devices .....	112
Figure 63: Device list - CSV file sample.....	112
Figure 64: Managing Discovered Devices .....	113
Figure 65: Global Policy Categories .....	115
Figure 66: Edit Global Template.....	123
Figure 67: Edit Model Template .....	125
Figure 68: OEM Models .....	126
Figure 69: Template Management .....	127
Figure 70: Upload Model Template Manually.....	127
Figure 71: Create New Device.....	128
Figure 72: Manage Devices .....	129
Figure 73: Edit Device.....	129
Figure 74: Edit Customize Device Settings.....	131
Figure 75: Add P Value in Customize Device Settings .....	132
Figure 76: Modify Selected Devices–Same Model .....	133





Figure 77: Modify Selected Devices—Different Models.....	134
Figure 78: Device List in Zero Config.....	135
Figure 79: Zero Config Sample – Global Policy.....	136
Figure 80: Zero Config Sample – Device Preview 1.....	137
Figure 81: Zero Config Sample – Device Preview 2.....	138
Figure 82: Zero Config Sample – Device Preview 3.....	139
Figure 83: Create New Device.....	140
Figure 84: Manage Extensions.....	164
Figure 85: Export Extensions.....	165
Figure 86: Export Extensions.....	165
Figure 87: Import File.....	166
Figure 88: Import Error.....	172
Figure 89 : Extension Details.....	173
Figure 90: E-mail Notification Prompt Information.....	174
Figure 91: E-mail Notification: Account Registration Information and QR Code.....	174
Figure 92: E-mail Notification LDAP Client Information and QR Code.....	175
Figure 93: Multiple Registrations per Extension.....	175
Figure 94: Extension - Concurrent Registration.....	176
Figure 95: SMS Message Support.....	176
Figure 96: Edit Extension Group.....	177
Figure 97: Select Extension Group in Outbound Route.....	178
Figure 98: UCM6510 FXO Tone Settings.....	183
Figure 99: UCM6510 PSTN Detection.....	183
Figure 100: UCM6510 PSTN Detection: Auto Detect.....	184
Figure 101: UCM6510 PSTN Detection: Semi-Auto Detect.....	184
Figure 102: FXS Ports Signaling Preference.....	186
Figure 103: FXO Ports ACIM Settings.....	186
Figure 104: Dahdi Settings.....	188
Figure 105: Digital Hardware Configuration.....	189
Figure 106: Troubleshooting Digital Trunks.....	201
Figure 107: Data Trunk Web Page.....	202
Figure 108: Data Trunk Configuration.....	202
Figure 109: Trunk Group.....	215
Figure 110: Trunk Group Configuration.....	216
Figure 111: DOD extension selection.....	217
Figure 112: Edit DOD.....	218
Figure 113: Fax Sending DOD.....	218
Figure 114: DOD Import file.....	219
Figure 115: SLA Station.....	220
Figure 116: Enable SLA Mode for Analog Trunk.....	221
Figure 117: Analog Trunk with SLA Mode Enabled.....	221



Figure 118: SLA Example - SLA Station .....	222
Figure 119: SLA Example - MPK Configuration .....	222
Figure 120: Outbound Blacklist .....	227
Figure 121: Blacklist Import/Export .....	228
Figure 122: Create New PIN Group .....	229
Figure 123: PIN members .....	229
Figure 124: Outbound PIN .....	230
Figure 125: CDR Record .....	230
Figure 126: Importing PIN Groups from CSV files .....	231
Figure 127: Incorrect CSV File .....	231
Figure 128: CSV File Format .....	232
Figure 129: CSV File Successful Upload .....	232
Figure 130: Inbound Route feature: Prepend .....	238
Figure 131: Inbound Route - Multiple Mode .....	239
Figure 132: Inbound Route - Multiple Mode Feature Codes .....	240
Figure 133: Inbound Route - Route-Level Mode .....	241
Figure 134: Global Inbound Mode .....	242
Figure 135 : Inbound Mode - Default Mode .....	242
Figure 136 : Inbound Mode - Mode 1 .....	242
Figure 137: Import/Export Inbound Route .....	243
Figure 138: Blacklist Configuration Parameters .....	244
Figure 139: Blacklist csv File .....	245
Figure 140: Conference .....	248
Figure 141: Conference Invitation From Web GUI .....	249
Figure 142: Google Service Settings: OAuth2.0 Authentication .....	251
Figure 143: Google Service: New Project .....	252
Figure 144: Google Service: Create new credential .....	252
Figure 145: Google Service: OAuth2.0 login .....	253
Figure 146: Conference Schedule .....	256
Figure 147: Contact Group Parameters .....	257
Figure 148: Conference Recording .....	258
Figure 149: Conference Call Statistics .....	259
Figure 150: Conference Report on Web .....	259
Figure 151: Conference Report on CSV .....	259
Figure 152 : Video Conference Basic settings .....	261
Figure 153: Video Conference Schedule .....	263
Figure 154 : Enabling WebRTC feature .....	264
Figure 155 : Enabling WebRTC on extensions .....	264
Figure 156: Grandstream Wave Interface .....	265
Figure 157: IPVT SIP Trunk page .....	266
Figure 158 - Peer Trunk to IPVT .....	266



Figure 159 - IPVT Mode.....	267
Figure 160 - IPVT Outbound Pattern .....	267
Figure 161 - IPVT Outbound Strip.....	268
Figure 162: Create New IVR.....	269
Figure 163: Key Pressing Events.....	272
Figure 164: Black/White List .....	274
Figure 165: Click on Prompt to Create IVR Prompt.....	275
Figure 166: Language Settings for Voice Prompt .....	276
Figure 167: Voice Prompt Package List.....	277
Figure 168: New Voice Prompt Language Added .....	277
Figure 169: Upload Voice Prompts Package .....	278
Figure 170: Record New IVR Prompt .....	279
Figure 171: Upload IVR Prompt.....	280
Figure 172: Download All Custom Prompt .....	280
Figure 173: Voicemail Settings.....	282
Figure 174: Voicemail Email Settings .....	286
Figure 175: Voicemail Group.....	287
Figure 176: Ring Group.....	289
Figure 177: Ring Group Configuration .....	292
Figure 178: Sync LDAP Server option .....	293
Figure 179: Manually Sync LDAP Server .....	293
Figure 180: Ring Group Remote Extension .....	294
Figure 181: Restrict Calls.....	295
Figure 182: Multicast Paging.....	296
Figure 183 : 2-way Intercom .....	297
Figure 184 : 1-way Paging .....	298
Figure 185 : Announcement Paging.....	299
Figure 186: Private Intercom.....	301
Figure 187: Page/Intercom Group Settings .....	302
Figure 188: Schedule Paging/Intercom page.....	302
Figure 189: Creating a Scheduled Paging/Intercom Call.....	303
Figure 190: Call Queue .....	304
Figure 191: Static Agents Limitation .....	308
Figure 192: Agent Login Settings .....	309
Figure 193: Call Queue Statistics .....	311
Figure 194 : Automatic Download Settings - Queue Statistics .....	312
Figure 195: Agent details .....	313
Figure 196: Login Record.....	313
Figure 197: Pause Log.....	314
Figure 198: Global Queue Settings.....	314
Figure 199 : Switchboard summary .....	315



Figure 200: Call Queue Switchboard .....	316
Figure 201: Queue Agent .....	317
Figure 202: Edit Pickup Group .....	318
Figure 203: Edit Pickup Feature Code .....	319
Figure 204: Music On Hold Default Playlist .....	320
Figure 205: Play Custom Prompt .....	321
Figure 206: Information Prompt .....	321
Figure 207: Record Custom Prompt .....	322
Figure 208: Fax Settings .....	324
Figure 209: Configure Analog Trunk without Fax Detection .....	326
Figure 210: Configure Extension For Fax Machine .....	327
Figure 211: Configure Extension for Fax Machine: Analog Settings .....	327
Figure 212: Configure Inbound Rule for Fax .....	328
Figure 213: Create Fax Extension .....	328
Figure 214: Inbound Route to Fax Extension .....	329
Figure 215: Fax Sending in Web GUI .....	330
Figure 216: SIP Presence Configuration .....	332
Figure 217: SIP Presence Feature Code .....	333
Figure 218: Presence Status CDR .....	334
Figure 219: Edit Follow Me .....	335
Figure 220: Speed Dial Destinations .....	338
Figure 221: List of Speed Dial .....	338
Figure 222: Create New DISA .....	339
Figure 223: Emergency Number Configuration .....	342
Figure 224: 911 Emergency Sample .....	343
Figure 225: Create New Event List .....	347
Figure 226: Create Dial By Name Group .....	349
Figure 227: Configure Extension First Name and Last Name .....	350
Figure 228: Dial By Name Group In IVR Key Pressing Events .....	351
Figure 229: Dial By Name Group In Inbound Rule .....	352
Figure 230: Status→PBX Status→Active Calls - Ringing .....	354
Figure 231: Status→PBX Status→Active Calls – Call Established .....	354
Figure 232: Call Connection less than half hour .....	355
Figure 233: Call Connection between half an hour and one hour .....	355
Figure 234: Call Connection more than one hour .....	356
Figure 235: Configure to Monitor an Active Call .....	356
Figure 236: Enable/Disable Feature codes .....	363
Figure 237: Parking Lot .....	364
Figure 238: New Parking Lot .....	364
Figure 239 : Monitored call park CID name .....	366
Figure 240: Download Recording File from CDR Page .....	366



Figure 241: Enabling SCA Option under Extension's settings .....	368
Figure 242: SCA Number Configuration .....	368
Figure 243: SCA Private Number Configuration .....	369
Figure 244: SCA Options .....	369
Figure 245: Announcement settings .....	371
Figure 246: Announcement .....	373
Figure 247: SIP Trunk Prompt Tone .....	377
Figure 248: General call Failure Prompts .....	378
Figure 249: Transparent Call-Info .....	388
Figure 250: GDMS Developer Mode Button .....	389
Figure 251: GDMS API Credentials .....	389
Figure 252: GDMS Settings .....	390
Figure 253: UCM on GDMS .....	391
Figure 254: UCM SIP Extensions on GDMS .....	391
Figure 255: CTI Server Listening port .....	396
Figure 256: SugarCRM Basic Settings .....	398
Figure 257: CRM User Settings .....	399
Figure 258: vTigerCRM Basic Settings .....	400
Figure 259: CRM User Settings .....	401
Figure 260: ZohoCRM Basic Settings .....	401
Figure 261: CRM User Settings .....	403
Figure 262: Salesforce Basic Settings .....	403
Figure 263: Salesforce User Settings .....	404
Figure 264: Enabling ACT! CRM .....	405
Figure 265: Enabling CRM on the User Portal .....	405
Figure 266: UCM & PMS interaction .....	407
Figure 267: UCM & HSC PMS interaction .....	408
Figure 268: UCM & Mitel PMS interaction .....	408
Figure 269: Enable PMSAPI .....	409
Figure 270: Create New Room .....	411
Figure 271: Room Status .....	411
Figure 272: Add batch rooms .....	412
Figure 273: Create New Wake Up Service .....	412
Figure 274: Wakeup Call executed .....	413
Figure 275: Create New Mini Bar .....	413
Figure 276: Create New Maid .....	414
Figure 277: Create New Consumer Goods .....	415
Figure 278: Mini Bar .....	415
Figure 279: Create New Wakeup Service – Admin Login .....	416
Figure 280: Create New Wakeup Service – User Portal .....	418
Figure 281: Wakeup Service Feature Code .....	418



Figure 282: Announcements Center .....	419
Figure 283: Announcements Center Group Configuration.....	420
Figure 284: Announcements Center Code Configuration .....	421
Figure 285: Announcements Center example.....	421
Figure 286: QueueMetrics configuration.....	422
Figure 287: Status→PBX Status.....	424
Figure 288: Trunk Status.....	425
Figure 289: Extension Status.....	426
Figure 290: System Status→Storage Usage.....	431
Figure 291: System Status→Resource Usage.....	431
Figure 292: System Events→Alert Events Lists: Disk Usage.....	433
Figure 293: System Events→Alert Events Lists: External Disk Usage.....	433
Figure 294: System Events→Alert Events Lists: Memory Usage.....	434
Figure 295: System Events→Alert Events Lists: System Crash.....	434
Figure 296: System Events→Alert Log.....	435
Figure 297: System Events→Alert Log.....	435
Figure 298: Filter for Alert Log .....	436
Figure 299: CDR Filter .....	438
Figure 300: Call Report.....	440
Figure 301: Call Report Entry with Audio Recording File.....	441
Figure 302: Automatic Download Settings.....	442
Figure 303: CDR Report .....	443
Figure 304: Detailed CDR Information.....	443
Figure 305: Downloaded CDR File Sample.....	443
Figure 306: Downloaded CDR File Sample - Source Channel and Dest Channel 1.....	444
Figure 307: Downloaded CDR File Sample - Source Channel and Dest Channel 2.....	444
Figure 308: CDR Export File data.....	445
Figure 309: CDR Statistics.....	446
Figure 310: CDR→Recording Files.....	447
Figure 311: Edit User Information by Super Admin.....	448
Figure 312: User Portal Login.....	449
Figure 313: User Portal Layout.....	449
Figure 314: User Management Page Display.....	454
Figure 315: Create New User.....	455
Figure 316: User Management – New Users.....	456
Figure 317: Assign Backup permission to "Admin" users.....	457
Figure 318: General User.....	458
Figure 319: Create New Custom Privilege.....	459
Figure 320: Multiple User Operation Error Prompt.....	459
Figure 321: Change Password.....	460
Figure 322: Change Username.....	461



Figure 323: Login Timeout Settings .....	462
Figure 324: Operation Logs .....	463
Figure 325: Operation Logs Filter .....	464
Figure 326: Network Upgrade.....	465
Figure 327: Local Upgrade.....	466
Figure 328: Upgrading Firmware Files.....	466
Figure 329: Reboot UCM6510 .....	467
Figure 330: Create New Backup.....	468
Figure 331: Backup / Restore .....	469
Figure 332: Local Backup .....	470
Figure 333: Data Sync .....	471
Figure 334: Restore UCM6510 from Backup File .....	472
Figure 335: Reset and Reboot.....	473
Figure 336: Cleaner .....	474
Figure 337: USB/SD Card Files Cleanup.....	478
Figure 338: UCM6xxx Recovery Web Page .....	479
Figure 339: Recovery Mode.....	479
Figure 340: Syslog Server.....	480
Figure 341: Ethernet Capture.....	481
Figure 342: PING .....	482
Figure 343: Traceroute.....	482
Figure 344: Troubleshooting Analog Trunks .....	483
Figure 345: A Key Dial-up FXO .....	484
Figure 346: SVIP Record Trace .....	485
Figure 347: E&M Immediate Record Trace.....	485
Figure 348: Service Check.....	486
Figure 349: Network Status.....	486



## DOCUMENT PURPOSE

The intent of this document is to provide device administrators an overview of the specifications and features of the Grandstream UCM6510 IPPBX system. To learn more about the UCM6510, please visit <http://www.grandstream.com/support> to download additional guides.

This guide covers following topics:

- [Product overview](#)
- [Installation](#)
- [Getting started](#)
- [System settings](#)
- [Provisioning](#)
- [Extensions](#)
- [Analog trunks](#)
- [Digital trunks](#)
- [Data trunk](#)
- [VoIP trunks](#)
- [SLA station](#)
- [Call routes](#)
- [Conference](#)
- [Video Conference](#)
- [IVR](#)
- [Voice Prompt](#)
- [Voicemail](#)
- [Ring group](#)
- [Paging and intercom group](#)
- [Call queue](#)
- [Pickup groups](#)
- [Music on hold](#)
- [Fax Server](#)
- [Busy camp-on](#)
- [Presence](#)
- [Follow me](#)
- [Speed Dial](#)
- [DISA](#)
- [Emergency](#)
- [Callback](#)
- [BLF and event list](#)
- [Dial by name](#)
- [Active calls and monitor](#)
- [Call features](#)
- [Call recording](#)
- [CTI Server](#)
- [Asterisk manager interface \(AMI\)](#)
- [CRM integration](#)
- [PMS integration](#)
- [GDMS](#)
- [API](#)
- [QueueMetrics Integration](#)
- [Wakeup service](#)
- [Announcements center](#)
- [Status and reporting](#)
- [CDR \(Call Details Record\)](#)
- [User Portal](#)
- [Upgrading and maintenance](#)
- [Backup/restore](#)
- [High Availability](#)
- [Troubleshooting](#)





## CHANGE LOG

This section documents significant changes from previous versions of the UCM6510 user manual. Only major new features or major document updates are listed here. Minor updates for corrections or editing are not documented here.

### Firmware Version 1.0.20.38

- Added support for FQDN and IP address format in the Realm for Digest Authentication field. [Realm For Digest Authentication]
- Added Enable Record Feature Code option to queue settings. [Enable Record Feature Code]

### Firmware Version 1.0.20.34

- Added the ability to restrict calls between extensions. [RESTRICT CALLS]
- Added the option to select the transport method information displayed in extension information emails in the System Settings→Email Settings→Email Template→Edit Extension Template page. [Email Templates]
- Added configuration options User Information in Fax Header and Fax Header Information to the Call Features Fax/T.38 Fax Settings page. This will give users the option to send a special header in SIP fax messages. [User Information in Fax Header]
- Added command to delete call recordings after downloading them. [Recapi]
- Added DTMF Start Threshold and DTMF End Threshold options to the PBX Settings Interface Settings DAHDI Settings page. [DAHDI Settings]
- Added External Disk Status alert event for monitoring external storage connection status. [External Disk Status]
- The language of column titles in exported CDR reports and statistics reports will now be based on the UCM's display language. [Downloaded CDR File]
- Added 3 more room statuses and corresponding prompts: Room Cleared, Room Not Cleaned, and Room Closed. [Room Status]
- Updated Hmobile Mini Bar request. [HMobile PMS Connector]
- Added the Ringback Tone option for inbound calls. [special ringing tone]
- The value configured in the Server User Agent Value field will now replace the whole User-Agent header value instead of just the "UCM6xxx" part. [Server User Agent]
- Added the ability to import/export a CSV file of the configured DODs for a specified trunk. [DOD Import/Export]

### Firmware Version 1.0.20.31

- Added more details to HA-related syslog. [Syslog]
- To improve UCM flash storage lifespan, syslog will no longer be written to UCM internal storage if a syslog server is configured. [Syslog]



- Added parameters x-gscall-type and x-gs-group-name to the ACK From header sent by the UCM for calls made to ring groups and queues to improve compatibility with non-Grandstream endpoints.
- Added GMT-4:00 (Atlantic Standard Time) and GMT+1:00 (Casablanca) to Time Settings [Time Zone]

### **Firmware Version 1.0.20.28**

- Added HTTPS API commands to list, add, remove, and update analog trunks, SLA trunks, and digital trunks. [HTTPS API]
- Added HTTP/HTTPS protocol option for sending real-time CDR output. [Delivery Method]
- Hidden the option “Allow Guest Calls”.

### **Firmware Version 1.0.20.23**

- No major changes.

### **Firmware Version 1.0.20.22**

No major changes

### **Firmware Version 1.0.20.20**

- Increased the maximum limit of IVR entries to 500 and inbound routes to 5000. [IVR] [Inbound Routes]
- Added support for full compliance with Kari’s law and Ray Baum’s act. [EMERGENCY]
- Increased the maximum number of outbound routes to 500. [Outbound Routes]
- Increased the maximum limit of SIP trunks to 200. [VOIP TRUNKS]

### **Firmware Version 1.0.20.17**

#### **Major Enhancements**

- **[Announcement]**
  - Added Announcement feature. [Announcement]
- **[Backup/Restore]**
  - Added NAS as a backup/restore location. [Backup/Restore]
- **[Conference]**
  - Added conference contact groups. [Contact Group]
  - Added conference call statistics and reports. [Conference Call Statistics]
- **[CRM]**
  - Added support for Zoho CRM v2 API. [ZohoCRM]
- **[GDMS]**
  - Added GDMS SIP account syncing. [GDMS SETTINGS]
- **[HTTPS API]**



- Add a new HTTPS API. [HTTPS API (New)]
- **[Maintenance]**
  - Added the ability to download files on external storage from the USB Disk/SD Card File Management page. [USB Disk/SD Card File Management]
  - Added several more conditions for cleaning files and CDR. [Cleaner]
- **[Queue]**
  - Added the ability to customize the keys used for virtual queue. [Virtual Queue Callback Key Settings]
  - Improved queue statistics page. [Queue Statistics]
  - Added a Welcome Prompt option to the Edit Queue page. [Welcome Prompt]
  - Added QueueMetrics support. [QUEUEMETRICS INTEGRATION]
- **[Paging]**
  - Added Private Intercom paging type (GSC3510 only). [Configure Private Intercom]
- **[PMS]**
  - Added the ability to backup voicemail recordings upon guest check-out. [Connecting to PMS]
- **[Call Routing]**
  - Added Outbound Route CID option to the Extensions/Trunk→Outbound Routes page. [Outbound Route CID]
- **[VoIP Trunks]**
  - Users can now dial into IPVT meeting rooms via peer trunks. [IPVIDEOTALK MEETINGS]
  - Added support for DOD to be assigned to UCM's Fax Sending feature. [Direct Outward Dialing (DOD) via VoIP Trunks]
- **[Zero Config]**
  - Auto Discover can now search for devices located on subnets added to the Subnet Whitelist. [Discovery]

#### Other Enhancements

- **[Active Calls]**
  - Updated Parked calls which will now be displayed in the Active Calls page. [Active Calls Status]
- **[AMI]**
  - AMI username can no longer exceed 64 characters. [ASTERISK MANAGER INTERFACE (RESTRICTED ACCESS)]
- **[Announcement Center]**
  - Announcement Center group name and numbers now have a character limit of 64. [Group Setting]
- **[Basic Calls]**



- Added International Call Prefix. [PBX SETTINGS]
- After an attended transfer is completed, endpoints will now be updated with the CID of the other party instead of keeping the transferor's CID.
- Added Block collect calls option in SIP settings→General settings. [Block Collect Calls]
- **[Backup/Restore]**
  - Added event logs and email notifications for scheduled SFTP backup and data sync results. [Alert Events List]
- **[Call Completion]**
  - Updated the number of CC agents to be limited by the extensions allowed number of concurrent registrations. [CC Mode] [BUSY CAMP-ON]
- **[CDR]**
  - Added Extension Groups as a CDR filter. [Table 149: CDR Filter Criteria]
- **[Conference]**
  - Added a field to configure the Kick Prompt Interval. [Kick Warning Interval]
  - Added support for Conference participant names to be announced when joining/leaving the conference even when the conference is on hold. [Announce Callers]
  - Extended the Meeting duration to be scheduled up to 8 hours. [Meeting Duration]
  - Conference extension number can no longer be used as the conference password if Strong Password is enabled. [Password]
- **[CRM]**
  - Added “Add Unknown Number” option for ACT! CRM. [ACT! CRM]
  - Added <https://www.zohoapis.eu> to the ZohoCRM Server Address dropdown list. [ZohoCRM]
- **[Dial by Name]**
  - Added the ability to upload a custom Dial by Name prompt. [Custom Prompt]
- **[Digital Trunks]**
  - Direct Callback option will be hidden if E&M Immediate or E&M Wink is selected for the Edit T1 Port→Signaling. [Direct Callback]
- **[DOD]**
  - Added DOD names and numbers character limit to 32. [Direct Outward Dialing (DOD) via VoIP Trunks]
- **[Email Settings]**
  - Added new variable `#{CONFR_MEMBERS}`, which shows conference participant details. [Email Templates]
  - Added the following email type filters to the Email Send Log page: Send Fax, Call Queue Statistics, Conference Report. [Email Send Log]
- **[Emergency Calls]**
  - Users can now strip the same amount of numbers as the emergency number length itself. [Strip]

- **[Eventlist]**
  - Added a search bar for eventlists. [Event List]
- **[Extensions]**
  - The Extension and Auth ID fields now support plus signs (+). [Extension][Auth ID]
  - Enable CC option added as batch edit extension option. [Enable CC]
  - Subnet mask can now be specified when configuring subnets that can register to the extension. [ACL Policy] [Local Network Address]
- **[GS Wave Web]**
  - A conference participant's CID number will now be displayed instead of extension number if configured. [Wave WebRTC Video Calling & Conferencing]
  - Improved extension searching when transferring. [Wave WebRTC Video Calling & Conferencing]
  - An error message will now appear when the maximum number of allowed registrations has been reached. [Wave WebRTC Video Calling & Conferencing]
  - Hosts can now generate a link that can be used to invite others to the conference. [Wave WebRTC Video Calling & Conferencing]
- **[IVR]**
  - Added support to upload more than one welcome prompt for IVR. [Welcome Prompt]
- **[LDAP]**
  - Plus signs (+) is now supported when creating contacts and receiving calls with "+" in the CID. [LDAP Phonebook]
  - LDAP Client CA Cert field no longer supports .ca file uploads. The following file types are supported: .crt .der .pem. [LDAP Client CA cert]
  - The Username field will no longer require "cn=" to precede username. [Username]
  - Character limit changed for the following fields:
    - LDAP Server→Root Password: 32 [LDAP Server]
    - LDAP Server→Root DN: 64 [LDAP Server]
    - Phonebook Download Configurations→Username: 64 [Username]
  - LDAP now supports downloading phonebooks from domains. [Server Address]
  - Added space support to the LDAP Client Username. [Username]
- **[Maintenance]**
  - Added Conference Call Statistics Report Cleaner. [Conference Call Statistics Report Cleaner]
- **[OpenVPN®]**
  - Added option Allow Weak SSL Ciphers. [Allow Weak SSL Ciphers]
- **[Paging]**
  - Added an option to allow scheduled paging to play during holidays. [Include Holidays]
  - "=" is no longer supported in the Alert-Info Header field. [Paging/Intercom Group Settings]
- **[Parking]**
  - Ring All Callback on Timeout will not be available if Forward to Destination on Timeout is



- enabled. [Ring All Callback on Timeout]
- The Failover Destination field now has a character limit of 32. [Failover Destination]
- **[PMS]**
  - The Username and Guest Category Code columns in the Room Status page can now be sorted. [Room Status]
- **[Queue]**
  - Agents can now view recordings of their calls in their user portal. [USER PORTAL]
  - A queue can now have 3 chairmen to manage it. [Queue Chairman]
  - Callers can no longer use feature codes in established callbacks. [Enable Feature Codes]
- **[Ring Group]**
  - The character limit of the email address fields for ring group voicemail boxes has been changed from 256 to 128. [Enable Destination]
  - Added the option to skip busy members when receiving an incoming call. [Skip Busy Agent]
- **[SIP Settings]**
  - The TLS Self-signed CA field no longer supports .ca file uploads. The following file types are supported: .ca .crt .der .pem. [TLS Self-Signed CA]
- **[Recording]**
  - MoH will now be recorded when a party is on hold. [Call Recording]
- **[Routing]**
  - Users can now add patterns to the blacklist to restrict calls from several numbers. [Outbound Blacklist]
  - Inbound route imports/exports now have the following columns: Fax Detection, Fax Intelligent Routing, and Fax Destination. [Inbound Route: Import/Export Inbound Route]
  - Users can now export PIN Groups. [Exporting PIN Groups from CSV files]
  - The PIN Groups with Privilege Level option has been added to allow PIN groups to work alongside Privilege Level and Filter on Source Caller ID settings. [PIN Groups with Privilege Level]
- **[System Information]**
  - Added duplex type and network port connection speed information to System Information→Network page. [Speed] [Duplex mode]
- **[Time Settings]**
  - Users can now configure holidays for the next 4 years. [Year]
  - Added time condition Office Time and Out of Holiday. [Time Condition]
  - Default NTP server is now pool.ntp.org. [Remote NTP Server]
- **[User Management]**
  - Added the following custom privileges [Custom Privilege]:
    - CDR Records



- CDR Statistics
- CDR Recordings
- Voice Prompt
- Inbound Routes
- Outbound Routes
- Added the option to change Super Administrator username in the Change Information page. [Change Username]
- Regular users will now be logged out automatically if an admin resets their extension. [USER PORTAL]
- **[Voicemail]**
  - Voicemail group member limit increased from 16 to 27. [Member]
  - The voicemail system will now mention if a voicemail is from a ring group. [Enable Destination]
- **[Voice Prompt]**
  - Voice prompt package upload file size limit increased to 50MB. [Upload Language Package]
  - Custom voice prompt file name character limits for the Voice Prompt and Announcement Center pages have been changed to 100. [Upload Custom Prompt] [ANNOUNCEMENTS CENTER] [Announcement]
- **[VoIP Trunks]**
  - PAI headers now have a character limit of 64 and can only contain alphanumeric characters and/or special characters #\*-\_+. [PAI Header]
  - When editing a register trunk or trunk group and TLS is selected in the Transport field, users can now select between SIP and SIPS URI scheme. [SIP URI Scheme When Using TLS]
  - Domain names can now be sent in the request URL by configuring the From Domain field. [From Domain]
- **[Security]**
  - Added support to specify minimum/maximum TLS version. [TLS Security]

## **Firmware Version 1.0.19.29**

- Updated extension DND response. [General Call Failure Tone]
- The wakeup service prompt now has an option to set a wakeup for the next day. [Wakeup Service using Feature Code]
- Added feature codes for remote management of extension call forwarding. [Remote Call Forward Enable]

## **Firmware Version 1.0.19.27**

- Added new option Email-to-Fax Subject Format [Meeting Duration].
- Added new options Auto Record to automatically record Emergency calls [Auto Record].
- Added Emergency Recordings page to view the records of Emergency calls. [EMERGENCY]
- Increased concurrent registration limit of Grandstream Wave Web to 500 for UCM6510. [Wave]



#### WebRTC Video Calling & Conferencing]

- Added a toggle checkbox to enable/disable Announcement Paging. [Configure Announcement Paging]
- Queue position will now be announced to the caller upon entering the queue [Enable Position Announcement].
- Added new option Enable Hold time Announcement to announce estimated wait times to caller. [Call Center Settings & Enhancements]
- Added a new option “Block the Backward Collect Call” to automatically block collect calls/reverse charge calls.
- Added Chile time zone [Automatic Date and Time]
- Added IPVT Mode option to VoIP Peer Trunk → Advanced Settings page [IPVT Mode].

### **Firmware Version 1.0.19.21**

- Added ACT! CRM support. [ACT! CRM]
- Added Email-to-Fax Blacklist/Whitelist. [Email-to-Fax Blacklist/Whitelist]
- Added digit prepending and stripping support for emergency calls. [EMERGENCY]
- Added new functionalities to Grandstream Wave Web. [Wave WebRTC Video Calling & Conferencing]
- Added LDAPS protocol support. [Technical Specifications] [LDAP Server]
- Added support for .conf and .ovpn files for OpenVPN. [OpenVPN®]
- Added Announcement Paging type. [Configure Announcement Paging]
- Added PMS API as a PMS options. [PMS API]
- Added ability to clear agent call counters. [Reset Agent Call Counter]
- Added Set CallerID option. [Set Caller ID Info]
- Added ability to monitor and change the inbound mode of individual inbound routes and toggle/monitor them via BLF. [Inbound Mode] [Inbound Route: Route-Level Mode] [Inbound Route: Inbound Mode BLF Monitoring]
- Added search functionality to the web portal to quickly find settings. [Web GUI Search Bar]
- Added HT818 model template to Zero Config Models Templates. [PROVISIONING]
- Added the ability to associate differently named OEM models with their original GS models for provisioning purposes. [OEM Models]

### **Firmware Version 1.0.18.13**

- No major changes.

### **Firmware Version 1.0.18.12**

- CDR API configuration page moved from CDR to Value-Added Features.
- Added ability to upload voice prompt files via API.
- Added ability to transfer to custom numbers, not just extensions using Grandstream Wave Web [Wave WebRTC Video Calling & Conferencing]





## Firmware Version 1.0.18.9

- Added new AMI commands. [ASTERISK MANAGER INTERFACE (RESTRICTED ACCESS)]
- Added ability to customize the data columns included in exported CDR reports. [CDR Export Customization]
- Added ability to view a specified extension's membership in Call Queues/Ring Groups and other details. [Extension Details]
- Added GS Wave WebRTC video calling and video conferencing functionality. [Wave WebRTC Video Calling & Conferencing]
- Added ability to disable audio files for Music on Hold. [MUSIC ON HOLD]
- Added Timeout Destination and Ring-All Callback on Timeout options to Parking Lot page. [Parking Lot]
- Added inbound rule importing/exporting functionality. [Inbound Route: Import/Export Inbound Route]

## Firmware Version 1.0.17.16

- Added RTX codec support. [Codec Preference] [Technical Specifications]
- Emergency calls will no longer be logged into CRM servers. [CRM INTEGRATION]
- Added batch extension resetting functionality. [Batch Extension Resetting Functionality]
- Added FAX Resend Support. [Enable Fax Resend][Max Resend Attempts]
- Fail2ban now supports up to 20 whitelist entries. [Fail2Ban Whitelist]
- Added FXO Frequency Tolerance option to Analog Hardware page. [FXO Frequency Tolerance]
- Added NAS support for call recording backup. [NAS]
- Added paging/intercom scheduling functionality. [Configure a Scheduled Paging/Intercom]
- Added Multicast paging support. [PAGING AND INTERCOM GROUP]
- Added Failover Destination under call parking options. [Failover Destination]
- Added Timeout Callback Ringing All options under call parking options. [Ring All Callback on Timeout]
- Added ability to view CID of parked calls on VPKs/MPKs configured as monitored call park. [Monitor Call Park CID Name Information (GXP21xx Phones Only)]
- Added support for endpoint call forwarding under ring group. [Endpoint Call Forwarding Support]
- Added batch operations and searching functionality to the Inbound/Outbound Blacklist pages. Operations include deleting rules and importing/exporting entire blacklists. [Outbound Blacklist][Blacklist][Blacklist Configurations]
- Added ability to monitor and toggle inbound routing modes via BLF. [Inbound Mode BLF Monitoring]
- Added Shared Call Appearance functionality. [Shared Call Appearance]
- Added Forward HOLD Requests option under Misc page. [Forward HOLD Requests]
- Added support for Trunk Groups. [Trunk Groups]
- Added Forward Voicemail to Peered UCMs option. [Forward Voicemail to Peered UCMs]
- Added a new Voicemail Password field under Voicemail settings. [Voicemail Password]
- Added Catalan language support under voice prompt. [VOICE PROMPT]
- Added DOD Name field under VoIP trunk settings. [DOD]
- Changed the default value of Max Wait Time to 60. [Max Wait Time]



- Added “SCA” action type to filtering CDR options. [Action Type]
- Added a prompt asking whether to delete all recording files or not on CDR. [CDR]
- Added a 64-character limit to Conference → Extension field. [Extension]
- Added a 3-character limit to Extension Incrementation field. [Extension Incrementation]
- Added a maximum limit of 500 entries to the IVR blacklist and whitelist. [IVR Black/Whitelist]
- Added character restrictions to LDAP Number Attributes field to ensure correct input. [LDAP Client Configurations]
- Added maximum limit of 99,999 to parking timeout. [Parking Timeout]
- Added a 63-character limit to the Room Number field. [Room Number]
- Editing an already executed wakeup service will automatically change the service’s status to “Programmed”. [Action Status]
- Adding UCM disconnection when an SSH client changes the password for the connected user.
- LCD display will show “Recovery Mode” instead of “No Provision” when the UCM is in recovery mode. [System Recovery]
- Capture files saved on external devices will have “capture” prepended to file names. [Ethernet Capture]
- Added dashes and + characters to Fax, Home Number, and Mobile Phone Number fields.
- Updated external number to accept only letters, numbers and special characters. [External Number]
- Added a 64-character limit to Custom Presence Status field. [Custom Presence Status]
- Increased the character limit for the provider name field to 64 characters. [Provider Name]
- Updated From Domain field to accept special characters. [From Domain]
- Username Prompt filename character limit changed to 18. [Username Prompt Customization]
- Increased the character limit for the wakeup service name field to 64 characters. [WAKEUP SERVICE]
- Users can now upload custom prompts directly to pages without having to get redirected to the Voice Prompt→Custom Prompt page. [Custom Prompt]
- Added character restrictions to device firmware file names. [firmware file name]
- Added Email-to-Fax support. [Enable Email-to-Fax]

### **Firmware Version 1.0.16.20**

- Added an option to enable/disable remote voicemail access function. [Voicemail Remote Access]

### **Firmware Version 1.0.16.18**

- Added support for emergency calls. [EMERGENCY]
- Added support for vTigerCRM. [vTigerCRM]
- Added support for ZohoCRM. [ZohoCRM]
- Added support for HSC PMS. [HSC PMS]
- Added support for Direct Callback. [Direct Callback] [Direct Callback] [Direct Callback]
- Added option to enable/disable call waiting under extension level. [Enable Call Waiting]
- Added option to passthrough SIP PAI Header. [Passthrough PAI Header]
- Added option to copy device settings in zero config. [Managing discovered devices]
- Added support for call failure prompts customization. [General Call Failure Tone]



- Added option to download automatically HTTP server certificate. [Certificate Options]
- Added support to include more menus on user custom privilege. [Custom Privilege]
- Added possibility to delete CDR records based on search result. [CDR]
- Added option to send caller to specific destination when queue is empty. [CALL QUEUE]
- Added XML file type support for importing phonebooks. [LDAP Server][LDAP Phonebook]
- Added ability to customize the LDAP name and number attributes in the Phonebook Download Configurations page [LDAP Client Configurations]
- Added option to download Call Queue Statistics. [Queue Statistics]
- Added option to choose DNS mode during calls. [DNS mode]
- Added ability to batch add devices by importing a CSV file. [PROVISIONING]
- Added ability to divide a parking lot extension into multiple lots [Parking Lot]
- Added option to reset extension settings. [Reset single extension]

### **Firmware Version 1.0.15.16**

- Added High Availability support. [HIGH AVAILABILITY]
- Added ability to upgrade HA device. [Upgrading HA100]
- Add support to announce name in Dial By Name feature. [Dial By Name]
- Increased maximum number of call queue static agents. [Static Agents limitation]
- Added operation logs details and remarks. [Login Settings  
Change Password]
- Added extension level voicemail-to-Email setting. [Send Voicemail to Email] [Keep Voicemail after Emailing]
- Added support for reset certificate.
- Added support for GXP21xx color phone queue login/logout softkey. [Enable Agent Login]
- Added support to add comments to inbound/outbound route patterns. [Pattern] [Pattern]
- Added support to import PIN groups from CSV files. [Importing PIN Groups from CSV files]
- Added support for wakeup groups. [WAKEUP SERVICE]
- Added support for SYN Flood defense. [SYN-Flood Defense Enable]
- Improved Voice Message Responses for failed SIP trunk calls. [voice message responses]
- Added Queue Log option to backup/restore page. [Backup/Restore]
- Modified Switchboard UI to offer easier access to call options. [Switchboard]
- Further optimized Call Queue Statistics page to provide a more user-friendly experience and improve performance. [Queue Statistics]
- Added image uploading support to email templates. [Email Templates]
- Added IPv6 gateway support. [Static Routes]
- Added Fail2Ban to support TCP/TLS beside the already-supported UDP. [Fail2ban]
- Added PPI mode option under SIP trunk advanced settings. [PPI Mode]
- Added IP address whitelist to web GUI configuration. [Enable IP Whitelist]
- Restored ability to sort the ringing order of Follow Me numbers. [FOLLOW ME]
- Added CDR records separation [CDR separation]



### **Firmware Version 1.0.14.24**

- Added protection to prevent HTTP rogue login.

### **Firmware Version 1.0.14.23**

- Restored ability to view voicemail count in the Extension/Trunk overview
- Restored the ability to set custom numbers for call forwarding settings. [Call Forward Unconditional] [Call Forward No Answer] [Call Forward Busy]
- Restored previous format for entering multiple dial plans (one pattern per line) for inbound/outbound rules. [Pattern] [Pattern]
- Restored Zero Config's sorting by column and introduced a search bar. [Managing discovered devices]

### **Firmware Version 1.0.14.21**

- Implementing a new Web GUI consistent operating style which can display and update the system's status in real time.
- Added support for SIP Presence. [PRESENCE]
- Added support for Call Center feature/ Virtual Call Queue. [Call Center Settings & Enhancements]
- Added support for Call Queue position announcement. [Call Center Settings & Enhancements]
- Added support for Call Queue Statistics. [Queue Statistics]
- Added support for Call Queue Autofill. [Queue Auto fill enhancement]
- Added switchboard for call queue monitoring. [Switchboard]
- Added ability to restore blind transfer call to transferrer. [Allow callback when blind transfer fails]
- Added support for external disk cleaner. [USB/SD cleaner]
- Added option to enable DOD when call is being diverted/forwarded. [Use callee DOD on FWD or Ring Simultaneously]
- Change follow me settings to extension level settings. [FOLLOW ME]
- Added support for call forward whitelist. [FWD Whitelist]
- Added Fail2Ban defense from web login attack. [Login Attack Defense]
- Added limitation for maximum number of call queue static agents. [Static Agents limitation]
- Added support for wakeup service module in Custom privilege. [Custom Privilege]
- Added IPv6 support for T.38.
- Added DAHDI settings. [DAHDI Settings]
- Added ability to pass through SIP Call-Info header to support GXP phone JPEG\_Over\_HTTP with encryption and authentication to open door for GDS3710. [Transparent Call-Info header]

### **Firmware Version 1.0.13.14**

- Added extension whitelist/blacklist for IVR dialing. [IVR]
- Added ability to include DOD in PPI Header for SIP trunk. [PPI Mode]



- Added ability to customize PAI Header. [PAI Header]
- Added blacklist for outbound calls. [Outbound Blacklist]
- Added support to upload/download MOH package from Web GUI. [MUSIC ON HOLD]
- Added support to download custom prompts from Web GUI. [Download All Custom Prompt]
- Added option to configure prompt timeout in Dial By Name. [DIAL BY NAME]
- Added description field in ZeroConfig settings to configure Softkey/Line/MPK for GXP series phones. [PROVISIONING]
- Improved seamless transfer privilege control. [Seamless transfer privilege control]
- Added RTP Keep-alive support. [RTP Keep-alive]
- Added Email Send Log. [Email Send Log]
- Added support for Mitel simulation/protocol interfaces for PMS module. [PMS INTEGRATION]
- Added support for up to 10 failover trunks. [Use Failover Trunk]

### **Firmware Version 1.0.12.19**

- Added support for binding a mobile phone number to extension. [Mobile Phone Number]
- Added support OPUS codec.
- Added support call-barging privilege settings based on extensions. [Monitor privilege control]
- Added support for Seamless Transfer. [Enable Seamless Transfer]
- Added support for Custom Call-Info for Auto Answer. [Custom Call-info for Auto Answer]
- Added support for DND Whitelist. [Do Not Disturb]
- Added Field Description on Softkey, Line keys and MPK from Zero Config.
- Added support to select interval for numbers on Batch add extension. [Extension Incrementation]
- Added support for Batch Add CallerID Number. [CallerID Number]
- Added support for Search Extensions Using CallerID Name.
- Added support to Enable/Disable Inbound and Outbound Route [Disable This Route / Disable This Route]
- Added support for Outbound Route Time Condition. [Time Condition]
- Added support for IPv6. [IPv6 Address]
- Added support for MTU configurable. [MTU]
- Added support of CRM. [CRM]
- Added support for Custom Privilege in User Management. [Custom Privilege]
- Added Hotline support for FXS Extension. [Hotline]
- Added support for Separate Wakeup Service. [WAKEUP SERVICE]
- Added ability to provision phones from different network subnets using zero config. [Subnet Whitelist]
- One-key-dial is replaced by Speed Dial to support more than one digit. [SPEED DIAL]
- Added append extension number in the end of DOD. [DOD]
- Support Japan CID NTT Detect.
- Added support for Ethernet Capture Auto Sync to SFTP Server. [Enable SFTP Data Sync]
- Added support for Ethernet Capture saved to External Storage Device. [Ethernet Capture]
- Added support for Disable Extension Range on the Setup Wizard. [Setup Wizard]
- Added more support for Port Forwarding. [Port Forwarding]



- Added support for USB/SD Card Files Cleanup. [USB Disk/SD Card File Management]
- Added support for A Key Dial-up FXO. [PBX Settings/RTP Settings]
- Added support for ACIM Detect Option for FXO. [DAHDI and Analog Hardware Configuration]
- Added support for some special character on the file name of FW. [Upgrading via Local Upload]
- Added more search criteria of CDR. [CDR]
- Added support of "Allow outgoing calls if registration failure" for register trunks. [Allow outgoing calls if registration failure]
- Added support for music on hold playback from webGUI. [MUSIC ON HOLD]
- Added support to enable delete recording files for user privilege. [Consumer]
- Added support disk Inode usage in "Storage Usage" page. [Storage Usage]
- Added support for Ring Group/Call Queue/IVR Display Option for Caller ID. [Replace Caller ID | Replace | Replace Display Name]
- Added support to Detect talking users in conference. [CONFERENCE]
- Added support of Mini Bar for PMS. [Mini Bar]

### **Firmware Version 1.0.11.27**

- Added ability to sort extension status on Web GUI.
- Added one click enable / disable feature code. [Feature Codes]
- Added Uruguay time zone support. [Automatic Date and Time]
- Added distinctive ring tone support. [Configure Call Queue] [Configure IVR] [Create New SIP Extension]
- Added special character support for SFTP client account. [Data Sync]
- Added destination directory support for data sync. [Data Sync]
- Added ring group music on hold. [Configure Ring Group]
- Added CDR multi-email / time condition support. [CDR]
- Added blacklist anonymous call block. [Blacklist][Blacklist Configurations]
- Added ability to sort selected extension in Eventlist. [Event List]
- Added banned user list for Web GUI login attempts. [Login S]
- Added Email template support. [Email Templates]
- Added outbound route country restriction.
- Added external disk usage alert option. [Alert Events List]
- Added range IP input support for dynamic defense white list. [Dynamic Defense]
- Added blacklist support for Fail2ban. [Fail2ban]
- Added ability to reboot device from zero config page. [Discovery]
- Added GXP1628B template for zero config. [Model Update]
- Added PIN group support. [PIN Groups]
- Added PMS support. [PMS INTEGRATION]
- Added call queue custom prompt support. [Configure Call Queue]
- Added call queue retry time support. [Configure Call Queue]
- Added support for DHCP Client List. [DHCP Client List]



## Firmware Version 1.0.10.44

- Added Zero Config DP750 support. [Model Templates]
- Added Configure framing with “esf” or “d4” in T1/J1. [Digital Hardware Configuration Parameters]

## Firmware Version 1.0.10.39

- Added multiple modes support for inbound route. [Inbound Route: Multiple Mode]
- Added option “Enable Inbound Multiple Mode”, “Inbound Default Mode” and “Inbound Mode 1” for switching inbound route mode via feature code. [Feature Codes]
- Added prepending prefix for inbound route. [Inbound Route: Prepend Example]
- Added multiple registration per extension. [Multiple Registrations per Extension]
- Added SIP Message support. [SMS Message Support]
- Added 100rel option for 100rel support. [SIP Settings/TOS]
- Added video preview support. [PBX Settings/RTP Settings]
- Added User Portal Page Fax sending support.
- Added Fax intelligent routing.
- Added Re-Invite with two media (audio, image) support for fax sending. [Fax with Two Media]
- Added option “Max Concurrent Sending Fax” in Fax settings. [Configure Fax/T.38]
- Added option “Fax Queue Length” in Fax settings. [Configure Fax/T.38]
- Added Google Service Setting Support. [Google Service Settings Support]
- Added Conference Schedule. [Conference Schedule]
- Added Setup Wizard. [Setup Wizard]
- Added ability to customize specific prompt. [Upload Language Package]
- Added option “ALL” when making backup file. [Backup/Restore]
- Added “Enable Destination” and “Default Destination” in Follow Me settings. [FOLLOW ME]
- Added “Call Duration Limit” option in Web GUI→PBX→Internal Options→General. [General]
- Added “Enable Auto E-mail Notification” option in Web GUI→PBX→Internal Options→General. [General]
- Added options “ICE Support” and “STUN Server” in Web GUI→PBX→Internal Options→RTP Settings. [PBX Settings/RTP Settings]
- Added payload type setting for VP8 in Web GUI→PBX→Internal Options→Payload. [Payload]
- Added options “External Host” and “Use IP address in SDP” in Web GUI→PBX→SIP Settings→NAT. [SIP Settings/NAT]
- Improved CDR. [CDR Improvement]
- Added Network Status page under web GUI System Status→Network Status. [Network Status]

## Firmware Version 1.0.2.7

- Added PRI T310 configuration. [Digital Hardware Configuration]
- Added Announcement Center. [ANNOUNCEMENTS CENTER]





## Firmware Version 1.0.2.5

- Added option to enable/disable SSH access via LCD or Web GUI. [TLS Security][SSH Access]
- Added ability to select voicemail storage (Email + WAV is supported). [Voicemail Email Settings]
- Added support to allow remote peer extensions in ring group. [Remote Extension in Ring Group]
- Added ability to strip and prepend digits in inbound routes. [Inbound Rule Configurations]
- Added ability to search extensions on Extension page.
- Added user portal for users to log in with extension number, access user information, extension configuration and CDR. [USER PORTAL]
- Added support to send Fax via Web GUI. [Fax Sending]
- Added “Enable LDAP” option to skip the extension from UCM default LDAP phonebook. [Voicemail Email Settings]
- Added video RE-INVITE support.
- Added DDNS Support. [DDNS Settings]
- Added ability to search the CDR by called number. [CDR]
- Added ability to select the file types for automatic backup. [Backup/Restore]
- Added automatic backup support on SD Card or USB storage. [Backup/Restore]
- Added support to skip trunk authentication by time condition.
- Added option to send P-Asserted-Identity header in SIP Register Trunk. [VOIP TRUNKS]
- Added ability to specify trunks in CDR filters. [CDR]
- Added ability to use Pattern in Caller Number to filter CDR. [CDR]
- Added support to send UNREGISTER when VoIP trunk is disabled. [VOIP TRUNKS]
- Added LDAP client support. [LDAP Client Configurations]
- Added option to specify the chronological order to voice mails. [VOICEMAIL]
- Added option to configure whether to skip pressing 1/2 to accept or reject calls from Follow Me [FOLLOW ME]
- Added option to specify port range in Port Forwarding configuration. [Port Forwarding]
- Added ability to go back to IVR menu from Dial By Name by pressing the star key. [Dial By Name Configuration]
- Added ability to filter alert logs. [Alert Log]
- Added ability to delete alert logs. [Alert Log]
- Added NAT option for peer trunk. [VOIP TRUNKS]
- Improved Automatic Download CDR result format. [CDR]
- Fixed Digital Trunk SS7 signaling mode inbound / outbound call problem.
- Fixed Asterisk is crashed while using external MCB and CEI.

## Firmware Version 1.0.1.12

- Added Active Calls feature to monitor call status and barge in active calls.
- Added support to disable the trunk for VoIP trunk and analog trunk. [VOIP TRUNKS] [ANALOG TRUNKS]
- Added RBS support on T1.





- Added Frame Relay support on Data Trunk. [DATA TRUNK]
- Added 'Assign CIC to D-channel' option on SS7 settings page. [DIGITAL TRUNKS]
- Added 'First CIC' option in SS7 configuration. [DIGITAL TRUNKS]
- Added 'D-Chan' selection for PRI and SS7 in editing digital ports. [DIGITAL TRUNKS]
- Added support for Ring simultaneously feature for extensions. [EXTENSIONS]
- Added support for Music On Hold selection per extension. [EXTENSIONS]
- Added support to disable this extension per extension. [EXTENSIONS]
- Added ability to set personal password for making outbound calls per extension. [EXTENSIONS]
- Added 'TEL URI' configuration for SIP extension/VoIP trunk. [EXTENSIONS] [VOIP TRUNKS]
- Added E&M Immediate and E&M Wink signaling for T1. [DIGITAL TRUNKS]
- Renamed the 'network backup' settings items to 'data sync'. [Data Sync]
- Added "Download Search Result" in CDR. [CDR]
- Added office time and holiday setting support. [Office Time] [Holiday]
- Added time condition for call forward. [EXTENSIONS]
- Added support to monitor FXO trunk using SLA. [SLA STATION]
- Added One-Key Dial function.
- Added Follow Me support. [FOLLOW ME]
- Supported external number as the key pressing event of an IVR.
- Improved APIs for Zero Config templates and settings. [PROVISIONING]
- Added advanced settings for devices discovered in Zero Config. [Device Configuration]
- Added ability to delete multiple recording files at one time. [Recording Files]
- Added call queue destination if no answer/timeout. [CALL QUEUE]
- Added call queue Music on Hold customization. [CALL QUEUE]
- Added restricted AMI access. [AMI]
- Added ability to choose the type(s) of files to be cleaned in cleaner.
- Added DTMF configuration per SIP trunk. [VOIP TRUNKS]
- Added ability to upload and play ring group announcement. [RING GROUP]
- Added ability to upload and play paging call announcement. [PAGING AND INTERCOM GROUP]
- Added Alert-info configuration for distinctive ringing on inbound route. [Inbound Routes]
- Added ability to prepend digits/trunk name to inbound calls' caller ID. [Inbound Routes]
- Modified Static Routes Interface display when network method is changed. [Static Routes]

## **Firmware Version 1.0.0.25**

- This is the initial version.



## WELCOME

Thank you for purchasing Grandstream UCM6510 IP PBX appliance. The UCM6510 is an innovative IP PBX appliance for E1/T1/J1 networks that brings enterprise-grade unified communications and security protection to enterprises, small-to-medium businesses (SMBs), retail environments and residential settings in an easy-to-manage fashion. Powered by an advanced hardware platform and revolutionary software functionalities, the UCM6510 offers a breakthrough turnkey solution for converged voice, video, data, fax, security surveillance, and mobility applications out of the box without any extra license fees or recurring costs.

---

 **Caution:**

Changes or modifications to this product not expressly approved by Grandstream, or operation of this product in any way other than as detailed by this User Manual, could void your manufacturer warranty.

 **Warning:**

Please do not use a different power adapter with the UCM6510 as it may cause damage to the product and void the manufacturer warranty.

---

This document is subject to change without notice. The latest electronic version of this user manual is available for download here:

<http://www.grandstream.com/support>

Reproduction or transmittal of the entire or any part, in any form or by any means, electronic or print, for any purpose without the express written permission of Grandstream Networks, Inc. is not allowed.



## PRODUCT OVERVIEW

### Feature Highlights

- 1 GHz quad-core ARM Cortex-A9 processor, 1GB DDR3 RAM, 32GB flash storage, and dedicated high performance multi-core DSP array for advanced voice processing.
- 1 integrated E1/T1/J1 interface, 2 FXO ports, and 2 FXS ports with lifeline capability in case of power outage.
- Hardware DSP-based carrier-grade line echo cancellation (LEC) with 128ms-tail-length, hardware-based caller ID/call progress tone, and automatic impedance matching for various countries.
- Gigabit network ports with the LAN port supporting PoE, USB 2.0 port, SD card slot, and an integrated NAT router with advanced QoS support.
- Several protective measures against malicious attacks: Fail2Ban, whitelisting, blacklisting, alerts, etc.
- Data and data-voice communication via E1/T1/J1 with SS7/PRI.
- Supports up to 2000 SIP endpoint registrations, 200 concurrent calls (132 SRTP encrypted concurrent calls), and 64 conference participants.
- Offers flexible dial plans, call routing, site peering, and call recordings (manual/automatic for SIP calls).
- Functions as a central control panel for endpoints, integrated NTP server, and integrated LDAP contact directory.
- Automated detection and provisioning of supported IP phones, video phones, ATAs, gateways, SIP cameras, and others for simple and quick deployment
- Secure encryption with SRTP, TLS, and HTTPS with hardware encryption accelerator.
- Power redundancy and high availability via hot standby clustering.
- Scheduled backups and file cleaning for convenient maintenance.

### Technical Specifications

**Table 1: Technical Specifications**

Interfaces	
<b>Analog Telephone FXS Ports</b>	2x RJ11 ports with lifeline support Each port supports 2 REN
<b>PSTN Line FXO Ports</b>	2x RJ11 ports (with lifeline support)
<b>T1/E1/J1 Interface</b>	1x RJ45 port
<b>Network Interfaces</b>	1x Gigabit WAN port 1x Gigabit LAN port with PoE support 1x Gigabit port for Hot-Standby Clustering redundancy
<b>NAT Router</b>	Yes



<b>Peripheral Ports</b>	USB 2.0, SD
<b>LED Indicators</b>	Power 1/2, PoE, USB, SD, T1/E1/J1, FXS 1/2, FXO 1/2, LAN, WAN, Heartbeat
<b>LCD Display</b>	128x32 dot matrix graphic LCD with DOWN and OK buttons
<b>Reset Switch</b>	Yes, long press for factory reset and short press for reboot
<b>Voice/Video Capabilities</b>	
<b>Voice-over-Packet Capabilities</b>	128ms tail-length carrier-grade Line Echo Cancellation with NLP Packetized Voice Protocol Unit, dynamic jitter buffer, modem detection, and auto-switch to G.711.
<b>Voice and Fax Codecs</b>	G.711 A-law/U-law, G.722, G.723.1 5.3K/6.3K, G.726, G.729A/B, OPUS, iLBC, GSM, RTX, AAL2-G.726-32, ADPCM; T.38
<b>Video Codecs</b>	H.264, H.263, H.263+, H.265
<b>QoS</b>	Layer 3 QoS, Layer 2 QoS
<b>Signaling and Control</b>	
<b>DTMF Methods</b>	Inband, RFC4733, and SIP INFO
<b>Digital Signaling</b>	PRI, SS7, MFC/R2, E&M
<b>Provisioning Protocol and Plug-and-Play</b>	TFTP/HTTP/HTTPS, auto-discovery & auto-provisioning of Grandstream IP endpoints via ZeroConfig (DHCP Option 66/multicast SIP SUBSCRIBE/mDNS), Eventlist between local and remote trunks
<b>Network Protocols</b>	TCP/UDP/IP, RTP/RTCP, ICMP, ARP, DNS, DDNS, DHCP, NTP, TFTP, SSH, HTTP/HTTPS, PPPoE, SIP (RFC3261), STUN, SRTP, TLS, LDAP/LDAPS, HDLC, HDLC-ETH, PPP, Frame Relay
<b>Disconnect Methods</b>	Call Progress Tone, Polarity Reversal, Hook Flash Timing, Loop Current Disconnect, Busy Tone
<b>Security</b>	
<b>Media</b>	SRTP, TLS 1.2, HTTPS, SSH
<b>Advanced Defense</b>	Fail2ban, alert events, whitelist, blacklist, strong password requirement.
<b>Physical</b>	
<b>Universal Power Supply</b>	Input: 100-240VAC, 50-60Hz; Output: DC+12VDC, 1.5A
<b>Physical</b>	Unit Weight: 2.165 Kg; Package weight: 3.012 Kg
<b>Dimensions</b>	440mm (L) x 185mm (W) x 44mm (H)



<b>Environmental</b>	Operating: 32 – 113°F / 0 – 45°C, Humidity 10-90% (non-condensing) Storage: 14 – 140°F / -10 – 60°C, Humidity 10-90% (non-condensing)
<b>Mounting</b>	Rack mount
<b>Additional Features</b>	
<b>Multi-language Support</b>	English, Simplified Chinese, Traditional Chinese, Spanish, French, Portuguese, German, Russian, Italian, Polish, Czech for Web GUI; Customizable IVR/voice prompts for English, Chinese, British English, German, Spanish, Greek, French, Italian, Dutch, Polish, Portuguese, Russian, Swedish, Turkish, Hebrew and Arabic
<b>Caller ID</b>	Bellcore/Telcordia, ETSI-FSK, ETSI-DTMF, SIN 227 – BT, NTT Japan
<b>Polarity Reversal/ Wink</b>	Yes, with enable/disable option upon call establishment and termination
<b>Call Center</b>	Multiple configurable call queues, automatic call distribution (ACD) based on agent skills/availability/busy level, in-queue announcement
<b>Customizable Auto Attendant</b>	Up to 5 layers of IVR (Interactive Voice Response)
<b>Maximum Call Capacity</b>	Up to 2000 registered SIP endpoints, up to 200 concurrent calls
<b>Conference rooms</b>	Up to 8 bridges, up to 64 simultaneous conference attendees
<b>Call Features</b>	Call park, call forward, call transfer, DND, DISA, ring group, pickup group, blacklist, paging/intercom and etc.
<b>Compliance</b>	<ul style="list-style-type: none"> <li>• FCC: Part 15 (CFR 47) Playlist B, Part 68</li> <li>• CE: EN55022 Playlist B, EN55024, EN61000-3-2, EN61000-3-3, EN60950-1, TBR21, RoHS</li> <li>• A-TICK: AS/NZS CISPR 22 Playlist B, AS/NZS CISPR 24, AS/NZS 60950, AS/ACIF S002</li> <li>• ITU-T K.21 (Basic Level); UL 60950 (power adapter)</li> <li>• T1: TIA-968-B Section 5.2.4</li> <li>• E1: TBR12/TBR13, E1: AS/ACIF</li> </ul>



## INSTALLATION

Before deploying and configuring the UCM6510 series, the device needs to be properly powered up and connected to a network. This section describes detailed information on installation, connection and warranty policy of the UCM6510 series.

### Equipment Packaging

Table 2: UCM6510 Equipment Packaging

<b>UCM6510 Main Case</b>	1x
<b>Power Adapter</b>	2x
<b>Ethernet Cable</b>	1x
<b>Rack Mounts</b>	2x
<b>Screws</b>	8x
<b>Quick Installation Guide</b>	1x

### Connect your UCM6510

The following screenshots illustrate the front and back panels of the UCM6510:

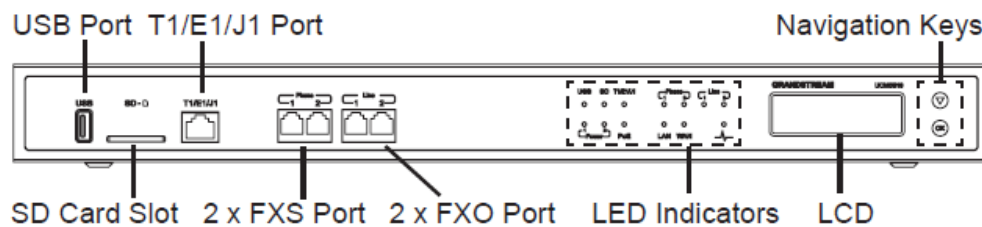


Figure 1: UCM6510 Front View

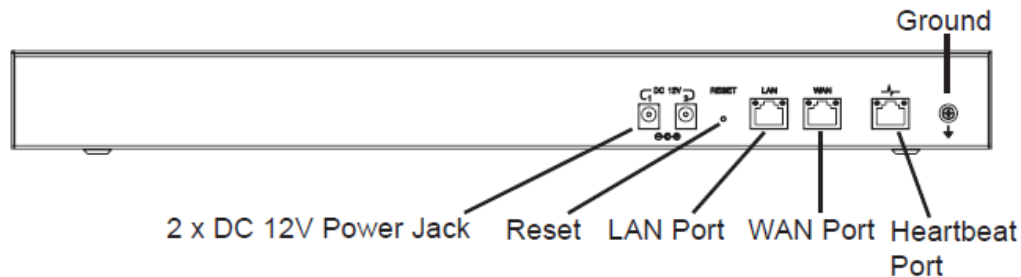


Figure 2: UCM6510 Back View

Follow the following steps to connect the UCM6510 for initial setup:

1. Connect one end of an RJ-45 Ethernet cable (cable type: straight through) into the WAN port of the UCM6510; connect the other end into the uplink port of an Ethernet switch/hub.
2. Connect the 12V DC power adapter into one of the power jacks located on the back of the UCM6510. It is highly recommended to connect the other end of the plug to a surge protected power outlet. For power redundancy, connect a second 12V DC power adapter into the other power jack.
3. Wait for the UCM6510 to boot up. The LCD in the front will show its hardware information when the bootup process is done.
4. Once the UCM6510 is successfully connected to the network, the LED indicator for the WAN port in the front will be solid green, and the LCD will display the IP address.

**Note:** The ground screw needs to be connected.

Follow the steps below based on your environment:

1. PSTN Line Connection: connect RJ11 cables from the wall jack to the UCM6510's LINE ports (FXO ports).
2. Analog Line Connection: connect RJ11 cables from phones or fax machines to the UCM6510's PHONE ports (FXS ports).
3. T1/E1/J1 Line Connection: connect one end of the E1/T1/J1 cable into the UCM's E1/T1/J1 port. Connect the other end to the appropriate port on legacy PBX systems. E1/T1/J1 crossover cables are not included in the UCM6510 packaging. Please see the following figure illustrating the crossover cable pin-out.:

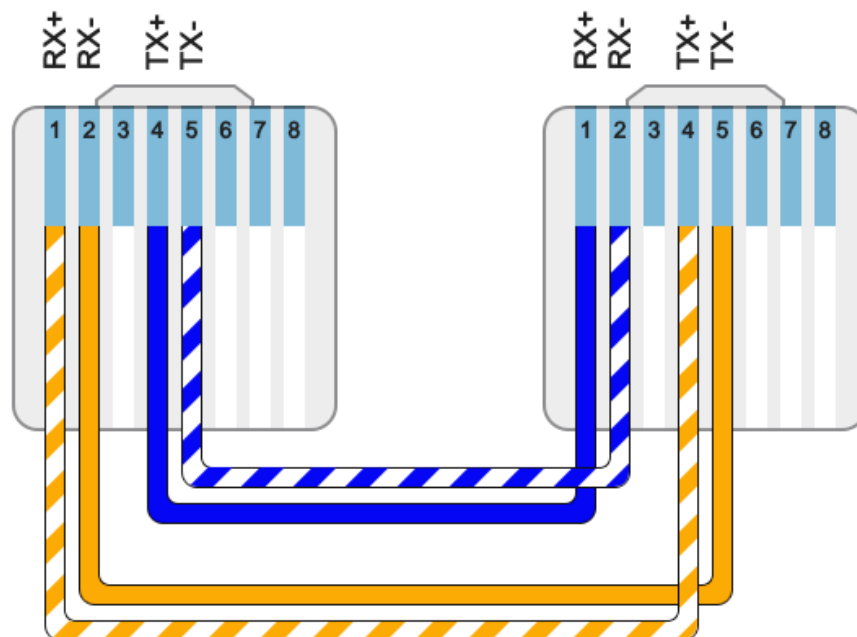


Figure 3: UCM6510 T1/E1/J1 Crossover Cable Pin-out

## Safety Compliances

The UCM6510 series IP PBX complies with FCC/CE and various safety standards. The UCM6510 power adapter is compliant with the UL standard. Use the universal power adapter provided with the UCM6510 package only. The manufacturer's warranty does not cover damages to the device caused by unsupported power adapters.

## Warranty

If the UCM6510 series IP PBX was purchased from a reseller, please contact the company where the device was purchased for replacement, repair or refund. If the device was purchased directly from Grandstream Networks, contact our Technical Support Team for an RMA (Return Materials Authorization) number before the product is returned. Grandstream Networks reserves the right to remedy warranty policy without prior notification.

---

 **Warning:**

Use the power adapter provided with the UCM6510 series IP PBX. Do not use a different power adapter as this may damage the device. This type of damage is not covered under warranty.

---



## GETTING STARTED

To get started with the UCM6510 setup process, use the following available interfaces: LCD display, LED indicators, and web portal.

- The LCD display shows hardware, software, and network information and can be navigated via the DOWN and OK buttons next to the display. From here, users can configure basic network settings, run diagnostic tests, and factory reset.
- The LED indicators at the front of the device provides interface connection and activity status.
- The web portal (may also be referred to as web UI in this guide) is the primary method of configuring the UCM.

This section will provide step-by-step instructions on how to use these interfaces to quickly set up the UCM and start making and receiving calls with it.

### Use The LCD Menu

- **Idle Screen**  
Once the device has booted up completely, the LCD will show the UCM model, hardware version (e.g., V1.4A), and IP address. Upon menu key press timeout (15 seconds), the screen will default back to this information. Pressing the DOWN button will show the system time.
- **Menu**  
Pressing the OK button will show the main menu. All available menu options are found in [Table 3: LCD Menu Options].
- **Menu Navigation**  
Pressing the DOWN button will scroll through the menu options. Press the OK button to select an option.
- **Exit**  
Selecting the Back option will return to the previous menu. For the Device Info, Network Info, and Web Info screens that have no Back option, pressing the OK button will return to the previous menu.
- **LCD Backlight**  
The LCD backlight will turn on upon button press and will go off when idle for 30 seconds.



The following table shows the LCD menu options.

**Table 3: LCD Menu Options**

<b>View Events</b>	<ul style="list-style-type: none"> <li>• <b>Critical Events</b></li> <li>• <b>Other Events</b></li> </ul>
<b>Device Info</b>	<ul style="list-style-type: none"> <li>• <b>Hardware:</b> Hardware version number</li> <li>• <b>Software:</b> Software version number</li> <li>• <b>P/N:</b> Part number</li> <li>• <b>WAN MAC:</b> WAN side MAC address</li> <li>• <b>LAN MAC:</b> LAN side MAC address</li> <li>• <b>Uptime:</b> System uptime since the last reboot</li> </ul>
<b>Network Info</b>	<ul style="list-style-type: none"> <li>• <b>WAN Mode:</b> DHCP, Static IP, or PPPoE</li> <li>• <b>WAN IP:</b> IP address</li> <li>• <b>WAN Subnet Mask</b></li> <li>• <b>LAN IP:</b> IP address</li> <li>• <b>LAN Subnet Mask</b></li> </ul>
<b>Network Menu</b>	<ul style="list-style-type: none"> <li>• <b>WAN Mode:</b> Select WAN mode as DHCP, Static IP or PPPoE</li> <li>• <b>Static Routes Reset:</b> Select this to reset static route settings.</li> </ul>
<b>Factory Menu</b>	<ul style="list-style-type: none"> <li>• <b>Reboot</b></li> <li>• <b>Factory Reset</b></li> <li>• <b>LCD Test Patterns</b> Press DOWN and OK buttons to scroll through and select different LCD patterns to test. Once a test is done, press the OK button to return to the previous menu.</li> <li>• <b>Fan Mode</b> Select Auto or On.</li> <li>• <b>LED Test Patterns</b> All On, All Off, and Blinking are the available options. Selecting Back in the menu will revert the LED indicators back to their actual status.</li> <li>• <b>RTC Test Patterns</b> Select either 2022-02-22 22:22 or 2011-01-11 11:11 to start the RTC (Real-Time Clock) test pattern. Check the system time from either the LCD idle screen or in the web portal System Status-&gt;System Information-&gt;General page. To revert back to the correct time, manually reboot the device.</li> </ul>



	<ul style="list-style-type: none"> <li>• <b>Hardware Testing</b> Select Test SVIP to verify hardware connections within the device. The result will display on the LCD when the test is complete.</li> </ul>
<b>Web Info</b>	<ul style="list-style-type: none"> <li>• <b>Protocol:</b> Web access protocol (HTTP/ HTTPS). HTTPS is used by default.</li> <li>• <b>Port:</b> Web access port number, which is 8089 by default.</li> </ul>
<b>SSH Switch</b>	<ul style="list-style-type: none"> <li>• <b>Enable SSH</b></li> <li>• <b>Disable SSH</b></li> </ul> SSH access is disabled by default

## Use The LED Indicators

The UCM6510 has LED indicators in the front to display connection status. The following table shows the status definitions.

**Table 4: UCM6510 LED Indicators**

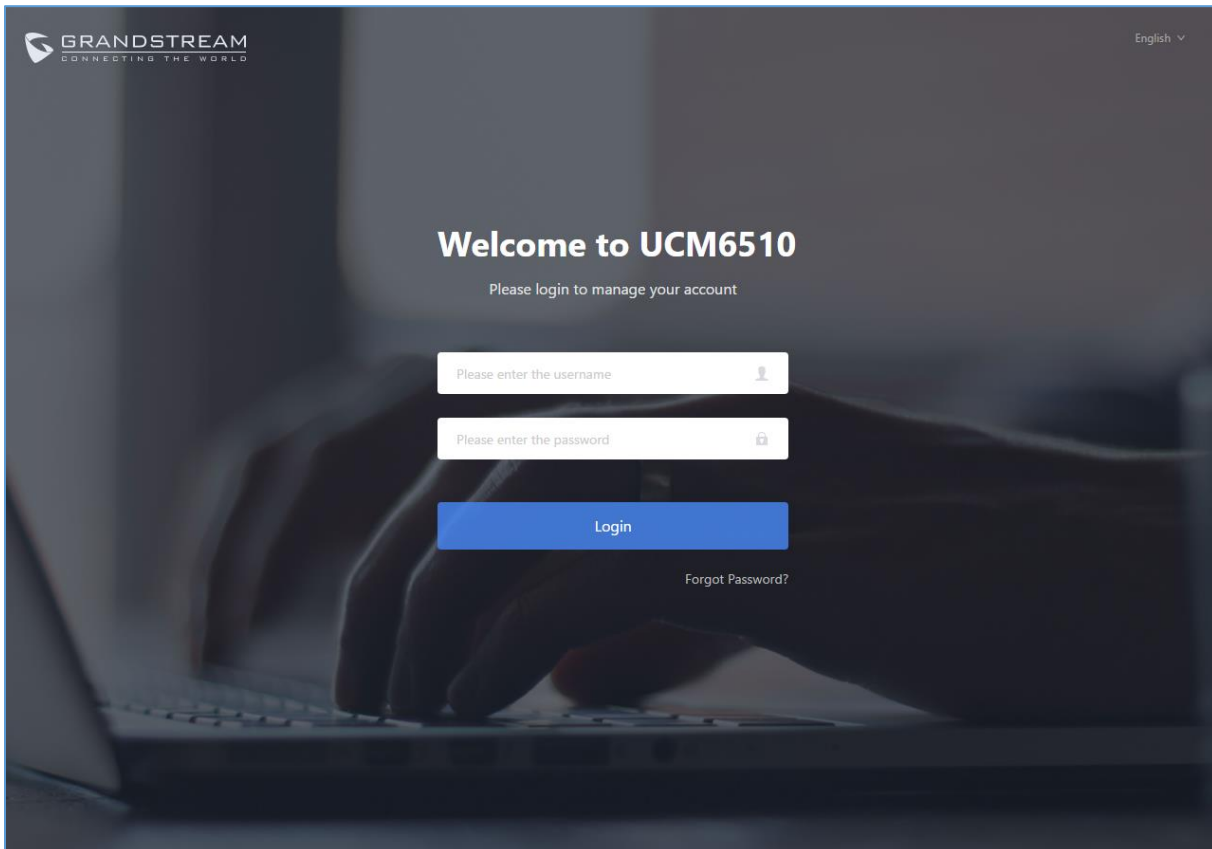
LED Indicator	LED Status
Power 1/Power 2 PoE LAN WAN USB SD Phone 1 /Phone 2 (FXS) Line 1/Line 2 FXO	<ul style="list-style-type: none"> <li>■ <b>Solid:</b> Connected</li> <li>■ <b>Fast Blinking:</b> Data Transferring</li> <li>■ <b>Slow Blinking:</b> Trying to connect</li> <li>■ <b>OFF:</b> Not Connected</li> </ul>
T1/E1/J1	<ul style="list-style-type: none"> <li>■ <b>Solid:</b> Connected and working</li> <li>■ <b>Fast Blinking (0.5s on/0.5s off):</b> No connection is detected.</li> <li>■ <b>Slow Blinking (1s on/1s off):</b> Connected but the link is only working one-way</li> </ul>



## Using the Web UI

### Accessing the Web UI

The UCM's web server responds to HTTP/HTTPS GET/POST requests. Embedded HTML pages allow users to configure the device through a web browser such as Microsoft IE (version 8+), Mozilla Firefox, Google Chrome, etc. To access the UCM's web portal, follow the steps below:



**Figure 4: UCM6510 Web GUI Login Page**

1. Make sure your computer is on the same network as the UCM.
2. Make sure that the UCM's IP address is displayed on its LCD.
3. Enter the UCM's IP address into a web browsers' address bar. The login page should appear (please see the above image).
4. Enter default administrator username "admin" and password.

**Note:** Units manufactured starting January 2017 have a unique random password printed on the sticker located on the back of the unit. It is highly recommended to change the default password after logging in for the first time. Older units have default password "admin".



---

 **Note:**

By default, the UCM6510 has **Redirect From Port 80** enabled. As such, if users type in the UCM6510 IP address in the web browser, the web page will be automatically redirected to the page using HTTPS and port 8089.

For example, if the LCD shows 192.168.40.167, and 192.168.40.167 is entered into the web browser, the web page will be redirected to:

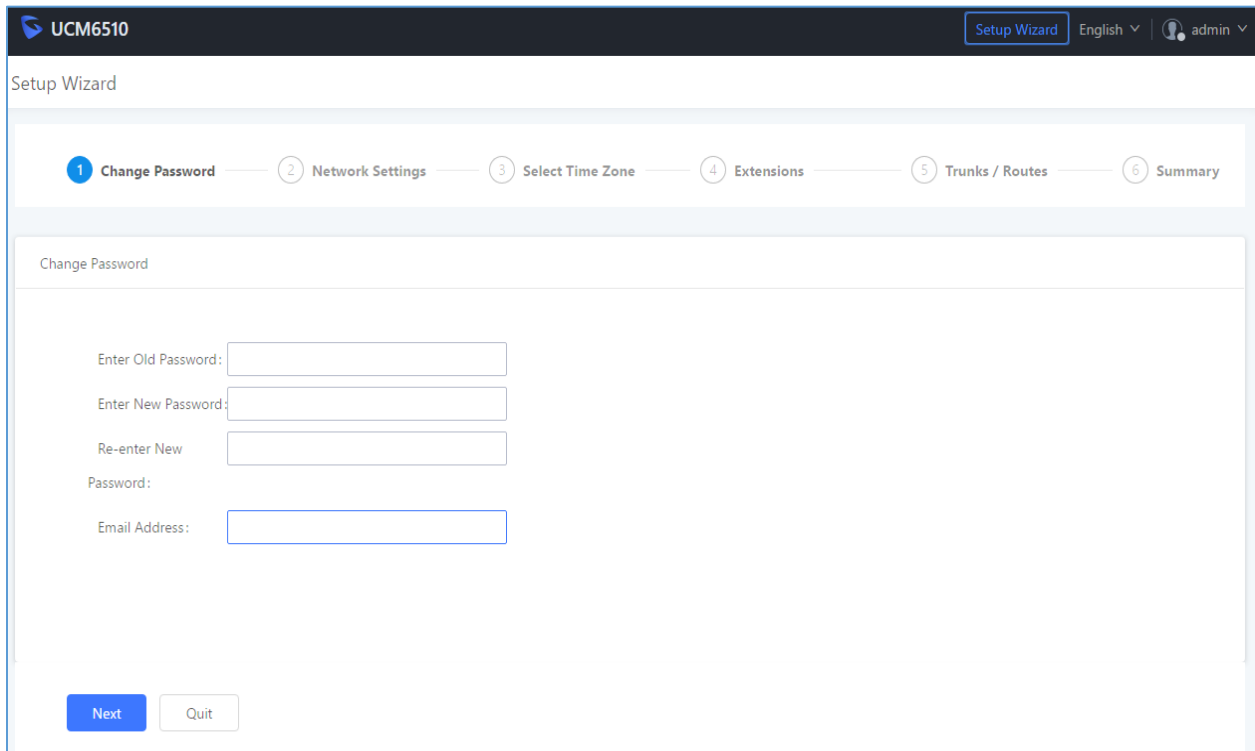
<https://192.168.40.167:8089>

The option **Redirect From Port 80** can be found under the UCM6510 Web GUI→**System Settings**→**HTTP Server**.

---

## Setup Wizard

After logging into the UCM web portal for the first time, the setup wizard will guide the user through basic configurations such as time zone, network settings, trunks, and routing rules.



**Figure 5: UCM6510 Setup Wizard**

The setup wizard can be closed and reopened at any time. At the end of the wizard, a summary of the pending configuration changes can be reviewed before applying them.



## Main Settings

There are 8 main sections in the web portal to manage various features of the UCM.

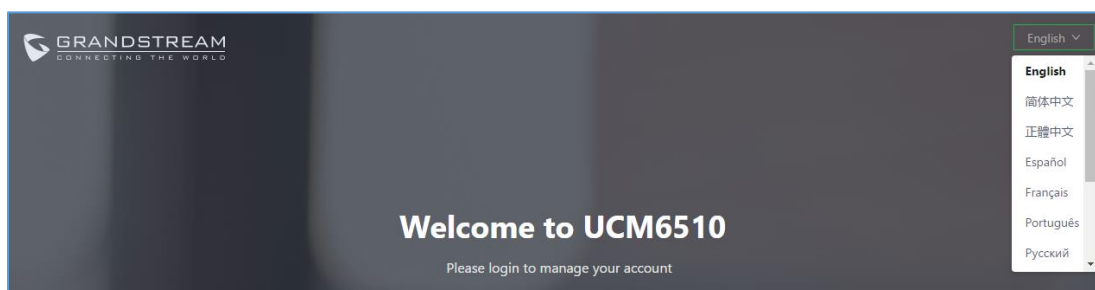
- **System Status:** Displays the dashboard, system information, current active calls, and network status.
- **Extensions/Trunks:** Manages extensions, trunks, and routing rules.
- **Call Features:** Manages various features of the UCM such as the IVR and voicemail.
- **PBX Settings:** Manages the settings related to PBX functionality such as SIP settings and interface settings.
- **System Settings:** Manages the settings related to the UCM system itself such as network and security settings.
- **CDR:** Contains the call detail records, statistics, and audio recordings of calls processed by the UCM.
- **Value-Added Features:** Manages the settings of features unrelated to core PBX functionality such as Zero Config provisioning and CRM/PMS integrations.
- **Maintenance:** Manages settings and logs related to system management and maintenance such as user management, activity logs, backup settings, upgrade settings and troubleshooting tools.

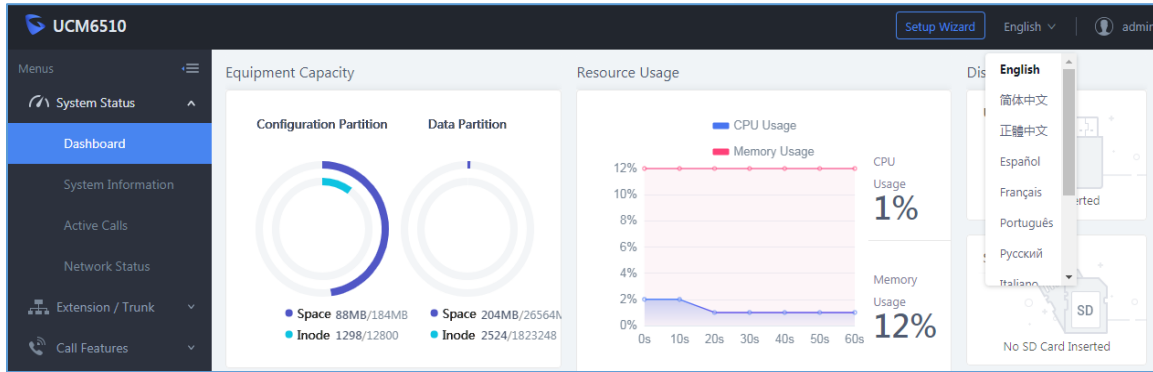
## Web GUI Languages

Currently the UCM6510 Web GUI supports the following languages:

**English, Simplified Chinese, Traditional Chinese, Spanish, French, Portuguese, Russian, Italian, Polish, German.**

Users can select the UCM's web UI display language in the top-right corner of the page.

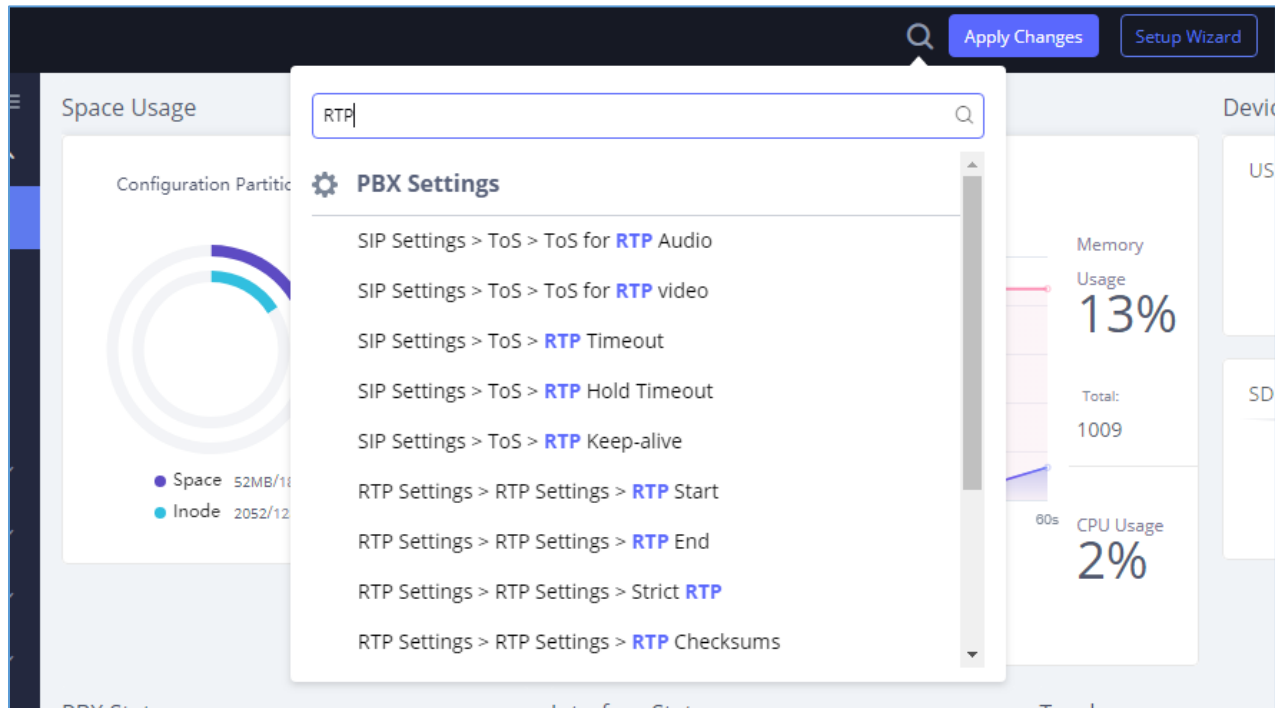




**Figure 6: UCM6510 Web GUI Language**

## Web GUI Search Bar

Users can search for options in the web portal with the search bar on the top right of the page.

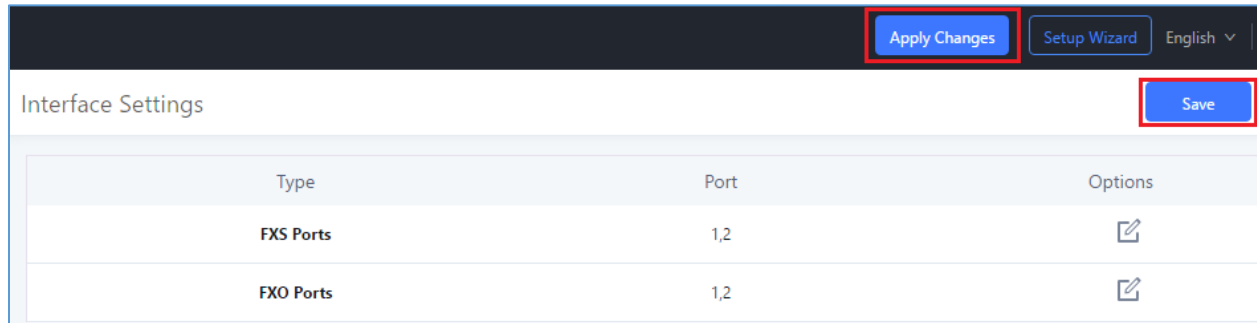


**Figure 7: Web GUI Search Bar**

## Saving and Applying Changes

After making changes to a page, click on the "Save" button to save them and then the "Apply Changes" button that appears to finalize the changes. If a modification requires a reboot, a prompt will appear asking to reboot the device.





**Figure 8: UCM6510 Web GUI: Apply Changes**

## Setting Up an Extension

Power on the UCM6510 and your SIP endpoint. Connect both devices to the same network and follow the steps below to set up an extension.

1. Log into the UCM web portal and navigate to **Extension/Trunk→Extensions**
2. Click on the "Add" button to start creating a new extension. The Extension and SIP/IAX Password information will be used to register to this extension. To set up voicemail, the Voicemail Password will be required.
3. To register an endpoint to this extension, go into your endpoint's web UI and edit the desired account. Enter the newly created extension's number, SIP user ID, and password into their corresponding fields on the endpoint. Enter the UCM's IP address into the SIP server field. If setting up voicemail, enter \*97 into the Voice Mail Access Number field. This field may be named differently on other devices.
4. To access the extension's voicemail, use the newly registered extension to dial \*97 and access the personal voicemail system. Once prompted, enter the voicemail password. If successful, you will now be prompted with various voicemail options.
5. You have now set up an extension on an endpoint.





## SYSTEM SETTINGS

This section will explain the available system-wide parameters and configuration options on the UCM6510. This includes settings for the following items: HTTP server, network, OpenVPN, DDNS, LDAP server, email server, and HA.

### HTTP Server

The UCM6510's embedded web server responds to HTTP/HTTPS GET/POST requests and allows users to configure the UCM via web browsers such as Microsoft IE, Mozilla Firefox, and Google Chrome. By default, users can access the UCM by just typing its IP address into a browser address bar. The browser will automatically be redirected to HTTPS using port 8089. For example, typing in "192.168.40.50" into the address bar will redirect the browser to "https://192.168.40.50:8089". This behavior can be changed in the **System Settings->HTTP Server** page.

**Table 5: HTTP Server Settings**

<b>Redirect From Port 80</b>	Toggles automatic redirection to UCM's web portal from port 80. If disabled, users will need to manually add the UCM's configured HTTP/HTTPS port to the server address when accessing the UCM web portal via browser. Default is "Enabled".
<b>Protocol Type</b>	Select either HTTP or HTTPS as the protocol to access the UCM's HTTP server. This will also determine what is used when endpoints download config files from the UCM via Zero Config. Default is "HTTPS".
<b>Port</b>	Specifies the port number used to access the UCM HTTP server. Default is "8089".
<b>Enable IP Whitelist</b>	If enabled, only the server addresses in whitelist will be able to access the UCM's web portal. It is highly recommended to add the IP address currently used to access the UCM web page before enabling this option. Default is "Disabled".
<b>Permitted IP(s)</b>	List of addresses that can access the UCM web portal. Ex: 192.168.6.233 / 255.255.255.255
<b>Certificate Options</b>	Selects the method of acquiring SSL certificates for the UCM web server. Two methods are currently available: <ul style="list-style-type: none"> <li>- Upload Certificate: Upload the appropriate files from one's own PC.</li> <li>- Request Certificate: Enter the domain for which to request a certificate for from Let's Encrypt.</li> </ul>



<b>TLS Private Key</b>	Uploads the private key for the HTTP server.  <b>Note:</b> Key file must be under 2MB in file size and in *.pem format. File name will automatically be changed to "private.pem".
<b>TLS Cert</b>	Uploads the certificate for the HTTP server.  <b>Note:</b> Certificate must be under 2MB in file size and in *.pem format. This will be used for TLS connections and contains private key for the client and signed certificate for the server.
<b>Domain</b>	Enter the domain to request the certificate for and click on <a href="#">Request Certificate</a> to request the certificate.

If the protocol or port has been changed, the user will be logged out and redirected to the new URL.

## Network Settings

After successfully connecting the UCM6510 to the network for the first time, users could log in the Web GUI and go to **System Settings**→**Network Settings** to configure the network parameters for the device. Select each tab in Web GUI→**System Settings**→**Network Settings** page to configure LAN/WAN settings, 802.1X and Port Forwarding.

---

### Note:

UCM6510 can also connect to network via E1/T1/J1 data trunk instead of using the WAN/LAN ports. Please see section **[DATA TRUNK]** for more details.

---

## Basic Settings

Please refer to the following tables for basic network configuration parameters on the UCM6510.

**Table 6: UCM6510 System Settings → Network Settings→Basic Settings**

<b>Method</b>	Select "Route", "Switch" or "Dual" mode on the network interface of UCM6510. The default setting is "Route". <ul style="list-style-type: none"> <li>• <b>Route</b> WAN port will be used for uplink connection. LAN port will function similarly to a regular router port.</li> <li>• <b>Switch</b> WAN port will be used for uplink connection. LAN port will be used as a bridge for connections.</li> </ul>
---------------	--



	<ul style="list-style-type: none"> <li>• <b>Dual</b> Both WAN and LAN ports will be used for uplink connections labeled as LAN2 and LAN1, respectively. The port selected as the Default Interface will need to have a gateway IP address configured if it is using a static IP.</li> </ul>
<b>MTU</b>	Specifies the maximum transmission unit value. Default is 1500.
<b>IPv4 Address</b>	
<b>Preferred DNS Server</b>	If configured, this will be used as the Primary DNS server.
<b>WAN (when "Method" is set to "Route")</b>	
<b>IP Method</b>	Select DHCP, Static IP, or PPPoE. The default setting is DHCP.
<b>IP Address</b>	Enter the IP address for static IP settings. The default setting is 192.168.0.160.
<b>Subnet Mask</b>	Enter the subnet mask address for static IP settings. The default setting is 255.255.0.0.
<b>Gateway IP</b>	Enter the gateway IP address for static IP settings. The default setting is 0.0.0.0.
<b>DNS Server 1</b>	Enter the DNS server 1 address for static IP settings. The default setting is 0.0.0.0.
<b>DNS Server 2</b>	Enter the DNS server 2 address for static IP settings.
<b>Username</b>	Enter the username to connect via PPPoE.
<b>Password</b>	Enter the password to connect via PPPoE.
<b>Layer 2 QoS 802.1Q/VLAN Tag</b>	Assign the VLAN tag of the layer 2 QoS packets for WAN port. The default value is 0.
<b>Layer 2 QoS 802.1p Priority Value</b>	Assign the priority value of the layer 2 QoS packets for WAN port. The default value is 0.
<b>LAN (when Method is set to "Route")</b>	
<b>IP Address</b>	Enter the IP address assigned to LAN port. The default setting is 192.168.2.1.
<b>Subnet Mask</b>	Enter the subnet mask. The default setting is 255.255.255.0.
<b>DHCP Server Enable</b>	Enable or disable DHCP server capability. The default setting is "Yes".
<b>DNS Server 1</b>	Enter DNS server address 1. The default setting is 8.8.8.8.
<b>DNS Server 2</b>	Enter DNS server address 2. The default setting is 208.67.222.222.
<b>Allow IP Address From</b>	Enter the DHCP IP Pool starting address. The default setting is 192.168.2.100.
<b>Allow IP Address To</b>	Enter the DHCP IP Pool ending address. The default setting is 192.168.2.254.
<b>Default IP Lease Time</b>	Enter the IP lease time (in seconds). The default setting is 43200.
<b>LAN (when Method is set to "Switch")</b>	
<b>IP Method</b>	Select DHCP, Static IP, or PPPoE. The default setting is DHCP.
<b>IP Address</b>	Enter the IP address for static IP settings. The default setting is 192.168.0.160.



<b>Subnet Mask</b>	Enter the subnet mask address for static IP settings. The default setting is 255.255.0.0.
<b>Gateway IP</b>	Enter the gateway IP address for static IP settings. The default setting is 0.0.0.0.
<b>DNS Server 1</b>	Enter the DNS server 1 address for static IP settings. The default setting is 0.0.0.0.
<b>DNS Server 2</b>	Enter the DNS server 2 address for static IP settings.
<b>Username</b>	Enter the username to connect via PPPoE.
<b>Password</b>	Enter the password to connect via PPPoE.
<b>Layer 2 QoS 802.1Q/VLAN Tag</b>	Assign the VLAN tag of the layer 2 QoS packets for LAN port. The default value is 0.
<b>Layer 2 QoS 802.1p Priority Value</b>	Assign the priority value of the layer 2 QoS packets for LAN port. The default value is 0.
<b>LAN 1 / LAN 2 (when Method is set to "Dual")</b>	
<b>Default Interface</b>	If "Dual" is selected as "Method", users will need assign the default interface to be LAN 1 (mapped to UCM6510 WAN port) or LAN 2 (mapped to UCM6510 LAN port) and then configure network settings for LAN1 and LAN 2. Default interface is LAN2.
<b>IP Method</b>	Select DHCP, Static IP, or PPPoE. The default setting is DHCP.
<b>IP Address</b>	Enter the IP address for static IP settings. The default setting is 192.168.0.160.
<b>Subnet Mask</b>	Enter the subnet mask address for static IP settings. The default setting is 255.255.0.0.
<b>Gateway IP</b>	Enter the gateway IP address for static IP settings when the port is assigned as default interface. The default setting is 0.0.0.0.
<b>DNS Server 1</b>	Enter the DNS server 1 address for static IP settings. The default setting is 0.0.0.0.
<b>DNS Server 2</b>	Enter the DNS server 2 address for static IP settings.
<b>Username</b>	Enter the username to connect via PPPoE.
<b>Password</b>	Enter the password to connect via PPPoE.
<b>Layer 2 QoS 802.1Q/VLAN Tag</b>	Assign the VLAN tag of the layer 2 QoS packets for LAN port. Default value is 0.
<b>Layer 2 QoS 802.1p Priority Value</b>	Assign the priority value of the layer 2 QoS packets for LAN port. The default value is 0.
<b>IPv6 Address</b>	
<b>WAN (when "Method" is set to "Route")</b>	
<b>IP Method</b>	Select Auto or Static. The default setting is Auto
<b>IP Address</b>	Enter the IP address for static IP settings.
<b>IP Prefixlen</b>	Enter the Prefix length for static settings. Default is 64
<b>DNS Server 1</b>	Enter the DNS server 1 address for static settings.
<b>DNS Server 2</b>	Enter the DNS server 2 address for static settings.



LAN (when Method is set to "Route")	
<b>DHCP Server</b>	Select Disable, Auto or DHCPv6. <b>Disable:</b> Disable the DHCPv6 server. <b>Auto:</b> Stateless address auto configuration using NDP protocol. <b>DHCPv6:</b> Stateful address auto configuration using DHCPv6 protocol.
<b>DHCP Prefix</b>	Enter DHCP prefix. (Default is 2001:db8:2:2::)
<b>DHCP prefixlen</b>	Enter the Prefix length for static settings. Default is 64
<b>DNS Server 1</b>	Enter the DNS server 1 address for static settings. Default is (2001:4860:4860::8888)
<b>DNS Server 2</b>	Enter the DNS server 2 address for static settings. Default is (2001:4860:4860::8844)
<b>Allow IP Address From</b>	Configure starting IP address assigned by the DHCP prefix and DHCP prefixlen.
<b>Allow IP Address To</b>	Configure the ending IP address assigned by the DHCP Prefix and DHCP prefixlen.
<b>Default IP Lease Time</b>	Configure the lease time (in seconds) of the IP address.
LAN (when Method is set to "Switch")	
<b>IP Method</b>	Select Auto or Static. The default setting is Auto
<b>IP Address</b>	Enter the IP address for static IP settings.
<b>IP Prefixlen</b>	Enter the Prefix length for static settings. Default is 64
<b>DNS Server 1</b>	Enter the DNS server 1 address for static settings.
<b>DNS Server 2</b>	Enter the DNS server 2 address for static settings.
LAN 1 / LAN 2 (when Method is set to "Dual")	
<b>Default Interface</b>	Users must select either LAN 1 (WAN port) or LAN 2 (LAN port) to be used as the default interface. Default setting is LAN 2.
<b>IP Method</b>	Select Auto or Static. The default setting is Auto
<b>IP Address</b>	Enter the IP address for static IP settings.
<b>IP Prefixlen</b>	Enter the Prefix length for static settings. Default is 64
<b>DNS Server 1</b>	Enter the DNS server 1 address for static settings.
<b>DNS Server 2</b>	Enter the DNS server 2 address for static settings.



- **Method: Route**

WAN port interface is used for uplink connection; LAN port interface is used as a router. Please see the sample diagram below.

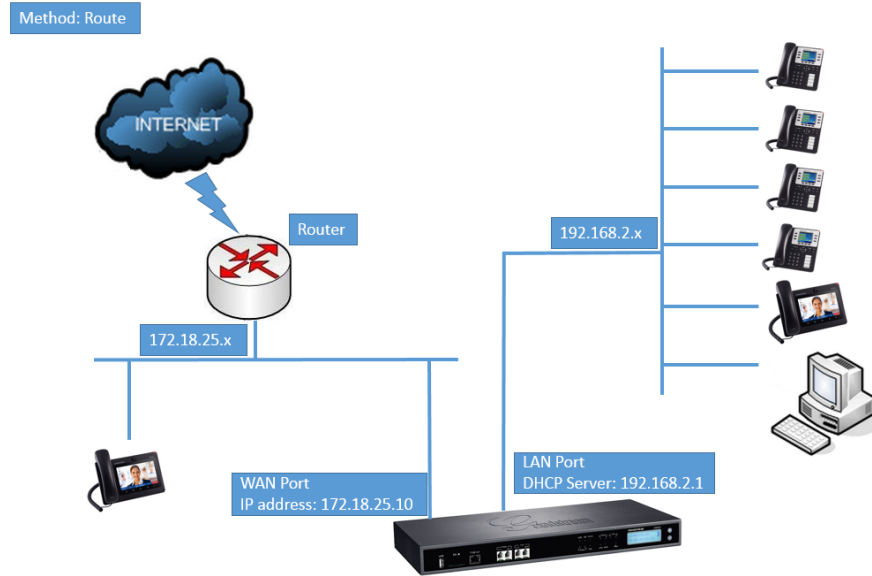


Figure 9: UCM6510 Network Interface Method: Route

- **Method: Switch**

WAN port interface is used for uplink connection; LAN port interface is used as bridge for PC connection.

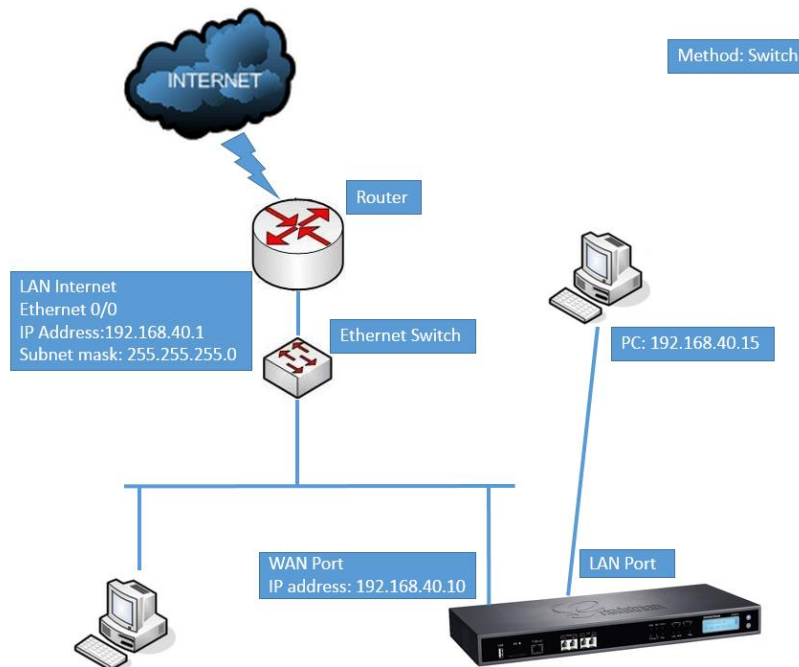


Figure 10: UCM6510 Network Interface Method: Switch

- **Method: Dual**

Both WAN port and LAN port are used for uplink connection. WAN port will be mapped to LAN 1 interface; LAN port will be mapped to LAN 2 interface. Users will need assign LAN 1 or LAN 2 as the default interface in option “Default Interface” and configure “Gateway IP” if static IP is used for this interface.

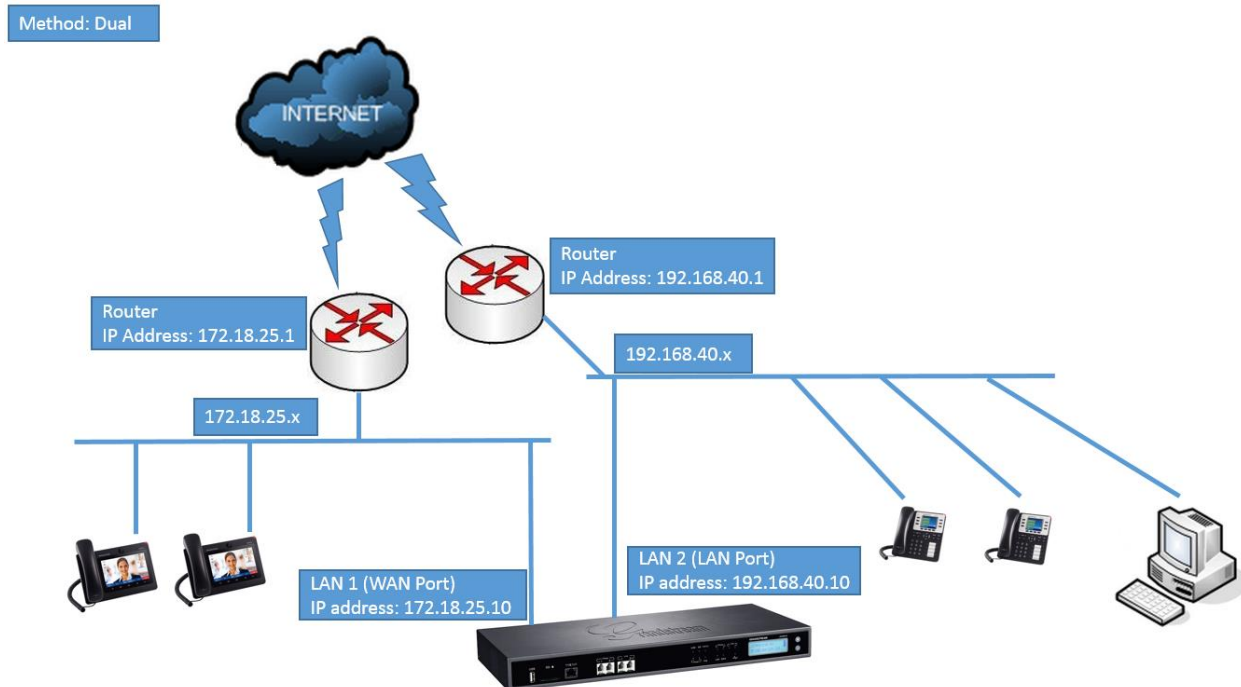


Figure 11: UCM6510 Network Interface Method: Dual

## DHCP Client List

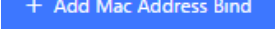
This page lists all the detected devices on the LAN and the IP addresses that were provided to them. Additionally, users can manually link a MAC address to an IP address.

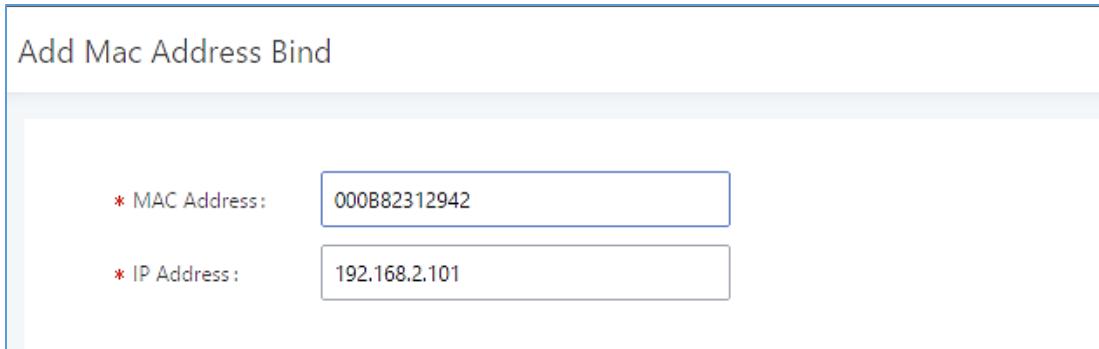
When devices receive IP addresses from the UCM's DHCP server, they will be listed in the **System Settings**→**Network Settings**→**DHCP Client List** page as shown below:

Network Settings				
Basic Settings	<u>DHCP Client List</u>	802.1X Settings	Static Routes	Port Forwarding
<input type="button" value="+ Add Mac Address Bind"/> <input type="button" value="Batch add MAC addresses to bind"/> <input type="button" value="Batch Release MAC Address Bind"/>				
<input type="checkbox"/>	MAC Address ⇅	IP Address ⇅	Bind Status ⇅	Options
<input type="checkbox"/>	dc4a3e78dd25	192.168.2.100	Unbind	

Figure 12: DHCP Client List

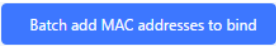



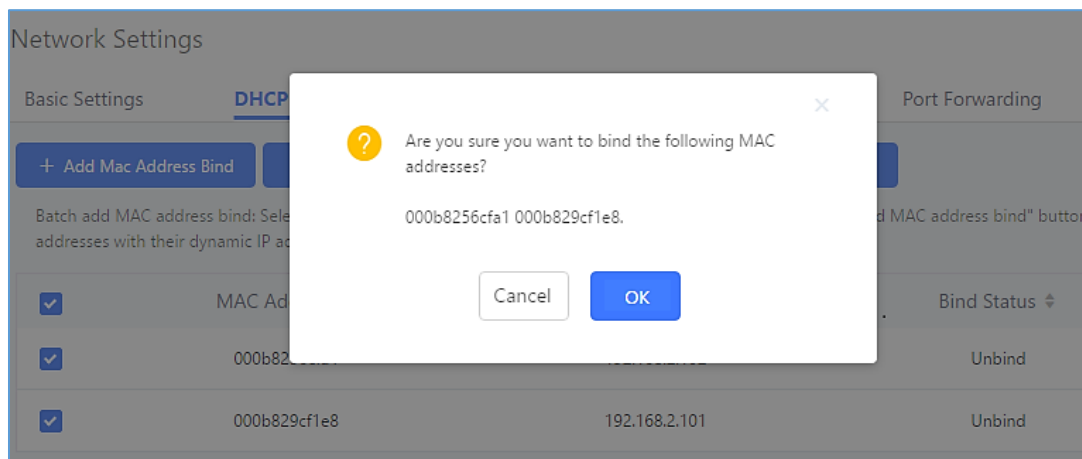
To manually add and bind a MAC address to an IP address, click on . The following menu will then be displayed.



**Figure 13: Add MAC Address Bind**

Enter the device's MAC address and the IP address to bind it to. This IP address must be in the UCM's DHCP range.

To bind multiple existing MAC addresses that are in the list to their respective IP addresses, check the boxes next to each MAC address and click on the  button. A confirmation message will appear on the screen. Click  to bind the addresses.



**Figure 14: Batch Add MAC Address Bind**

The Bind Status for the selected MAC addresses should now be changed from "Unbound" to "Bound".

Reviewer note: the 1.0.20.x text will be changed from "Unbind" to "Unbound" and "Binding" to "Bound".



## 802.1X

IEEE 802.1X is an IEEE standard for port-based network access control. It provides an authentication mechanism to device before the device is allowed to access Internet or other LAN resources. The UCM6510 supports 802.1X as a supplicant/client to be authenticated.

The following diagram and figure show UCM6510 use 802.1X mode “EAP-MD5” on WAN port as client in the network to access Internet.

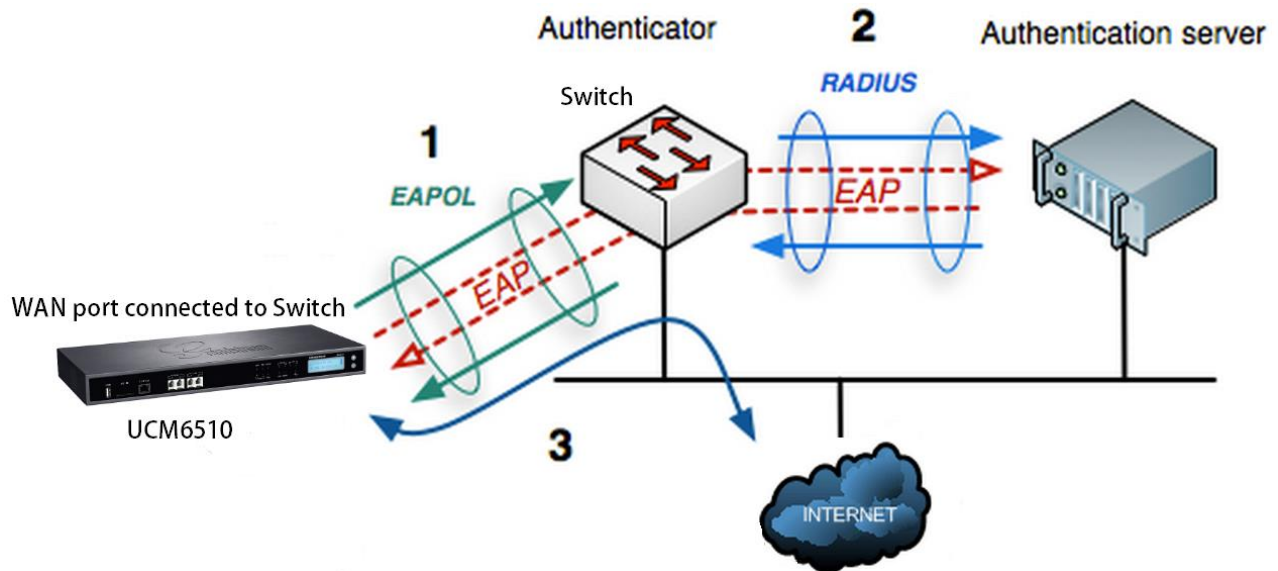


Figure 15: UCM6510 using 802.1X as Client

Network Settings				
Basic Settings	DHCP Client List	<u>802.1X Settings</u>	Static Routes	Port Forwarding
WAN				
802.1X Mode:	EAP-MD5			
* Identity:	8021xxUCM6202			
* MD5 Password:	.....			

Figure 16: UCM6510 using 802.1X EAP-MD5

The following table shows the configuration parameters for 802.1X on UCM6510. Identity and MD5







password are required for authentication, which should be provided by the network administrator obtained from the RADIUS server. If “EAP-TLS” or “EAP-PEAPv0/MSCHAPv2” is used as the 802.1X mode, users will also need upload 802.1X CA Certificate and 802.1X Client Certificate, which should be also generated from the RADIUS server.

**Table 7: UCM6510 Network Settings→802.1X**

<b>802.1X Mode</b>	Select 802.1X mode. The default setting is “Disable”. The supported 802.1X modes are: <ul style="list-style-type: none"> <li>• <b>EAP-MD5</b></li> <li>• <b>EAP-TLS</b></li> <li>• <b>EAP-PEAPv0/MSCHAPv2</b></li> </ul>
<b>Identity</b>	Enter 802.1X mode Identity information.
<b>MD5 Password</b>	Enter 802.1X mode MD5 password information.
<b>802.1X CA Certificate</b>	Select 802.1X certificate from local PC and then upload.
<b>802.1X Client Certificate</b>	Select 802.1X client certificate from local PC and then upload.

## Static Routes

A static route is a pre-determined path that the network traffic travels to reach a specific host or network. On the UCM6510, the static route function allows the device to use manually configured routes, instead of dynamically assigned routes or the default gateway. Static routes can be used to define a route when no others are available or can serve as complementary routes alongside existing routes as failover routes with existing routing on the UCM6510 as a failover backup, and etc.

- Click on  to create a new IPv4 static route or click on  to create a new IPv6 static route. The configuration parameters are listed in the table below.
- Once added, users can select  to edit the static route.
- Select  to delete the static route.
- Static routes configuration can be reset from LCD menu→Network Menu.

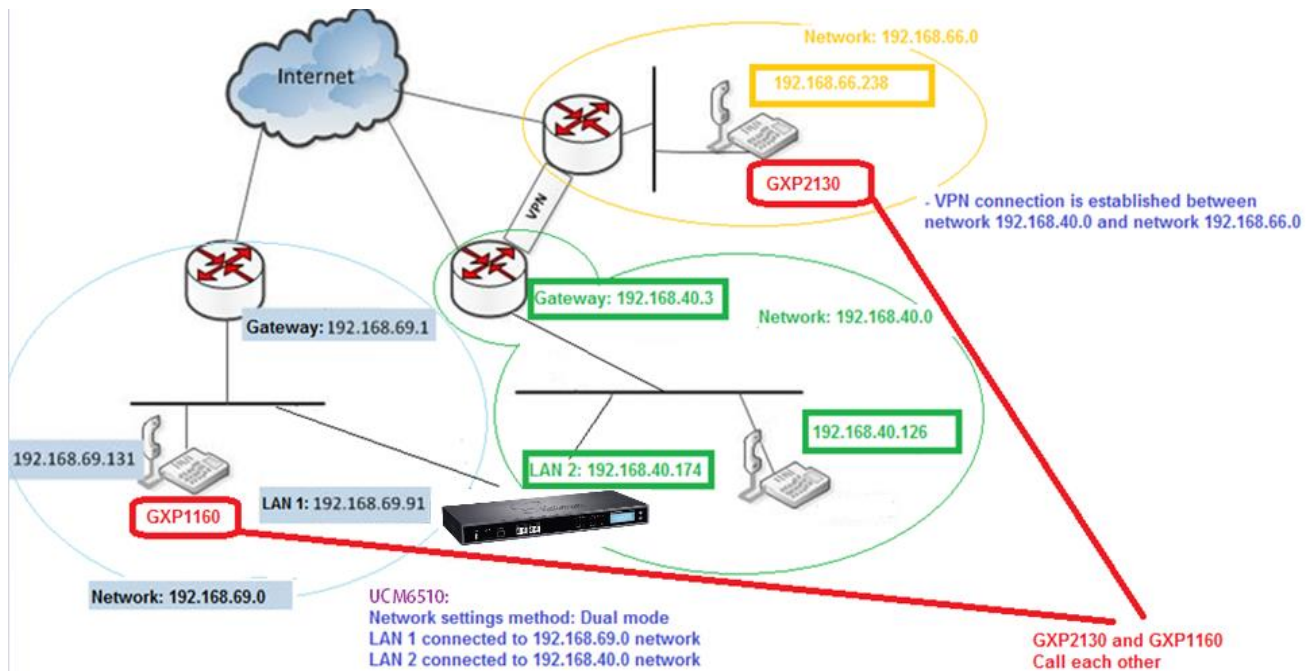
**Table 8: UCM6510 Network Settings→Static Routes**

<b>Destination</b>	Configure the destination IPv4 address or the destination IPv6 subnet for the UCM6510 to reach using the static route. Example:
--------------------	--



	IPv4 address - <b>192.168.66.4</b> IPv6 subnet - <b>2001:740:D::1/64</b>
<b>Netmask</b>	Configure the subnet mask for the above destination address. If left blank, the default value is 255.255.255.255. <u>Example:</u> <b>255.255.255.0</b>
<b>Gateway</b>	Configure the IPv4 or IPv6 gateway address so that the UCM6510 can reach the destination via this gateway. Gateway address is optional. Example: <b>192.168.40.5</b> or <b>2001:740:D::1</b>
<b>Interface</b>	Specify the network interface “LAN”, “WAN” or “Data trunk 1” (“Data Trunk 1” option will show only when the data trunk is enabled) on the UCM6510 to reach the destination using the static route.

The following diagram shows a sample application of static route usage on UCM6510.



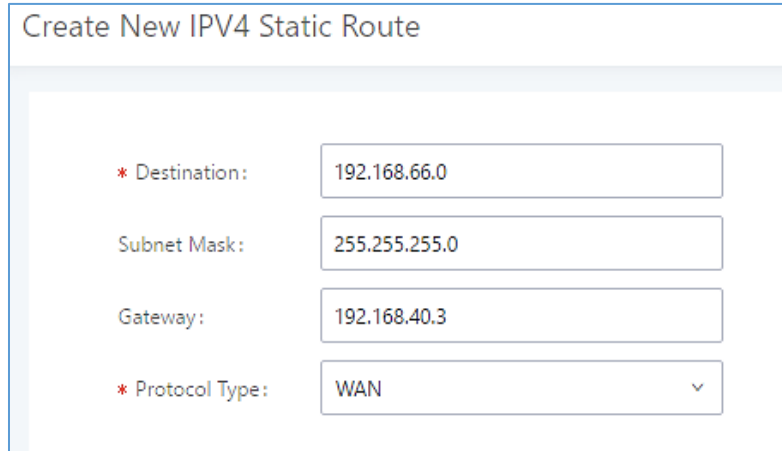
**Figure 17: UCM6510 Static Route Sample**

The network topology of the above diagram is as below:

- Network 192.168.69.0 has IP phones registered to UCM6510 LAN 1 address
- Network 192.168.40.0 has IP phones registered to UCM6510 LAN 2 address
- Network 192.168.66.0 has IP phones registered to UCM6510 via VPN
- Network 192.168.40.0 has VPN connection established with network 192.168.66.0



In this network, by default the IP phones in network 192.168.69.0 are unable to call IP phones in network 192.168.66.0 when registered on different interfaces on the UCM6510. Therefore, we need configure a static route on the UCM6510 so that the phones in isolated networks can make calls between each other.



**Create New IPV4 Static Route**

\* Destination: 192.168.66.0

Subnet Mask: 255.255.255.0

Gateway: 192.168.40.3

\* Protocol Type: WAN

**Figure 18: UCM6510 Static Route Configuration**

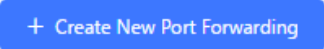
## Port Forwarding

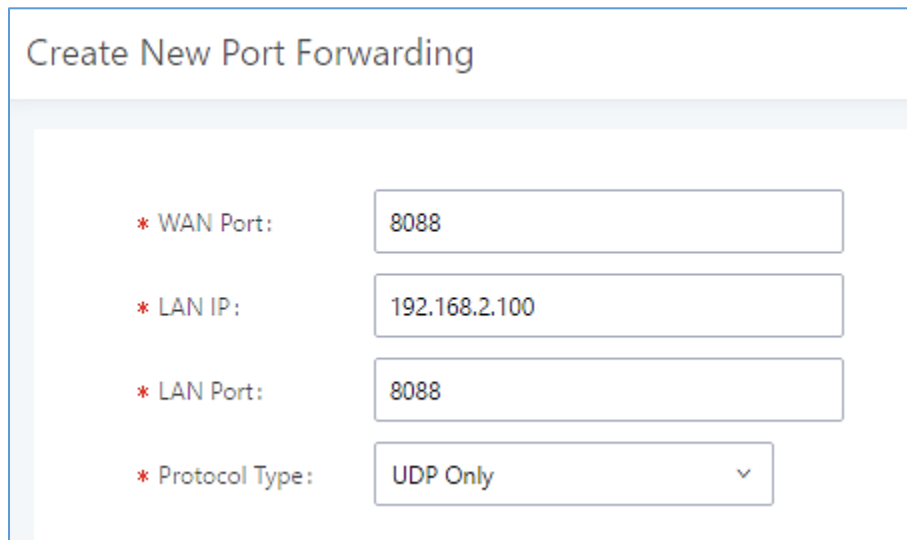
The UCM network interface supports router functionality that allows users to configure port forwarding. If the UCM is set to "Route" in **System Settings**→**Network Settings**→**Basic Settings**→**Method**, the Port Forwarding tab will be available.

**Table 9: UCM6510 System Settings → Network Settings→Port Forwarding**

<b>WAN Port</b>	Specify the WAN port number or a range of WAN ports. Unlimited number of ports can be configured. <b>Note:</b> When set to a range, both the WAN port and LAN port must be configured with the same range (e.g., WAN port: 1000-1005, LAN port: 1000-1005). Access from the WAN port will be forwarded to the LAN port with the same port number.
<b>LAN IP</b>	Specify the LAN IP address.
<b>LAN Port</b>	Specify the LAN port number or a range of LAN ports. Please see the note for WAN Port" instead of repeating the note.
<b>Protocol Type</b>	Select protocol type "UDP Only", "TCP Only" or "TCP/UDP" for the forwarding in the selected port. The default setting is "UDP Only".

Here is an example of an environment and how to configure port forwarding to an endpoint's web portal:

- Configure the UCM as a router by selecting "Route" in **System Settings**→**Network Settings**→**Basic Settings**→**Method**.
  - WAN port is connected to an uplink switch with a public IP address configured (e.g., 1.1.1.1).
  - LAN port provides a DHCP pool for devices on the LAN network (gateway address is 192.168.2.1 by default).
- Connect a GXP2160 to the UCM's LAN network. It should obtain an IP address from UCM's DHCP pool.
- While still on the Network Settings page, navigate to the Port Forwarding tab.
- Click on  button to start setting up port forwarding.



The screenshot shows a web interface for configuring port forwarding. The title is "Create New Port Forwarding". There are four fields with red asterisks indicating required information:

- WAN Port:** Input field containing "8088".
- LAN IP:** Input field containing "192.168.2.100".
- LAN Port:** Input field containing "8088".
- Protocol Type:** A dropdown menu currently showing "UDP Only".

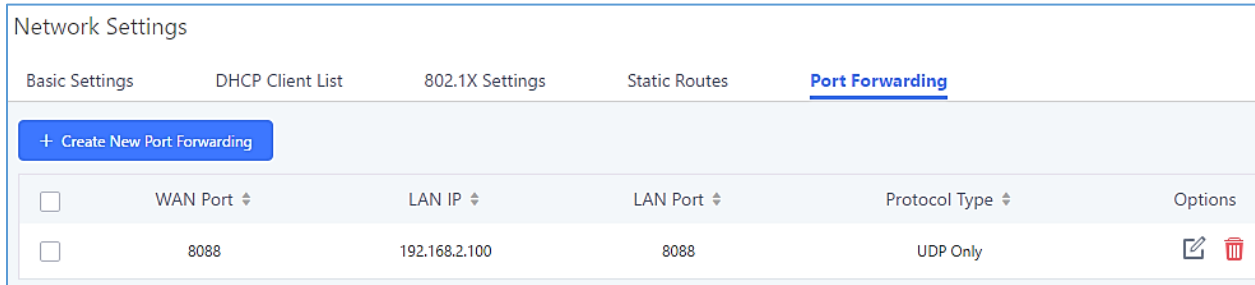
**Figure 19: Create New Port Forwarding**

**WAN Port:** Enter the port that will be opened on the WAN side to allow access.

**LAN IP:** Enter the GXP2160's IP address.

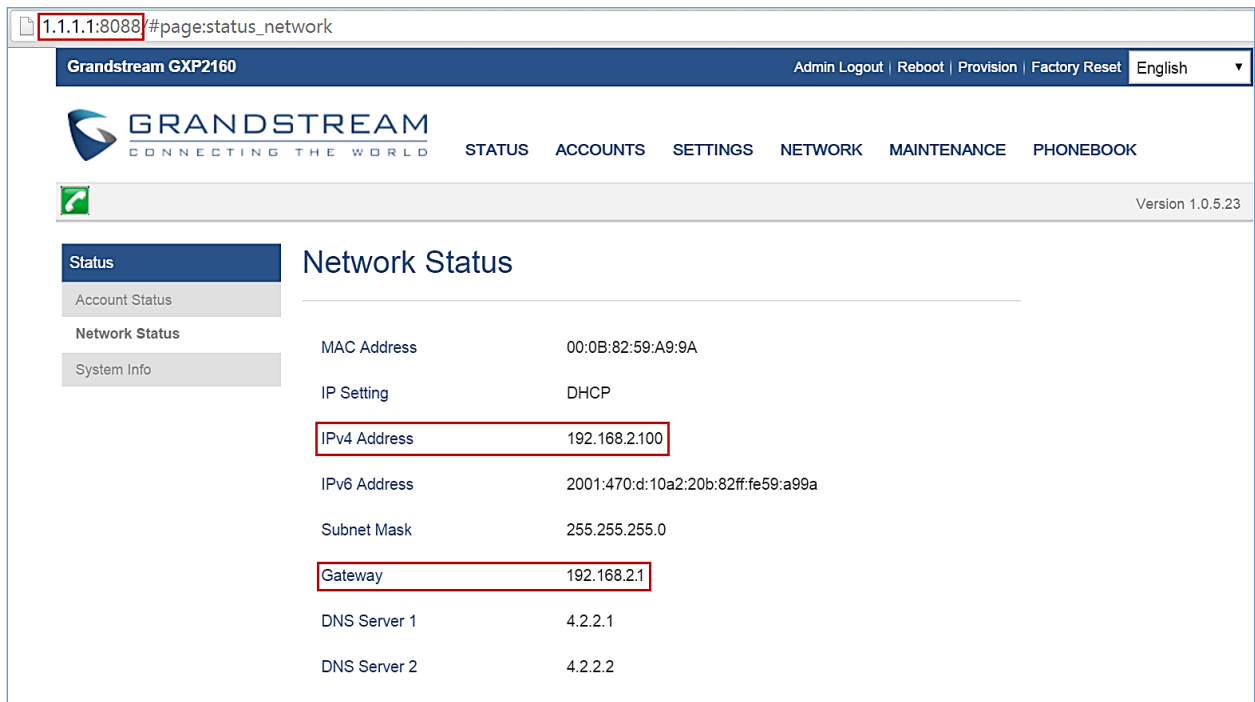
**LAN Port:** Enter the port that will be opened on the GXP2160 to allow access.

**Protocol Type:** Select the protocol to use for this port forwarding.



**Figure 20: UCM6510 Port Forwarding Configuration**

This will allow users to access the GXP2160 web portal from an external network.



**Figure 21: GXP2160 Web Access Using UCM6510 Port Forwarding**

## OpenVPN®

The UCM can be configured as an OpenVPN client.

**Table 10: UCM6510 System Settings→Network Settings→OpenVPN®**

<b>Enable</b>	Enable / Disable the OpenVPN feature.
<b>Configuration Method</b>	Select OpenVPN configuration method. <ul style="list-style-type: none"> <li>• <b>Manual Configuration:</b> Allows to configure OpenVPN settings manually.</li> <li>• <b>Upload Configuration File:</b> Allows to upload .ovpn and .conf files to the UCM and to automatically configure OpenVPN settings.</li> </ul>



<b>OpenVPN® Server Address</b>	Configures the hostname/IP and port of the server. For example: 192.168.1.2:22
<b>OpenVPN® Server Protocol</b>	Specify the protocol user, user should use the same settings as used on the server
<b>OpenVPN® Device mode</b>	Use the same setting as used on the server. <ul style="list-style-type: none"> <li>• <b>Dev TUN:</b> Create a routed IP tunnel.</li> <li>• <b>Dev TAP:</b> Create an Ethernet tunnel.</li> </ul>
<b>OpenVPN® Use Compression</b>	Compress tunnel packets using the LZO algorithm on the VPN link. Do not enable this unless it is also enabled in the server config file.
<b>Allow Weak SSL Ciphers</b>	Enable/Disable allowing Weak SSL Ciphers.
<b>OpenVPN® Encryption Algorithm</b>	Specify the cryptographic cipher. Users should make sure to use the same setting that they are using on the OpenVPN server.
<b>OpenVPN® CA Cert</b>	Upload as SSL/TLS root certificate. This file will be renamed as 'ca.crt' automatically.
<b>OpenVPN® Client Cert</b>	Upload a client certificate. This file will be renamed as 'cliend.crt' automatically.
<b>OpenVPN® Client Key</b>	Upload a client private key. This file will be renamed as 'client.key' automatically.



**OpenVPN®**

OpenVPN® Enable:

Configuration Method: Manual Configuration ^

\* OpenVPN® Server Address: Manual Configuration

OpenVPN® Server Protocol: UDP v

OpenVPN® Device mode: Dev TUN v

OpenVPN® Use Compression:

Allow Weak SSL Ciphers:

OpenVPN® Encryption Algorithm: BF-CBC(Blowfish) v

OpenVPN® CA Cert: Choose File to Upload Delete

OpenVPN® Client Cert: Choose File to Upload Delete

OpenVPN® Client Key: Choose File to Upload Delete

**Figure 22: OpenVPN® feature on the UCM6510**

## DDNS Settings

Configuring UCM DDNS settings will allow the UCM to be accessed via domain name instead of IP address. UCM supports the following DDNS services:

- dydns.org
- noip.com
- freedns.afraid.org
- zoneedit.com
- oray.net

Below is an example of using noip.com for DDNS.

1. Register the desired domain with the DDNS service provider. The UCM must be publicly accessible in order to work with the service provider.





Hostname Information	
Hostname:	haograndstream.ddns.net <span style="float: right;">✔</span>
Host Type:	<input checked="" type="radio"/> DNS Host (A) <input type="radio"/> DNS Host (Round Robin) <input type="radio"/> DNS Alias (CNAME) <span style="float: right;">✔</span> <input type="radio"/> Port 80 Redirect <input type="radio"/> Web Redirect
IP Address:	<input type="text" value="1.2.3.4"/> Last Update: 2015-01-07 17:29:20 PST <span style="float: right;">✔</span>
Assign to Group:	<input type="text" value="- No Group -"/> <span style="float: right;">✔</span> <a href="#">Configure Groups</a>
Enable Wildcard:	Wildcards are a Plus / Enhanced feature. <a href="#">Upgrade Now!</a> <span style="float: right;">✔</span>
Advanced Records:	TXT, SPF, and SRV records and the use of some special clients are Plus / Enhanced features. <a href="#">Upgrade now</a> to use them. <span style="float: right;">✔</span>

Figure 23: Register Domain Name on noip.com

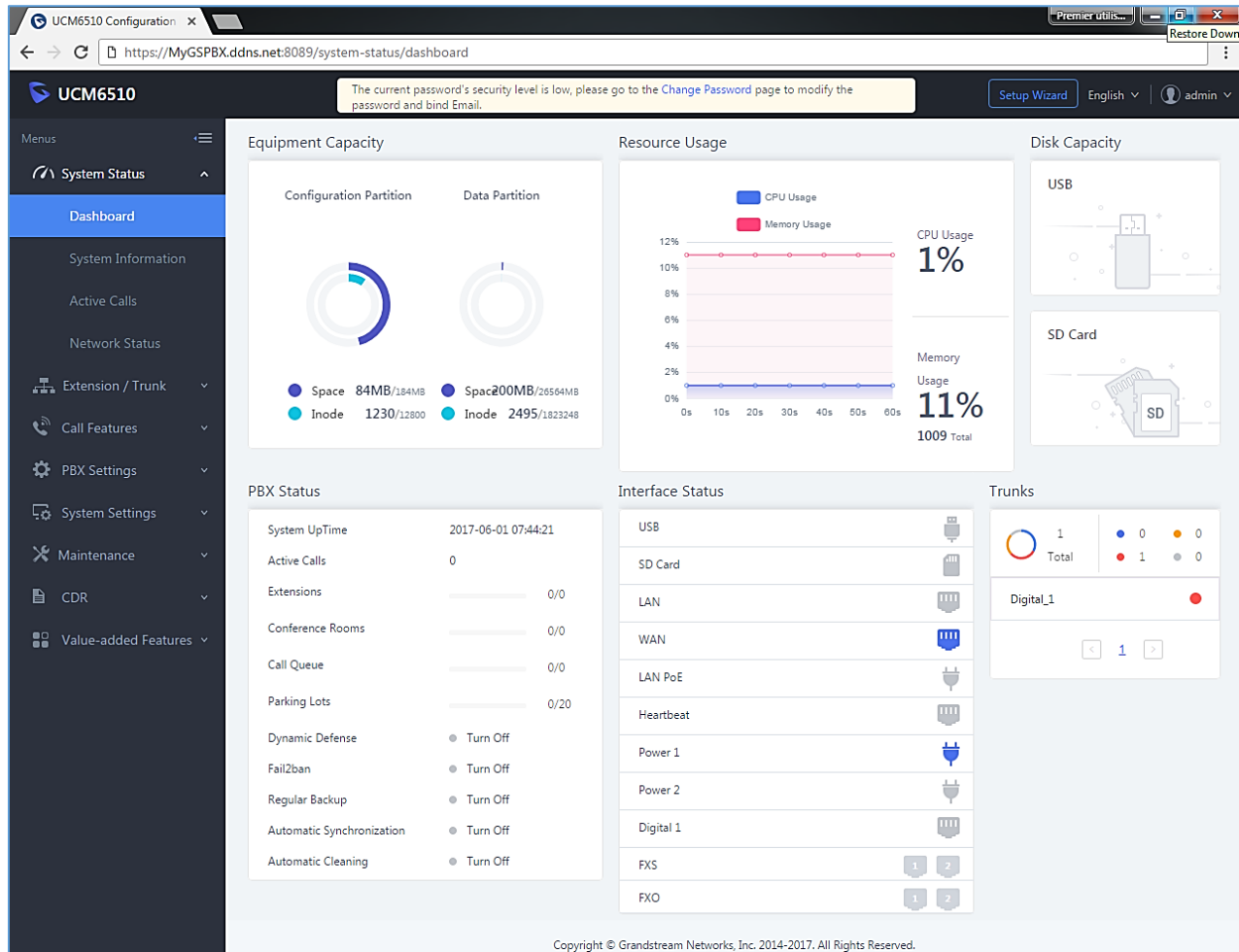
- Navigate to **System Settings**→**Network Settings**→**DDNS Settings**, check the Enable DDNS option, select your service provider, and configure all the displayed fields.

Menus	DDNS Settings
System Status	DDNS Server: <input type="text" value="no-ip.com"/>
Extension / Trunk	Enable DDNS: <input checked="" type="checkbox"/>
Call Features	* Username: <input type="text" value="user_no_IP"/>
PBX Settings	* Password: <input type="text" value="....."/>
<b>System Settings</b>	* Host Name: <input type="text" value="MyGSPBX.ddns.net"/>
HTTP Server	
Network Settings	
OpenVPN	
<b>DDNS Settings</b>	

Figure 24: UCM6510 DDNS Setting

- You can now use the configured domain to access the UCM web portal.





**Figure 25: Using Domain Name to Connect to UCM6510**

## Security Settings

The UCM offers several methods of protection against malicious attacks and unauthorized access such as firewall rules, connection thresholds, and Fail2ban.

To get started on configuring security settings, navigate to the **System Settings** → **Security Settings** page.

## Static Defense

On the Static Defense page, users can configure firewall rules and view the ports used by various UCM services and processes.

The following table shows a few examples of the information available on the Static Defense page.




**Table 11: UCM6510 Security Settings→Static Defense→Current Service**

Port	Process	Type
7777	Asterisk	TCP/IPv4
389	Slapd	TCP/IPv4
22	Dropbear	TCP/IPv4
80	Lighthttpd	TCP/IPv4
8089	Lighthttpd	TCP/IPv4
69	Opentftpd	UDP/IPv4
9090	Asterisk	UDP/IPv4
6060	zero_config	UDP/IPv4
5060	Asterisk	UDP/IPv4
4569	Asterisk	UDP/IPv4
5353	zero_config	UDP/IPv4
37435	Syslogd	UDP/IPv4

For general firewall defense mechanisms, UCM supports Ping Defense, SYN-Flood Defense, and Ping-of-Death Defense. These can be configured separately for the WAN interface and LAN interface.

**Table 12: Typical Firewall Settings**

<b>Ping Defense Enable</b>	If enabled, the UCM will not send ICMP messages in response to ping requests.
<b>SYN-Flood Defense Enable</b>	If enabled, the UCM will limit the amount of SYN packets accepted from one source to 10 packets per second, preventing the UCM web portal from becoming inaccessible. Excess packets will be discarded.  There is no need to mention the WAN and LAN parts since it is already mentioned in sentence before the table.
<b>Ping-of-Death Defense Enable</b>	If enabled, the UCM will not be affected by ping of death attacks.

In the Custom Firewall Settings section, users can create rules to accept, reject, or drop specific traffic going through the UCM. To create a new rule, click on the  button. To be consistent with the rest of the manual, get an image of the actual "Create New Rule" button.

Select the connection type the rule will apply to.



### Create New Firewall Rule

\* Rule Name :

\* Action :

\* Type :



\* Interface :

\* Service :

**Figure 26: Create New Firewall Rule**

**Table 13: Firewall Rule Settings**

<b>Rule Name</b>	Enter a name for the firewall rule.
<b>Action</b>	Select the action for the Firewall to perform. <ul style="list-style-type: none"> <li>• ACCEPT</li> <li>• REJECT</li> <li>• DROP</li> </ul>
<b>Type</b>	Select the traffic type. <ul style="list-style-type: none"> <li>• <b>IN</b> If selected, the Interface field will appear. Users must specify the interface that the inbound rule will be applied to.</li> <li>• <b>OUT</b></li> </ul>
<b>Service</b>	Select the connection type the rule will apply to. <ul style="list-style-type: none"> <li>• FTP</li> <li>• SSH</li> <li>• Telnet</li> <li>• TFTP</li> <li>• HTTP</li> <li>• LDAP</li> <li>• Custom</li> </ul> <p>If selected, users must configure the Source IP and Port, Destination IP Address and Port, and the Protocol fields that appear. If the source and destination are left blank, the "Anywhere" values will be used.</p>

The new rule will be listed at the bottom of the page with sequence number, rule name, action, protocol, type, source, destination and operation. Users can click on  to edit the rule or click on  to delete the rule. The UCM must be rebooted for the new rules to take effect.



## Dynamic Defense

On the Dynamic Defense page, users can configure the UCM to monitor incoming TCP connections and prevent excessive traffic from hosts. The UCM must have "Route" configured in the **System Settings→Network Settings→Basic Settings** page. The blacklist on this page is automatically updated. The following options are available:

**Table 14: UCM6510 Firewall Dynamic Defense**

<b>Dynamic Defense Enable</b>	Toggle dynamic defense on and off. This is disabled by default.
<b>Blacklist Update Interval</b>	Configure the blacklist update time interval (in seconds). The default setting is 120. This defines how long the IP will be blocked once added into the UCM6510 blacklist. For example, if set to "300", blocked IP addresses will not be able to establish TCP connections with the UCM until after 300 seconds have passed.
<b>Connection Threshold</b>	Configure the connection threshold. Once a host exceeds this threshold, it will be added to the blacklist. Default setting is 100. Reviewer Note: the "Periodic Time Interval" option is no longer available.
<b>Dynamic Defense Whitelist</b>	Allowed IPs and ports range, multiple IP addresses and port range. For example: <b>192.168.5.100</b> <b>192.168.5.200 1500:2000</b>

The following figure shows a configuration example like this:

- If a host at IP address 192.168.5.7 initiates more than 20 TCP connections to the UCM6510, it will be added into UCM6510 blacklist.
- This host 192.168.5.7 will be blocked by the UCM6510 for 5000 seconds.
- Since IP range 192.168.5.100-192.168.5.200 is in whitelist, if host initiates more than 20 TCP connections to the UCM6510, it will not be added into UCM6510 blacklist. It can still establish TCP connection with the UCM6510.



### Dynamic Defense

Dynamic Defense Enable:

\* Blacklist Update Interval (s):

\* Connection Threshold:

Dynamic Defense Whitelist:

**Figure 27: Configure Dynamic Defense**

## Fail2ban

Fail2Ban feature on the UCM6510 provides intrusion detection and prevention for authentication errors in SIP REGISTER, INVITE and SUBSCRIBE and prevents SIP brute force attacks on the PBX system. Once an IP address exceeds the allowed number of login or SIP authentication attempts within the configured "Max Retry Duration" period, all SIP and HTTP requests from that IP address will be dropped, forbidding web access and blocking further authentication attempts.



### Security Settings

Static Defense
Dynamic Defense
Fail2ban
TLS Security
SSH Access

**Global Settings**

Enable Fail2Ban:

\* Banned Duration:

\* Max Retry Duration:

\* MaxRetry:

Fail2ban Whitelist:  -

[Add Fail2ban Whitelist](#) +

**Local Settings**

Asterisk Service:

Listening port number:  UDP Port: 5060

\* MaxRetry:

Login Attack Defense:

Listening port number:  TCP Port

\* MaxRetry:

**Blacklist**

BANNED TYPE	IP
No Data	

**Figure 28: Fail2ban Settings**



**Table 15: Fail2Ban Settings**

Global Settings	
<b>Enable Fail2Ban</b>	Enable Fail2Ban. The default setting is disabled. Please make sure both “Enable Fail2Ban” and “Asterisk Service” are turned on to use Fail2Ban for SIP authentication on the UCM6510.
<b>Banned Duration</b>	Configure the duration (in seconds) for the detected host to be banned. The default setting is 600. If set to 0, the host will be always banned.
<b>Max Retry Duration</b>	If a host exceeds the maximum allowed number attempts configured for Max Retry within the configured Max Retry Duration window, the host will be banned. The default setting is 600 seconds.
<b>MaxRetry</b>	Configures the maximum number of allowed authentication failures within the configured Max Retry Duration window. The default setting is 5.
<b>Fail2Ban Whitelist</b>	Configures the IP addresses, CIDR masks, and DNS hosts in the Fail2Ban whitelist. Whitelisted entries will not be banned by Fail2Ban even after exceeding the allowed number of authentication failures. Up to 20 addresses can be added.
Local Settings	
<b>Asterisk Service</b>	Enable Asterisk service for Fail2Ban. The default setting is disabled. Please make sure both “Enable Fail2Ban” and “Asterisk Service” are turned on to use Fail2Ban for SIP authentication on the UCM6510.
<b>Listening Port Number</b>	Configure the listening port number for the service. By default, port 5060 will be used for UDP and TCP, and port 5061 will be used for TLS.
<b>MaxRetry</b>	Configures the maximum number of authentication failures before the host is banned. The default setting is 10. Please note that this will override the <b>Global Settings</b> → <b>MaxRetry</b> setting.
<b>Login Attack Defense</b>	Enables defense against excessive login attacks to the UCM's web GUI. The default setting is disabled.
<b>Listening Port Number</b>	This is the Web GUI listening port number which is configured under <b>System Settings</b> → <b>HTTP Server</b> → <b>Port</b> . The default is 8089.
<b>MaxRetry</b>	Configures the maximum allowed number of failed login attempts from an IP address before it is added to the Fail2Ban blacklist.
Blacklist	
<b>Blacklist</b>	Users will be able to view the IPs that have been blocked by UCM.

## TLS Security

SSH access can be toggled from the UCM's webUI and physical LCD screen. The webUI option can be found under **System Settings**→**Security Settings**-→**SSH Access**. SSH access is disabled by default and should only be turned on for troubleshooting and debugging.





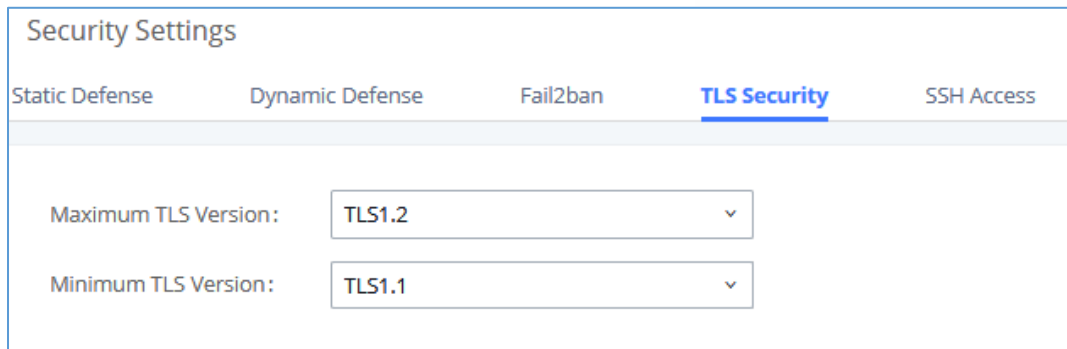


Figure 29: TLS Security

## SSH Access

SSH switch now is available via Web GUI and LCD. User can enable or disable SSH access directly from Web GUI or LCD screen. For web SSH access, please log in UCM6510 web interface and go to **System Settings**→**Security Settings**→**SSH Access**. By default, SSH access is disabled for security concerns. It is highly recommended to only enable SSH access for debugging purpose.

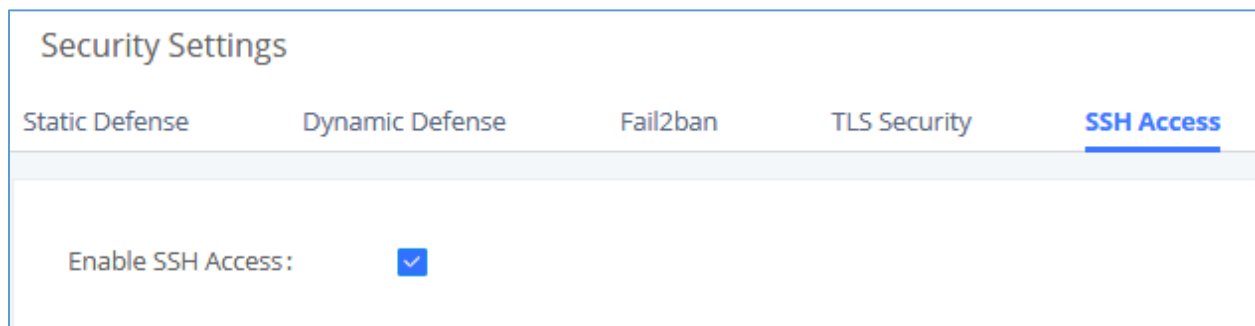


Figure 30: SSH Access

## LDAP Server

The UCM6510 has an embedded LDAP/LDAPS server for users to manage corporate phonebooks in a centralized manner.

- The LDAP server automatically generates an initial phonebook with **PBX DN** "ou=pbx,dc=pbx,dc=com" based on the UCM6510's existing extensions.
- Users could add new phonebook with a different **Phonebook DN** for other external contacts. For example, "ou=people,dc=pbx,dc=com".
- All the phonebooks in the UCM6510 LDAP server have the same **Base DN** "dc=pbx,dc=com".
- "cn" "ou" and "dc" are parts of LDAP data Interchange Format according to RFC2849, which is how the LDAP tree is filtered.

Cn= Common Name



ou= Organization Unit  
 dc= Domain Component

- Here is an example of how the search for “ou=pbx,dc=pbx,dc=com” is performed in LDAP server query. From the dc=com Domain Component, find the dc=pbx Domain Component first. In the dc=pbx Domain Component, find the Organizational Unit called pbx (ou=pbx) and then find the object that has a Common Name of admin.

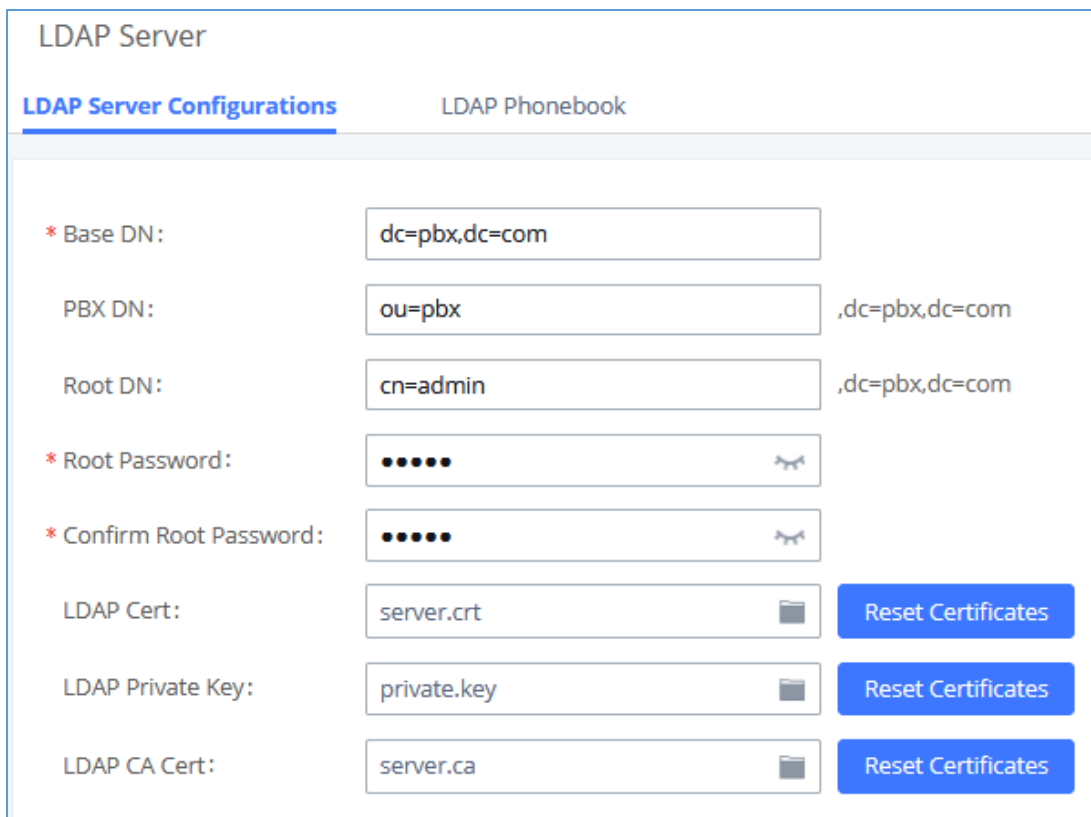
If users have the Grandstream phone provisioned by the UCM6510, the LDAP directory has been set up on the phone and can be used right away for users to access all phonebooks generated in the UCM6510.

Additionally, users could manually configure the LDAP client settings to manipulate the built-in LDAP server on the UCM6510. If the UCM6510 has multiple LDAP phonebooks created, in the LDAP client configuration, users could use “dc=pbx,dc=com” as Base DN to have access to all phonebooks on the UCM6510 LDAP server, or use a specific phonebook DN, for example “ou=people,dc=pbx,dc=com”, to access to phonebook with Phonebook DN “ou=people,dc=pbx,dc=com “ only.

To access LDAP Server settings, go to Web GUI→**System Settings**→**LDAP Server**.

## LDAP Server Configurations


The following figure shows the default LDAP/LDAPS server configurations on the UCM6510.

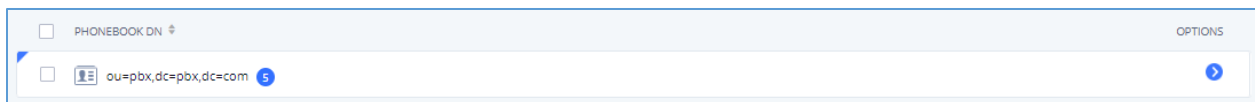


LDAP Server	
LDAP Server Configurations	LDAP Phonebook
* Base DN:	dc=pbx,dc=com
PBX DN:	ou=pbx ,dc=pbx,dc=com
Root DN:	cn=admin ,dc=pbx,dc=com
* Root Password:	•••••
* Confirm Root Password:	•••••
LDAP Cert:	server.crt <span>Reset Certificates</span>
LDAP Private Key:	private.key <span>Reset Certificates</span>
LDAP CA Cert:	server.ca <span>Reset Certificates</span>

Figure 31: LDAP Server Configurations

The UCM6510 LDAP/LDAPS server supports anonymous access (read-only) by default. Therefore, the LDAP client does not have to configure username and password to access the phonebook directory. The “Root DN” and “Root Password” (limited with 64 and 32 characters respectively) here are for LDAP management and configuration where users will need provide for authentication purpose before modifying the LDAP information.













The default phonebook list in this LDAP server can be viewed and edited by clicking on  for the first phonebook under LDAP Phonebook.



**Figure 32: Default LDAP Phonebook DN**

Edit Phonebook: pbx

+ Add Contact

AccountNumber ↕	CallerID Name ↕	Options
1000	John DOE	 
1001		 
1002		 
1003		 
1004		 
1005		 

**Figure 33: Default LDAP Phonebook Attributes**

## LDAP Phonebook

Users could use the default phonebook, edit the default phonebook as well as add new phonebook on the LDAP server. The first phonebook with default phonebook dn “ou=pbx,dc=pbx,dc=com” displayed on the LDAP server page is for extensions in this PBX. Users cannot add or delete contacts directly. The contacts information will need to be modified via Web GUI→**Extension/Trunk**→**Extensions** first. The default LDAP phonebook will then be updated automatically.

LDAP Server Configurations **LDAP Phonebook**

Note: The first phonebook is for extensions in this PBX. The contacts cannot be added or deleted directly. To add or delete the contacts, please modify the accounts in "Extensions" page first. To modify the read-only attributes, please edit the corresponding items in "Extension" page, and the phone book will be automatically updated when the change is saved and applied. Users can add other phonebooks for external accounts. For those phonebooks, users can edit LDAP attributes and add or delete contacts directly.

<input type="checkbox"/>	Phonebook DN ↕	Options
<input type="checkbox"/>	ou=pbx,dc=pbx,dc=com	

**Figure 34: LDAP Server→LDAP Phonebook**

- **Add new phonebook**

A new sibling phonebook of the default PBX phonebook can be added by clicking on “Add” under “LDAP Phonebook” section.



**Add Phonebook** ✕

\* Phonebook Prefix:

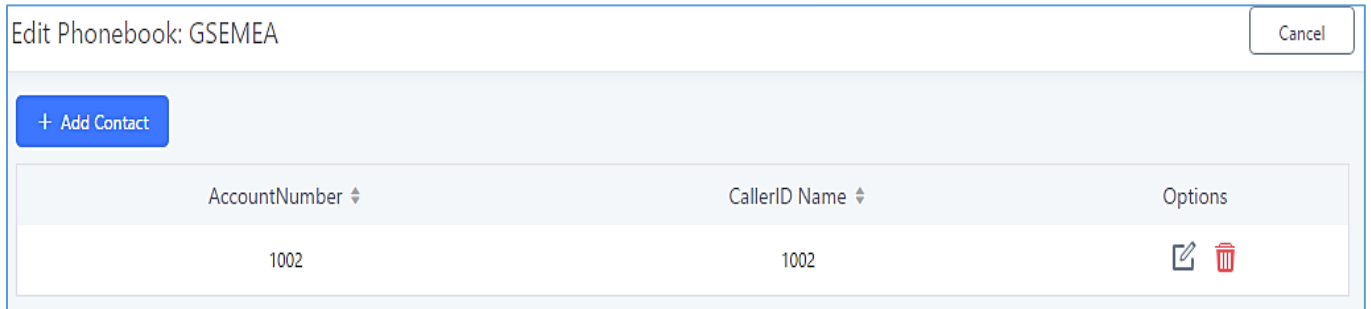
Phonebook DN:

**Figure 35: Add LDAP Phonebook**

Configure the “Phonebook Prefix” first. The “Phonebook DN” will be automatically filled in. For example, if configuring “Phonebook Prefix” as “people”, the “Phonebook DN” will be filled with “ou=people,dc=pbx,dc=com”.

Once added, users can select  to edit the phonebook attributes and contact list (see figure below) or select  to delete the phonebook.

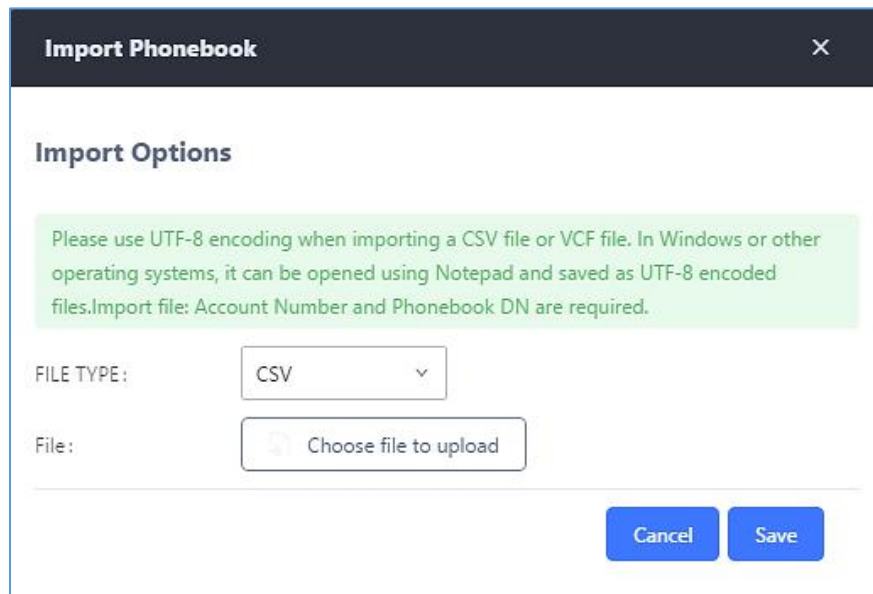




**Figure 36: Edit LDAP Phonebook**

- **Import phonebook from your computer to LDAP server**

Click on “Import Phonebook” and a dialog will prompt as shown in the figure below.



**Figure 37: Import Phonebook**

The file to be imported must be a CSV, VCF or XML file with UTF-8 encoding. Users can open the file with Notepad and save it with UTF-8 encoding.

Here is an example CSV file. Please note “Account Number” and “Phonebook DN” fields are required. Users can export a phonebook file from the UCM's LDAP phonebook section and use it as a template.

	A	B	C	D	E	F	G	H	I	J
1	First Name	Last Name	Account Number	CallerID Name	Email	Department	Mobile Number	Home Number	Fax	Phonebook DN
2	John	Doe	1001	1001		IT	1001000000			phonebook
3	Jane	Doe	1002	1002		Sales	1002000000			phonebook
4	William	Chung	1003	1003		Marketing	1003000000			phonebook
5	Linda	Kuo	1004	1004		Accounting	1004000000			phonebook
6	Steve	Chang	1005	1005		Support	1005000000			others

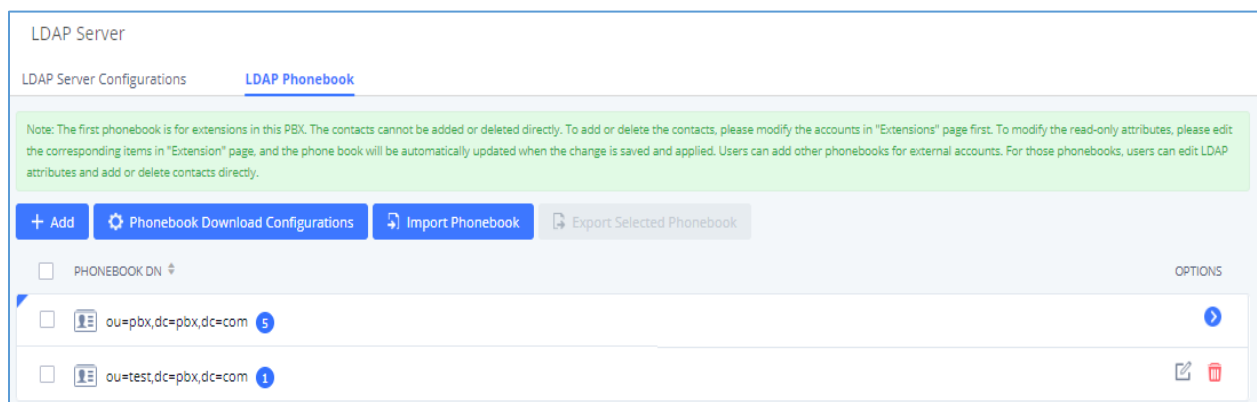
**Figure 38: Phonebook CSV File Format**



The Phonebook DN field is the same “Phonebook Prefix” entry as when the user clicks on “Add” to create a new phonebook. Therefore, if the user enters “phonebook” in “Phonebook DN” field in the CSV file, the actual phonebook DN “ou=phonebook,dc=pbx,dc=com” will be automatically created by the UCM6510 once the CSV file is imported.

In the CSV file, users can specify different phonebook DN fields for different contacts. If the phonebook DN already exists on the UCM6510 LDAP Phonebook, the contacts in the CSV file will be added into the existing phonebook. If the phonebook DN does not exist on the UCM6510 LDAP Phonebook, a new phonebook with this phonebook DN will be created.

The sample phonebook CSV file in above picture will result in the following LDAP phonebook in the UCM6510.

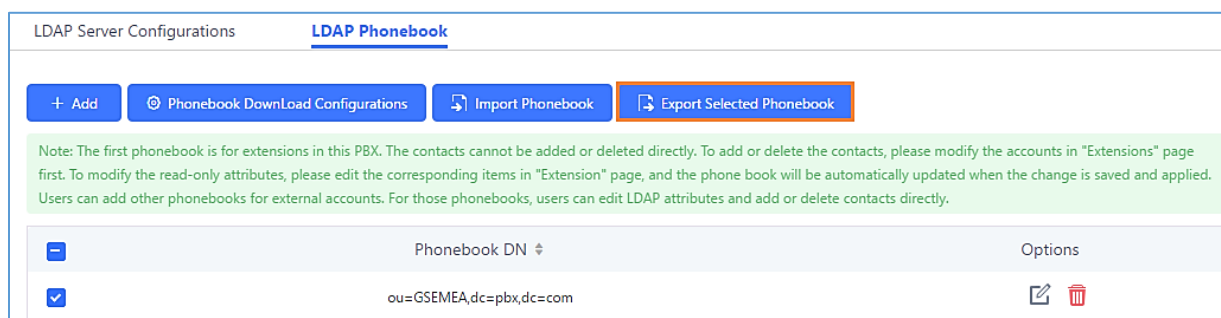


**Figure 39: LDAP Phonebook After Import**

As the default LDAP phonebook with DN “ou=pbx,dc=pbx,dc=com” cannot be edited or deleted in LDAP phonebook section, users cannot import contacts that have "pbx" in the Phonebook DN field of the CSV file.

- **Export phonebook to your computer from UCM6510 LDAP server**

Select the checkbox for the LDAP phonebook and then click on “Export Selected Phonebook” to export the selected phonebook. The exported phonebook can be used as a record or a sample CSV, VFC or XML file for the users to add more contacts in it and import to the UCM6510 again.



**Figure 40: Export Selected LDAP Phonebook**



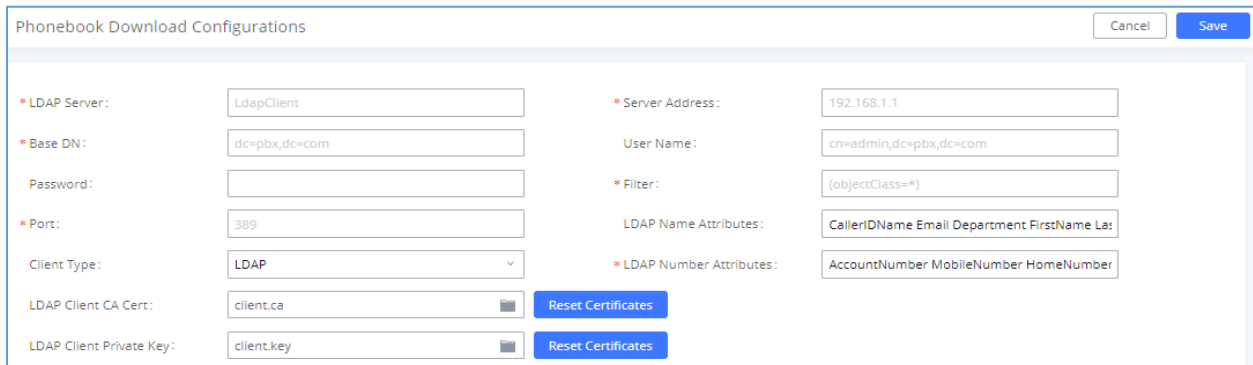
## LDAP Client Configurations

The configuration on LDAP client is useful when you use other LDAP servers. Here we provide an example on how to configure the LDAP client on the UCM.

Assuming the remote server base dn is “**dc=pbx,dc=com**”, configure the LDAP client as follows:

- **LDAP Server:** Enter a name for the remote LDAP server
- **Server Address:** Enter the IP address or domain name for remote LDAP server.
- **Base DN:** dc=pbx,dc=com
- **Username:** Enter username if authentication is required. This field cannot exceed 64 characters and can contain space.
- **Password:** Enter password if authentication is required.
- **Filter:** Enter the filter. Ex: ((CallerIDName=%)(AccountNumber=%))
- **Port:** Enter the port number. Ex:389
- **LDAP Name Attributes:** Enter the name attributes for remote server
- **LDAP Number Attributes:** Enter the number attributes for remote server
- **Client type:** Protocol of LDAP or LDAPS.
- **LDAP Client CA cert:** Upload LDAP client CA certificate, The following file types are supported: .crt .der and .pem.
- **LDAP Client Private Key:** Upload LDAP client private key.

The following figure gives a sample configuration for UCM6510 acting as an LDAP client.



The screenshot shows a dialog box titled "Phonebook Download Configurations" with "Cancel" and "Save" buttons. The configuration fields are as follows:

* LDAP Server:	LdapClient	* Server Address:	192.168.1.1
* Base DN:	dc=pbx,dc=com	User Name:	cn=admin,dc=pbx,dc=com
Password:		* Filter:	{objectClass=*}
* Port:	389	LDAP Name Attributes:	CallerIDName Email Department FirstName Last
Client Type:	LDAP	* LDAP Number Attributes:	AccountNumber MobileNumber HomeNumber
LDAP Client CA Cert:	client.ca		Reset Certificates
LDAP Client Private Key:	client.key		Reset Certificates

**Figure 41: LDAP Client Configurations**

To configure Grandstream IP phones as the LDAP clients for UCM, please refer to the following example:

- **Server Address:** The IP address or domain name of the UCM6510
- **Base DN:** dc=pbx,dc=com
- **Username:** Please leave this field empty



- **Password:** Please leave this field empty
- **LDAP Name Attribute:** CallerIDName Email Department FirstName LastName
- **LDAP Number Attribute:** AccountNumber MobileNumber HomeNumber Fax
- **LDAP Number Filter:** (AccountNumber=%)
- **LDAP Name Filter:** (CallerIDName=%)
- **LDAP Display Name:** AccountNumber CallerIDName
- **LDAP Version:** If existed, please select LDAP Version 3
- **Port:** 389

The following figure shows the configuration information on a Grandstream GXP2170 to successfully use the LDAP server as configured in **[Figure 31: LDAP Server Configurations]**.





## LDAP

LDAP protocol	<input type="text" value="LDAP"/>
Server Address	<input type="text" value="192.168.40.134"/>
Port	<input type="text" value="389"/>
Base	<input type="text" value="dc=pbx,dc=com"/>
User Name	<input type="text"/>
Password	<input type="password"/>
LDAP Number Filter	<input type="text" value="(AccountNumber=%)"/>
LDAP Name Filter	<input type="text" value="(CallerIDName=%)"/>
LDAP Version	<input type="radio"/> Version 2 <input checked="" type="radio"/> Version 3
LDAP Name Attributes	<input type="text" value="CallerIDName"/>
LDAP Number Attributes	<input type="text" value="AccountNumber"/>
LDAP Display Name	<input type="text" value="AccountNumber CallerIDName"/>
Max. Hits	<input type="text" value="50"/>
Search Timeout	<input type="text" value="30"/>
Sort Results	<input checked="" type="radio"/> No <input type="radio"/> Yes
LDAP Lookup	<input checked="" type="checkbox"/> Incoming Calls <input checked="" type="checkbox"/> Outgoing Calls
Lookup Display Name	<input type="text"/>

Figure 42: GXP2170 LDAP Phonebook Configuration

## Time Settings

### Automatic Date and Time

The current system time can be found under **System Status**→**Dashboard** and **System Information**.

To configure the UCM to automatically update time, navigate to **System Settings**→**Time Settings**→**Automatic Date and Time**.



 **Note:**

The configurations under Web GUI→**System Settings**→**Time Settings**→**Automatic Date and Time** page require reboot to take effect. Please consider configuring auto time updating related changes when setting up the UCM6510 for the first time to avoid service interrupt after installation and deployment in production.

**Table 16: Auto Time Updating**

<b>Remote NTP Server</b>	Specify the server address of the NTP server for the UCM6510 to sync date and time with. The default NTP server is pool.ntp.org.
<b>Enable DHCP Option 2</b>	If set to "Yes", the UCM's time zone can be provisioned via DHCP Option 2 from a local server automatically.
<b>Enable DHCP Option 42</b>	If set to "Yes", the UCM's NTP server can be provisioned via DHCP Option 42 from a local server automatically. This will override the manually configured NTP server. The default setting is "Yes".
<b>Time Zone</b>	Select the time zone for the UCM to use. If "Self-Defined Tome Zone" is selected, please specify the time zone parameters in "Self-Defined Time Zone" field as described in below option.
<b>Self-Defined Time Zone</b>	If "Self-Defined Time Zone" is selected in "Time Zone" option, users will need define their own time zone following the format below. The syntax is: std offset dst [offset], start [/time], end [/time] Default is set to: MTZ+6MDT+5,M4.1.0,M11.1.0 <b>MTZ+6MDT+5</b> This indicates a time zone with 6 hours offset and 1 hour ahead for DST, which is U.S central time. If it is positive (+), the local time zone is west of the Prime Meridian (A.K.A: International or Greenwich Meridian); If it is negative (-), the local time zone is east. <b>M4.1.0,M11.1.0</b> The 1 <sup>st</sup> number indicates Month: 1, 2, 3..., 12 (for Jan, Feb...Dec.). The 2 <sup>nd</sup> number indicates the nth iteration of the weekday: (1 <sup>st</sup> Sunday, 3 <sup>rd</sup> Tuesday...). Normally 1, 2, 3, 4 are used. If 5 is used, it means the last iteration of the weekday. The 3 <sup>rd</sup> number indicates weekday: 0, 1, 2...6 (for Sun, Mon, Tues... Sat). Therefore, this example is the DST which starts from the First Sunday of April to the 1 <sup>st</sup> Sunday of November.

## Set Date and Time

To manually set the time on the UCM6510, go to Web GUI→**System Settings**→**Time Settings**→**Set Date**






**and Time.** The format is YYYY-MM-DD HH:MM:SS.


Time Settings

Automatic Date and Time    **Set Date and Time**    NTP Server    Office Time    Holiday

---

Current Date and Time:          

Date Format:     

Time Format:     

**Figure 43: Set Time Manually**

 **Note:**

Manually setup time will take effect immediately after saving and applying change in the Web GUI. If users would like to reboot the UCM6510 and keep the manually setup time setting, please make sure “Remote NTP Server”, “Enable DHCP Option 2” and “Enable DHCP Option 42” options under Web GUI→**System Settings**→**Time Settings**→**Time Auto Updating** page are unchecked or set to empty. Otherwise, time auto updating settings in this page will take effect after reboot.

### **NTP Server**

The UCM can act as an NTP server for clients to sync their system times with. To configure this, navigate to **System Settings**→**Time Settings**→**NTP Server** and set Enable NTP Server to "Yes". On the client side, use the UCM's IP address or hostname as the NTP server address.

### **Office Time**

The system administrator can define office hours which can be used as conditions for call forwarding and inbound routing. To configure this, navigate to **System Settings**→**Time Settings**→**Office Time** and click on the Add button to create office hours.



Menus
☰
Create New Office Time
Save

System Status
Extension / Trunk
Call Features
PBX Settings
System Settings
HTTP Server
Network Settings
OpenVPN
DDNS Settings
Security Settings
LDAP Server
Time Settings
Email Settings
Maintenance
CDR
Value-added Features

Time:  -

Week:  Sun  Mon  Tue  
 Wed  Thu  Fri  
 Sat

Show Advanced Options:

Month:  Jan  Feb  Mar  
 Apr  May  Jun  
 Jul  Aug  Sept  
 Oct  Nov  Dec

Day:  1  2  3  
 4  5  6  
 7  8  9  
 10  11  12  
 13  14  15  
 16  17  18  
 19  20  21  
 22  23  24  
 25  26  27  
 28  29  30  
 31

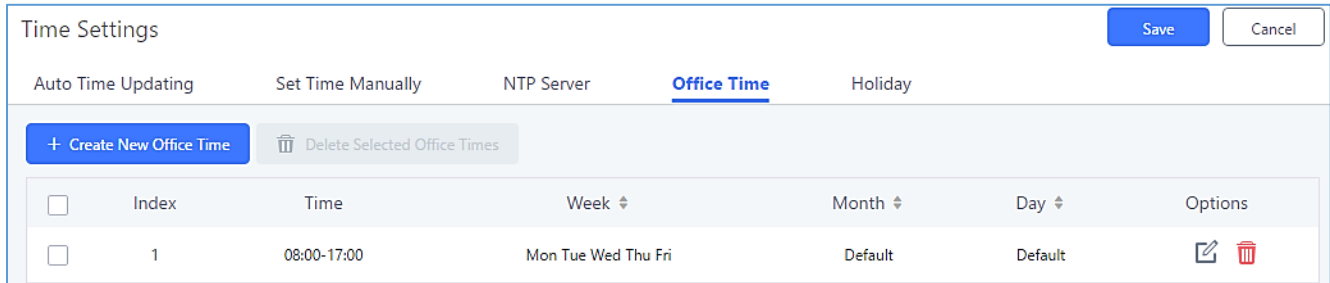
**Figure 44: Create New Office Time**

**Table 17: Create New Office Time**

<b>Start Time</b>	Configure the start time for office hour.
<b>End Time</b>	Configure the end time for office hour
<b>Week</b>	Select the workdays in one week.
<b>Show Advanced Options</b>	Check this option to show advanced options. Once selected, please specify “Month” and “Day” below.
<b>Month</b>	Select the months for office time.
<b>Day</b>	Select the workdays in one month.





Select “Start Time”, “End Time” and the day for the “Week” for the office time. The system administrator can also define month and day of the month as advanced options. Once done, click on “Save” and then “Apply Change” for the office time to take effect. The office time will be listed in the web page as the figure shows below.





Time Settings Save Cancel

Auto Time Updating Set Time Manually NTP Server Office Time Holiday

+ Create New Office Time Delete Selected Office Times

<input type="checkbox"/>	Index	Time	Week ↕	Month ↕	Day ↕	Options
<input type="checkbox"/>	1	08:00-17:00	Mon Tue Wed Thu Fri	Default	Default	 

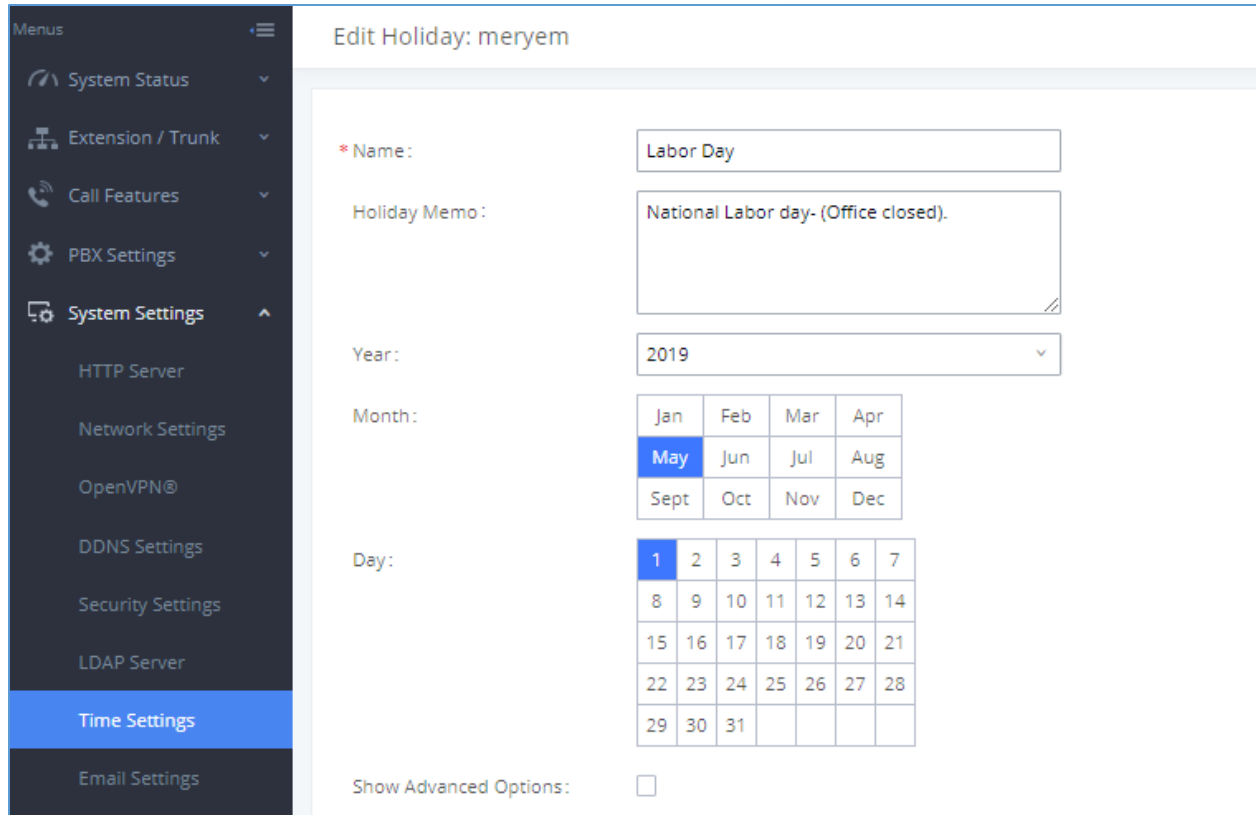
**Figure 45: System Settings→Time Settings→Office Time**

- Click on  to edit the office time.
- Click on  to delete the office time.
- Click on “Delete Selected Office Times” to delete multiple selected office times at once.

## Holiday

System administrators can define holidays which can be used as conditions for call forwarding and inbound routing. To configure this, navigate to **System Settings→Time Settings→Holiday** and click on the Add button to create a new holiday.





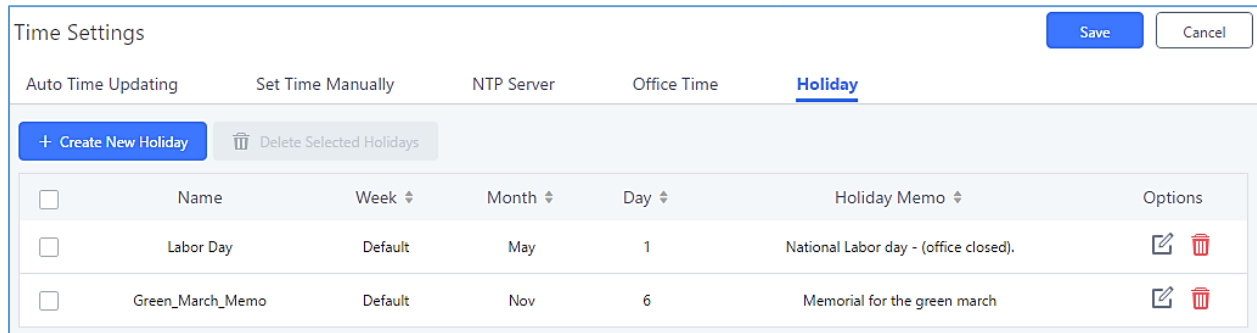
**Figure 46: Create New Holiday**

**Table 18: Create New Holiday**



<b>Name</b>	Specify the holiday name to identify this holiday.
<b>Holiday Memo</b>	Create a note for the holiday.
<b>Year</b>	Select the year of the Holiday. <b>Note:</b> Users can configure holidays for the next 4 years.
<b>Month</b>	Select the month for the holiday.
<b>Day</b>	Select the day for the holiday.
<b>Show Advanced Options</b>	Check this option to show advanced options. If selected, please specify the days as holiday in one week below.
<b>Week</b>	Select the days as holiday in one week.

Enter holiday “Name” and “Holiday Memo” for the new holiday. Then select “Month” and “Day”. The system administrator can also define days in one week as advanced options. Once done, click on “Save” and then “Apply Change” for the holiday to take effect. The holiday will be listed in the web page as the figure shows below.





**Figure 47: System Settings→Time Settings→Holiday**

- Click on  to edit the holiday.
- Click on  to delete the holiday.
- Click on “Delete Selected Holidays” to delete multiple selected holidays at once.

 **Note:**

For more details on how to use office time and holiday, please refer to the link below:

[http://www.grandstream.com/sites/default/files/Resources/office\\_time\\_and\\_holiday\\_on\\_ucm6xxx.pdf](http://www.grandstream.com/sites/default/files/Resources/office_time_and_holiday_on_ucm6xxx.pdf)

## Email Settings

### Email Settings

The UCM's email module can send out alert event emails, fax (Fax-to-Email), voicemail (Voicemail-to-Email), etc. Email settings can be configured in **System Settings→Email Settings**.

**Table 19: Email Settings**

<b>TLS Enable</b>	Enable or disable TLS during transferring/submitted your email to another SMTP server. The default setting is “Yes”.
<b>Type</b>	<ul style="list-style-type: none"> <li>• <b>MTA:</b> Mail Transfer Agent. UCM will act as a virtual mail server, and emails will be sent from the configured domain. There is no need to configure SMTP server settings, and no credentials will be required. However, emails sent using MTA may be considered as spam by destination SMTP servers.</li> <li>• <b>Client:</b> UCM will send emails to the configured SMTP server to forward to the final destination. Credentials for the SMTP server will be required.</li> </ul>



<b>Domain</b>	Specify the domain name to be used in the Email when using type "MTA".
<b>Server</b>	Specify the SMTP server when using type "Client". For example, if using Gmail as the SMTP server, you can configure it as <i>smtp.gmail.com:465</i> .
<b>Username</b>	Username is required when using type "Client". This is typically the email address.
<b>Password</b>	Password for the entered <b>Username</b> .
<b>Enable Email-to-Fax</b>	<p>Toggles the Email-to-Fax feature.</p> <p>If enabled, the UCM will monitor the configured email inbox (using provided [Username] and [Password]) for emails with the subject "<b>SendFaxMail To XXX</b>". Example : SendFaxMail To 7200</p> <p>The UCM will extract the attachments of detected emails and send it to the <b>XXX</b> extension by fax.</p> <p>The attachment must be in PDF/TIF/TIFF format.</p> <p><b>Note:</b> This field will appear when using Type "Client".</p>
<b>Email-to-Fax Blacklist/Whitelist</b>	Enables Email-to-Fax Blacklist/Whitelist functionality.
<b>Email-to-Fax Subject</b>	Specify the Email subject format for fax sending, the subject can be either " <b>SendFaxMail To XXX</b> " or " <b>XXX</b> " with XXX the fax number.
<b>Internal Blacklist/Whitelist</b>	Specify the Email address blacklist/whitelist for local extensions. This feature prevents faxing from unauthorized email addresses. The internal list includes only contacts with local extensions
<b>External Blacklist/Whitelist</b>	<p>Specify the Email address blacklist/whitelist for non-local contacts. This feature prevents faxing from unauthorized email addresses. The external list is for non-local contacts.</p> <p><b>Note:</b> Multiple addresses can be separated with semicolon (;) i.e. "<b>XXX;YYY</b>".</p>
<b>POP/POP3 Server Address</b>	Configure the POP/POP3 server address for the configured username Example: pop.gmail.com
<b>POP/POP3 Server Port</b>	Configure the POP/POP3 server port for the configured username Example: 995
<b>Display Name</b>	Specify the display name in the FROM header in the Email.
<b>Sender</b>	Specify the sender's Email address. For example: pbx@example.mycompany.com.





The following figure shows example email settings, where 192.168.6.202 is the SMTP server.

### Email Settings

Email Settings
Email Template
Email Send Log

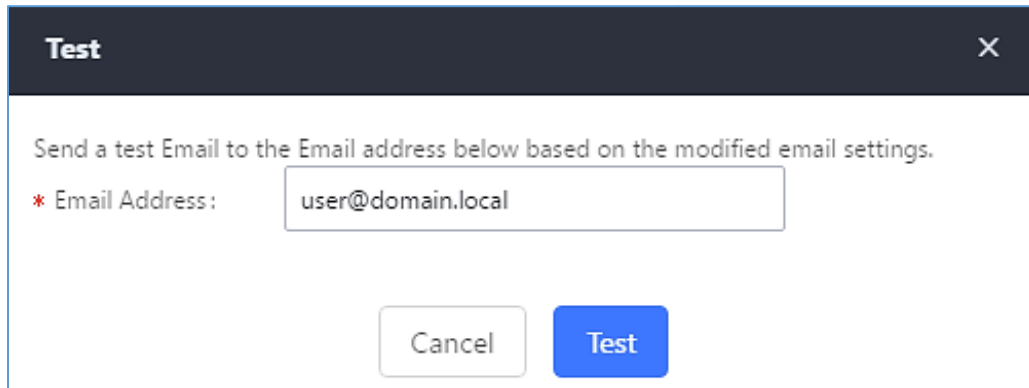
TLS Enable :	<input checked="" type="checkbox"/>
Type :	<input type="text" value="Client"/>
Email Template Sending	<input type="text" value="HTML"/>
Format :	
* SMTP Server :	<input type="text" value="192.168.6.202:587"/>
* Enable SASL Authentication :	<input checked="" type="checkbox"/>
* Username :	<input type="text" value="adminSntp"/>
* Password :	<input type="password" value="....."/>
Enable Email-to-Fax :	<input checked="" type="checkbox"/>
Email-to-Fax	<input type="text" value="Disable"/>
Blacklist/Whitelist :	
Email-to-Fax Subject	<input type="text" value="XXX"/>
Format :	
* POP/POP3 Server Address :	<input type="text" value="192.168.6.202"/>
* POP/POP3 Server Port :	<input type="text" value="991"/>
* Display Name :	<input type="text" value="Branch_PBX"/>
* Sender :	<input type="text" value="Branch1@domain.local"/>

**Figure 48: UCM6510 Email Settings**

Once configuration is complete, click on the Save button first and then the Test button to verify that the settings work.



The following figure shows the new dialog prompted to test the Email setting. Fill in a valid Email address to send a test Email to verify the Email settings on the UCM6510.




**Figure 49: UCM6510 Email Settings: Send Test Email**

## Email Templates

The UCM provides various email templates for different email notifications. Email templates can be accessed from **System Settings**→**Email Settings**→**Email Templates**.


Email Settings			
Email Settings		<a href="#">Email Template</a>	Email Send Log
<a href="#">Upload Template Images</a> <a href="#">Reset All Template Images</a>			
TYPE	NAME	TIME	OPTIONS
Alert Events	alert_template.html	2019-11-14 15:20:52 UTC-05:00	
PMS	pms_template.html	2019-11-14 15:20:52 UTC-05:00	
Emergency Calls	emergency_template.html	2019-11-14 15:20:52 UTC-05:00	
Extension	account_template.html	2019-11-14 15:20:52 UTC-05:00	
Fax	fax_template.html	2019-11-14 15:20:52 UTC-05:00	
Video Conference	mcm_template.html	2019-11-14 15:20:52 UTC-05:00	
Conference Report	conferencereport_template.html	2019-11-14 15:20:52 UTC-05:00	
Call Queue Statistics	callqueestatics_template.html	2019-11-14 15:20:52 UTC-05:00	
Fax Sending	sendfax_template.html	2019-11-14 15:20:52 UTC-05:00	
CDR	cdr_template.html	2019-11-14 15:20:52 UTC-05:00	
Missed Calls	missedcall_template.html	2019-11-14 15:20:52 UTC-05:00	
Voicemail	voicemail_template.html	2019-11-14 15:20:52 UTC-05:00	
User Password	password_template.html	2019-11-14 15:20:52 UTC-05:00	
Conference Schedule	conference_template.html	2019-11-14 15:20:52 UTC-05:00	

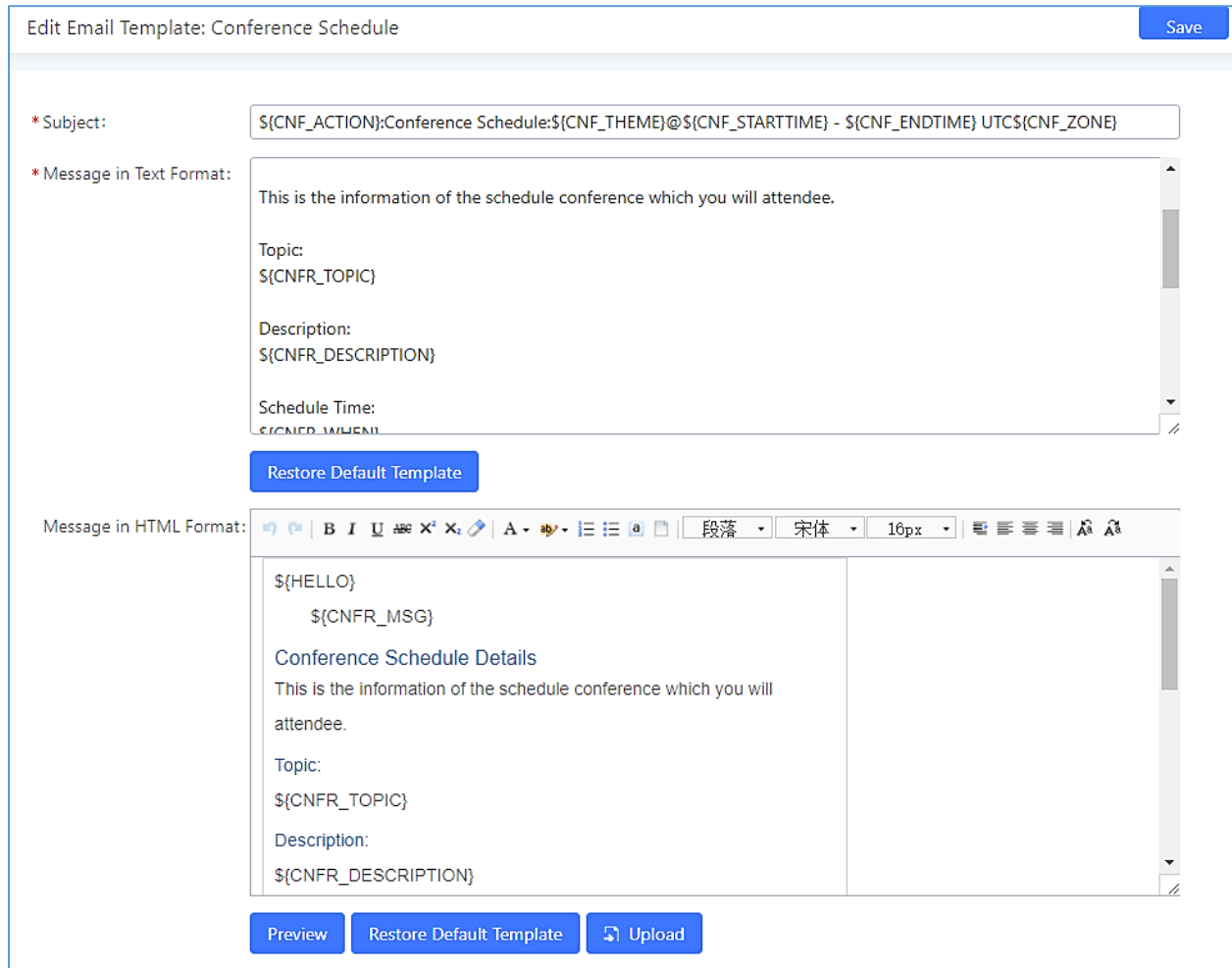
**Figure 50: Email Templates**

Press on  to upload pictures to be used on email templates.



Press [Reset all template pictures](#) to reset all email templates to default ones.

To configure the email template, simply click the  button under Options column, and edit the template as desired.



**Figure 51: Conference Schedule Template**

- Users can preview mail sample by clicking on [Preview](#).
- Click on [Restore Default Template](#) to restore the default email template.
- Finally, users can click on [Upload](#) to upload a custom picture to the email template to display their own logo in the sent mails for example



## Email Send Log

Under UCM Web GUI→**System Settings**→**Email Settings**→**Email Send Log**, users could search, filter and check whether the Email is sent out successfully or not. This page will also display the corresponding error message if the Email is not sent out successfully.

Email Settings

Email Settings    Email Template    Email Send Log

---

Email Send Log Filter

Show All Logs    Delete All Logs

**250** Mail sent successfully.  
**501** Address format parsing error. In MTA mode, If the recipient's email address contains unsupported characters, a 501 message will be returned. Please check if the format of the recipient's email address is correct. In Client mode, some servers also return 501 when the sender and mail accounts do not match. Please correct "Sender" for your "Mail Account".  
**535** There was a problem with account/password verification in client mode. Please check that "account and password" are configured correctly.  
**550** Possible Causes: (1)The recipient's email address does not exist or is in a disabled state. Please check the recipient's email address for errors.  
 (2)The number of destination addresses sent by the sender exceeds the maximum daily limit and is temporarily blacklisted. Please decrease the sending frequency or try again the next day.  
 (3)The sending IP does not pass the SPF permission detection of the sending domain. Messages sent in MTA mode may still return the error code even if they are sent successfully.  
**552** The message size is too large, or the message attachment type is disabled.  
**553** Sender and mail account inconsistencies. Please configure the "Sender" for your "Mail Account".  
**554** The message is identified as spam. Please decrease the sending frequency or retry the next day.  
**none** Means no return code. If the "sending result" is deferred, there may be a problem with the mail server configuration, Please check to see if the "server" configuration is correct. If the result is bounced, there may be a problem with the domain name of the recipient's email address. Please check the message's "recipient" to make sure it is correct. If in MTA mode, please make sure that "Domain" is configured to be in the same domain as the recipient.

In MTA mode, you cannot receive SPF authentication. Therefore, even if mail is sent successfully, the return code of 550 will still be returned. Many mail servers will place non-SPF-certified mail into the trash or quarantine mailbox. If the recipient has not received sent mail, please check to see if the sent mail was placed in the recipient's trash or quarantine mailbox.

In Client mode, a 250 return code means that the Email has been sent successfully from the UCM to your proxy mail server. The Email still fails to be sent due to invalid destination address or other reasons. Please login in your configuration mail account and check whether there is System bounce notification to confirm the cause of the failure.

**Figure 52: Email Send log**

**Table 20: Email Log**

Field	Description
<b>Start Time</b>	Enter the start time for filter
<b>End Time</b>	Enter the end time for filter
<b>Receivers</b>	Enter the email recipient, while searching for multiple recipients, please separate then with comma and no spaces.
<b>Send Result</b>	Enter the status of the send result to filter with
<b>Return Code</b>	Enter the email code to filter with
<b>Email Send Module</b>	Select the email module to filter with from the drop-down list, which contains: <ul style="list-style-type: none"> <li>• All Modules</li> <li>• Extension</li> <li>• Voicemail</li> <li>• Conference Schedule</li> </ul>



- Emergency calls
- Video conference Schedule
- User Password
- Alert Events
- CDR
- Fax
- Fax sending
- Call Queue Statistics
- Conference Reports
- PMS
- Test
- Missed calls

Email logs will be shown on bottom of “Email Send Log” page, as shown on the following figure.



Email Generated Time	Email Send Module	Receivers	Last Send Time	Last Send Address	Send Result	Return Code	Options
2017-05-03 03:43:16	Test	mbaomar@grandstream.com	05-03 03:43:18	mbaomar@grandstream.com	sent	250	
2017-05-03 03:43:10	Test	mbaomar@grandstream.com	05-03 03:43:13	mbaomar@grandstream.com	sent	250	

Figure 53: Email Logs

## Recordings Storage

The UCM supports both automatic and manual call recordings. Recordings can be saved to UCM's local storage, external storage (SD/USB disks), and NAS.

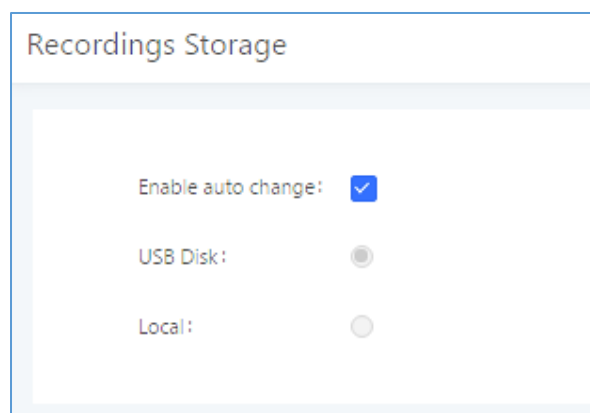


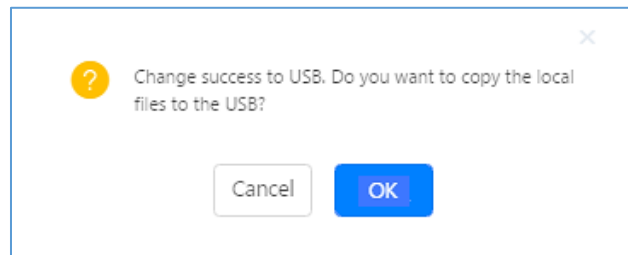
Figure 54: PBX Settings→Recordings Storage

- If “**Enable Auto Change**” is selected, the recording storage location will automatically change to NAS, USB Disk, or SD card if they are available. If all storage location types are available, the priority will be NAS->USB Disk->SD Card->Local storage.



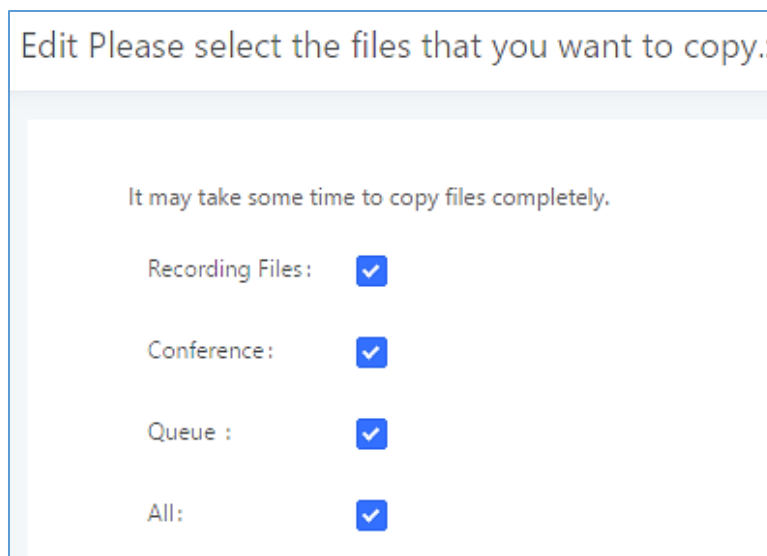
- If **“Local”** is selected, the recordings will be stored in UCM6510 internal storage.
- If **“USB Disk”** or **“SD Card”** is selected, the recordings will be stored in the corresponding plugged in external storage device. Please note the options “USB Disk” and “SD Card” will be displayed only if they are plugged into the UCM6510.

Once “USB Disk” or “SD Card” is selected, click on “OK”. The user will be prompted to confirm to copy the local files to the external storage device.



**Figure 55: Recordings Storage Prompt Information**

Click on “OK” to continue. The users will be prompted a new dialog to select the categories for the files to be copied over.



**Figure 56: Recording Storage Category**

On the UCM6510, recording files are generated and exist in 3 categories: normal call recording files, conference recording files, and call queue recording files. Therefore, users have the following options when select the categories to copy the files to the external device:

- **Recording Files:** Copy the normal recording files to the external device.
- **Conference:** Copy the conference recording files to the external device.
- **Queue:** Copy the call queue recording files to the external device.
- **All:** Copy all recording files to the external device.



# PROVISIONING

## Overview

Grandstream SIP Devices can be configured via Web interface as well as via configuration file through TFTP/HTTP/HTTPS download. All Grandstream SIP devices support a proprietary binary format configuration file and XML format configuration file. The UCM6510 provides a Plug and Play mechanism to auto-provision the Grandstream SIP devices in a zero-configuration manner by generating XML config file and having the phone to download it within LAN area. This allows users to finish the installation with ease and properly manage SIP devices.

To provision a phone, three steps are involved, i.e., discovery, configuration and provisioning. This section explains how Zero Config works on the UCM6510. The settings for this feature can be accessed via Web GUI → **Value-added Features** → **Zero Config**.

## Configuration Architecture for End Point Device

The end point device configuration in Zero Config is divided into the following three layers with priority from the lowest to the highest:

- **Global**

This is the lowest layer. Users can configure the most basic options that could apply to all Grandstream SIP devices during provisioning via Zero Config.

- **Model**

In this layer, users can define model-specific options for the configuration template.

- **Device**

This is the highest layer. Users can configure device-specific options for the configuration for individual device here.

Each layer also has its own structure in different levels. Please see figure below. The details for each layer are explained in sections **[Global Configuration]**, **[Model Configuration]** and **[Device Configuration]**.



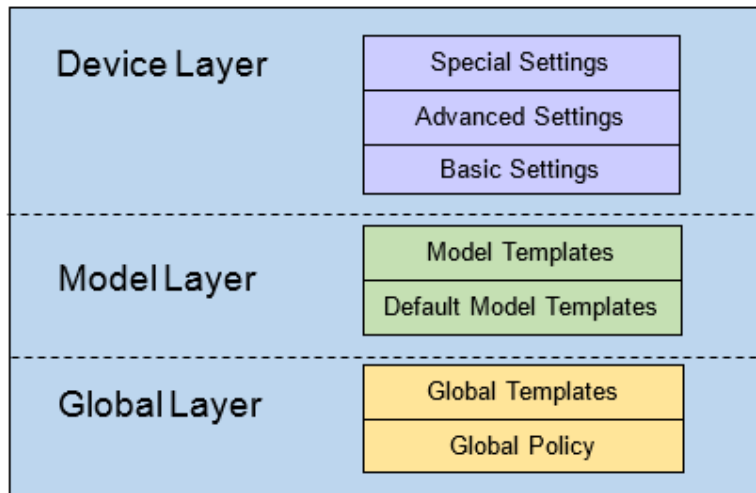


Figure 57: Zero Config Configuration Architecture for End Point Device

The configuration in model layer and device layer have all the options in global layers already, i.e., the options in global layer is a subset of the options in model layer and device layer. If an option is set in all three layers with different values, the highest layer value will override the value in lower layer. For example, if the user selects English for Language setting in Global Policy and Spanish for Language setting in Default Model Template, the language setting on the device to be provisioned will use Spanish as model layer has higher priority than global layer. To sum up, **configurations in higher layer will always override the configurations for the same options/fields in the lower layer when presented at the same time.**

After understanding the Zero Config configuration architecture, users could configure the available options for end point devices to be provisioned by the UCM6510 by going through the three layers. This configuration architecture allows users to set up and manage the Grandstream end point devices in the same LAN area in a centralized way.

## Auto Provisioning Settings

By default, the Zero Config feature is enabled on the UCM6510 for auto provisioning. Two methods of auto provisioning are used.





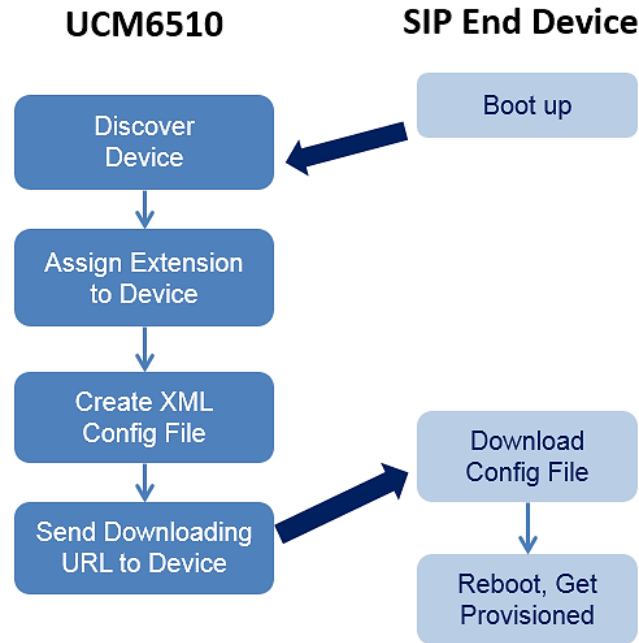


Figure 58: UCM6510 Zero Config

- **SIP SUBSCRIBE**

When the phone boots up, it sends out SUBSCRIBE to a multicast IP address in the LAN. The UCM6510 discovers it and then sends a NOTIFY with the XML config file URL in the message body. The phone will then use the path to download the config file generated in the UCM6510 and take the new configuration.

- **DHCP OPTION 66**

This method should be used only when the UCM6510 is set to “Route” mode under Web GUI→**System Settings**→**Network Settings**→**Basic Settings**: Method. When the phone restarts (by default DHCP Option 66 is turned on), it will send out a DHCP DISCOVER request. The UCM6510 receives it and returns DHCP OFFER with the config server path URL in the Option 66, for example, <https://192.168.2.1:8089/zccgi/>. The phone will then use the path to download the config file generated in the UCM6510.

To start the auto provisioning process, under Web GUI→**Value-added Features**→**Zero Config**→**Zero Config Settings**, fill in the auto provision information.



Zero Config

[Zero Config](#)   [Global Policy](#)   [Global Templates](#)   [Model Templates](#)   [Model Update](#)   [Zero Config Settings](#)

---

**Basic Settings**

Enable Zero Config:

Enable Automatic Configura...

**Extension Assignment**

Auto provision automatically provides an extension to the device.  
 There are two methods of auto provision: SIP SUBSCRIBE and DHCP Option 66.

For example, when the device boots up, it will send SIP SUBSCRIBE multicast in the LAN. The PBX will find it, create an account and return a URL of the config file for the device to download.

Auto Assign Extension:

Zero Config Extension Segm...5000 - 6299   [Zero Config Extension Segment](#)

Enable Pick Extension:

Pick Extension Segment: 4000 - 4999   [Pick Extension Segment](#)

Pick Extension Period (hour)...

**Network Settings**

Subnet Whitelist:  +

[Save](#)

**Figure 59: Auto Provision Settings**

**Table 21: Auto Provision Settings**

<b>Enable Zero Config</b>	Enable or disable the Zero Config feature on the PBX. The default setting is enabled.
<b>Enable Automatic Configuration Assignment</b>	<p>By default, this is disabled. If disabled, when SIP device boots up, the UCM6510 will only send the configuration path to the device when you have any manual configuration on the device. This manual configuration includes:</p> <ul style="list-style-type: none"> <li>Any configuration under BASIC and CUSTOM page of the device in Zero Config page</li> <li>If any global or model template (except for the default template) is selected for the assigned device in Zero Config page.</li> </ul> <p><b>Note:</b> When disabled, SIP devices can still be provisioned by manually sending NOTIFY from the UCM6510 which will include the XML config file URL for the SIP device to download.</p>



<b>Auto Assign Extension</b>	If enabled, when the device is discovered, the PBX will automatically assign an extension within the range defined in “Zero Config Extension Segment” to the device. The default setting is disabled.
<b>Zero Config Extension Segment</b>	Click on the link “Zero Config Extension Segment” to specify the extension range to be assigned if “Automatically Assign Extension” is enabled. The default range is 5000-6299. Zero Config Extension Segment range can be defined in Web GUI→ <b>PBX Settings</b> → <b>General Settings</b> page→Extension Preference section: “Auto Provision Extensions”.
<b>Enable Pick Extension</b>	If enabled, the extension list will be sent out to the device after receiving the device’s request. This feature is for the GXP series phones that support selecting extension to be provisioned via phone’s LCD. The default setting is disabled.
<b>Pick Extension Segment</b>	Click on the link “Pick Extension Segment” to specify the extension list to be sent to the device. The default range is 4000 to 4999. Pick Extension Segment range can be defined in Web GUI→ <b>PBX Settings</b> → <b>General Settings</b> → <b>General</b> page→Extension Preference section: “Pick Extensions”.
<b>Pick Extension Period (hour)</b>	Specify the number of minutes to allow the phones being provisioned to pick extensions.
<b>Subnet Whitelist</b>	<p>This feature allows the UCM to provision devices in different subnets other than UCM network.</p> <p>Enter subnets IP addresses to allow devices within these subnets to be provisioned. The syntax is <b>&lt;IP&gt;/&lt;CIDR&gt;</b>.</p> <p><u>Examples:</u></p> <p>10.0.0.1/8</p> <p>192.168.6.0/24</p> <p><b>Note:</b> Only private IP ranges (10.0.0.0   172.16.0.0   192.168.0.0) are supported.</p>

Please make sure an extension is manually assigned to the phone or “Automatically Assign Extension” is enabled during provisioning. After the configuration on the UCM6510 Web GUI, click on “Save” and “Apply Changes”. Once the phone boots up and picks up the config file from the UCM6510 it will immediately apply the configuration.

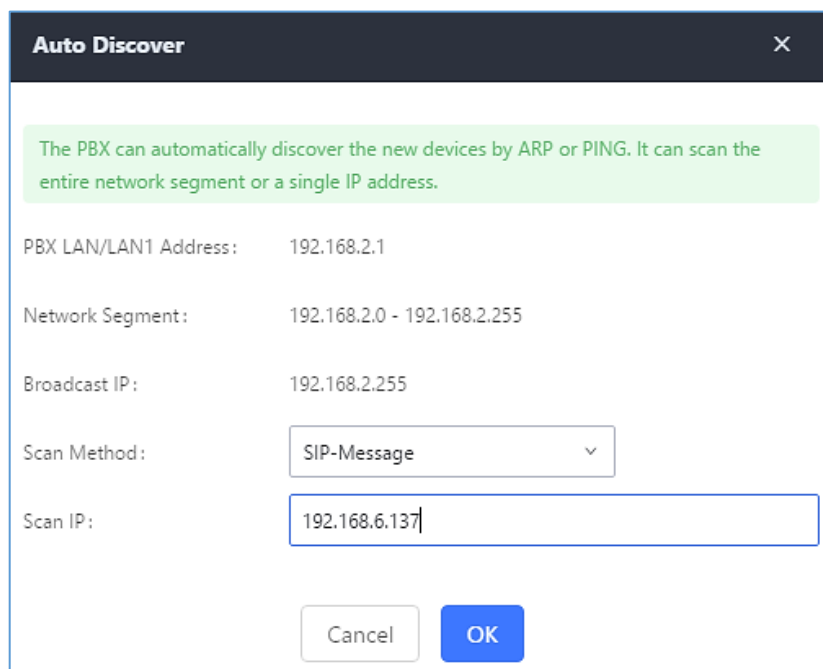
## Discovery

Grandstream endpoints are automatically discovered after bootup. Users could also manually discover device by specifying the IP address or scanning the entire LAN network. Three methods are supported to scan the devices.



- PING
- ARP
- SIP Message (NOTIFY)

Click on “Auto Discover” under Web GUI→**Value-added Features**→**Zero Config**→**Zero Config**, fill in the “Scan Method” and “Scan IP”. The IP address segment will be automatically filled in based on the network mask detected on the UCM6510. If users need scan the entire network segment, enter 255 (for example, 192.168.5.255) instead of a specific IP address. Then click on “Save” to start discovering the devices within the same network. To successfully discover the devices, “Zero Config” needs to be enabled on the UCM6510 Web GUI→**Value-added Features**→**Zero Config**→**Auto Provisioning Settings**.



**Auto Discover** [X]

The PBX can automatically discover the new devices by ARP or PING. It can scan the entire network segment or a single IP address.

PBX LAN/LAN1 Address: 192.168.2.1

Network Segment: 192.168.2.0 - 192.168.2.255

Broadcast IP: 192.168.2.255

Scan Method: SIP-Message

Scan IP: 192.168.6.137

Cancel OK

**Figure 60: Auto Discover**

The following figure shows a list of discovered phones. The MAC address, IP Address, Extension (if assigned), Version, Vendor, Model, Connection Status, Create Config, Options Edit /Delete /Update /Reboot /Access Device WebGUI) are displayed in the list.

Auto Discover can also search for devices located on other subnets, in condition for the subnet to be added under **Zero Config Settings** → **Subnet Whitelist**. The method allowed to auto discover other subnets then the UCM’s is **SIP-Message** like shown below.

**Auto Discover** ✕

The PBX can automatically discover new devices via ARP, PING or SIP Message by scanning the entire network segment or a single IP address.

PBX LAN/LAN1 Address: 192.168.2.1

Network Segment: 192.168.2.0 - 192.168.2.255

Broadcast IP: 192.168.2.255

Scan Method:

Subnet Whitelist:

Scan IP:  -  -  -

**Figure 61: Auto Discover other subnets**

<input type="checkbox"/>	MAC Address ↕	IP Address ↕	Extension	Version ↕	Vendor ↕	Model ↕	Create Config ↕	Options
<input type="checkbox"/>	0008825C6926	192.168.2.104	--	1.0.9.17	GRANDSTREAM	GXP2160	--	    
<input type="checkbox"/>	000882836616	192.168.6.175	--	1.0.9.14	GRANDSTREAM	GXP2160	--	    
<input type="checkbox"/>	000882866015	192.168.2.101	--	1.0.9.11	GRANDSTREAM	GXP2170	--	    
<input type="checkbox"/>	000882A206D8	192.168.6.241	--	1.0.8.50	GRANDSTREAM	GXP2160	--	    
<input type="checkbox"/>	00088275C8B8	192.168.6.137	--	1.0.8.50	GRANDSTREAM	GXP2130	--	    

**Figure 62: Discovered Devices**

## Uploading Devices List

Besides the built-in discovery method on the UCM, users could prepare a list of devices on .CSV file and upload it by clicking on the button Choose File to Upload, after which a success message prompt should be displayed.

Users need to make sure that the CSV file respects the format as shown on the following figure and that the entered information is correct (valid IP address, valid MAC address, device model, version, account..etc.), otherwise the UCM will reject the file and the operation will fail:

1	mac	model	ip	version	account
2	000b82227fb7	GXV3240	192.168.2.103	1.0.3.132	1008
3	000B825C6928	GXP2160	192.168.2.110	1.0.9.135	1000

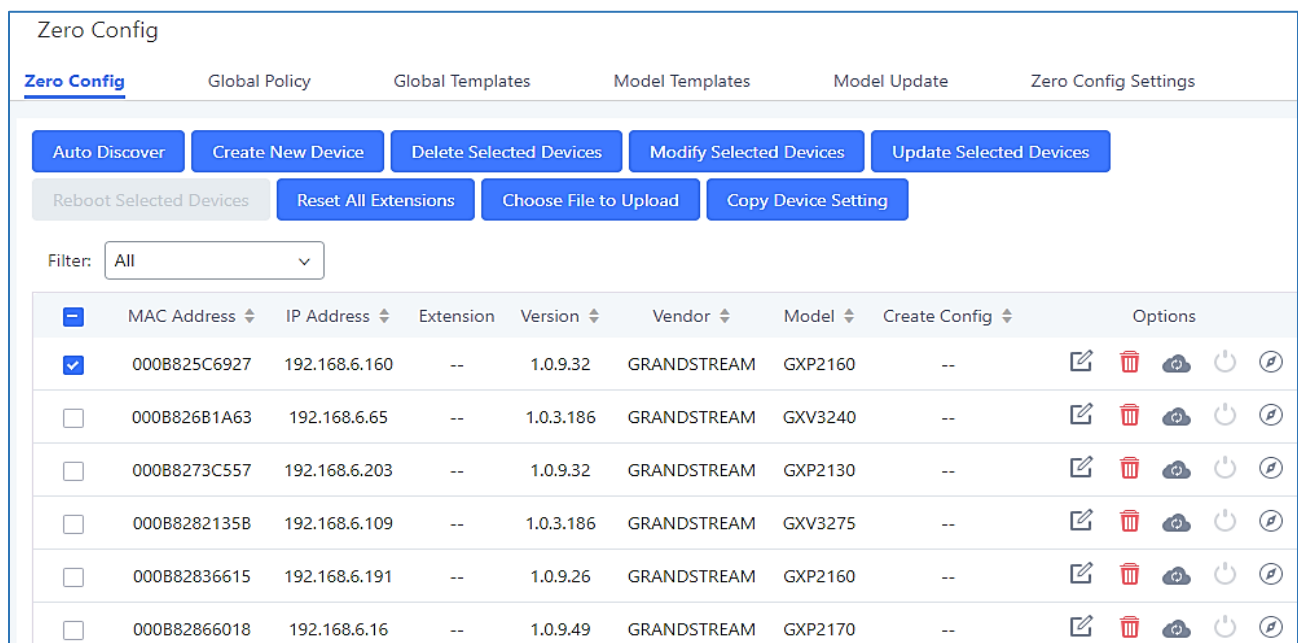
**Figure 63: Device list - CSV file sample**



## Managing discovered devices

- **Sorting:** Press ▲ or ▼ to sort per MAC Address, IP Address, Version, Vendor, Model or Create Config columns from lower to higher or higher to lower respectively.

- **Filter:** Select a filter  to display corresponding results.
  - **All:** Display all discovered devices.
  - **Scan Results:** Display only manually discovered devices. [Discovery]
  - **IP Address:** Enter device IP and press **Search** button.
  - **MAC Address:** Enter device MAC and press **Search** button.
  - **Model:** Enter a model name and press **Search** button. Example: GXP2130.



Zero Config

[Zero Config](#) Global Policy Global Templates Model Templates Model Update Zero Config Settings

[Auto Discover](#)
[Create New Device](#)
[Delete Selected Devices](#)
[Modify Selected Devices](#)
[Update Selected Devices](#)

[Reboot Selected Devices](#)
[Reset All Extensions](#)
[Choose File to Upload](#)
[Copy Device Setting](#)

Filter:

	MAC Address	IP Address	Extension	Version	Vendor	Model	Create Config	Options				
<input checked="" type="checkbox"/>	000B825C6927	192.168.6.160	--	1.0.9.32	GRANDSTREAM	GXP2160	--					
<input type="checkbox"/>	000B826B1A63	192.168.6.65	--	1.0.3.186	GRANDSTREAM	GXV3240	--					
<input type="checkbox"/>	000B8273C557	192.168.6.203	--	1.0.9.32	GRANDSTREAM	GXP2130	--					
<input type="checkbox"/>	000B8282135B	192.168.6.109	--	1.0.3.186	GRANDSTREAM	GXV3275	--					
<input type="checkbox"/>	000B82836615	192.168.6.191	--	1.0.9.26	GRANDSTREAM	GXP2160	--					
<input type="checkbox"/>	000B82866018	192.168.6.16	--	1.0.9.49	GRANDSTREAM	GXP2170	--					

Figure 64: Managing Discovered Devices

From the main menu of zero config, users can perform the following operations:

- Click on [Auto Discover](#) in order to access to the discovery menu as shown on [Discovery] section.
- Click on [Create New Device](#) to add a new device to zero config database using its MAC address.
- Click on [Delete Selected Devices](#) to delete selected devices from the zero-config database.
- Click on [Modify Selected Devices](#) to modify selected devices.
- Click on [Update Selected Devices](#) to batch update a list of devices, the UCM on this case will send SIP NOTIFY message to all selected devices to update them at once.



- Click on **Reboot Selected Devices** to reboot selected devices (the selected devices, should have been provisioned with extensions since the phone will authenticate the server which is trying to send it reboot command).
- Click on **Reset All Extensions** to clear all devices configurations.
- Click on **Choose File to Upload** to upload CSV file containing list of devices.
- Click on **Copy Device Setting** to copy configuration from one device to another. This can be useful for easily replace devices and note that this feature works only between devices of same model.

All these operations will be detailed on the next sections.

## Global Configuration

### Global Policy

Global configuration will apply to all the connected Grandstream SIP end point devices in the same LAN with the UCM6510 no matter what the Grandstream device model it is. It is divided into two levels:

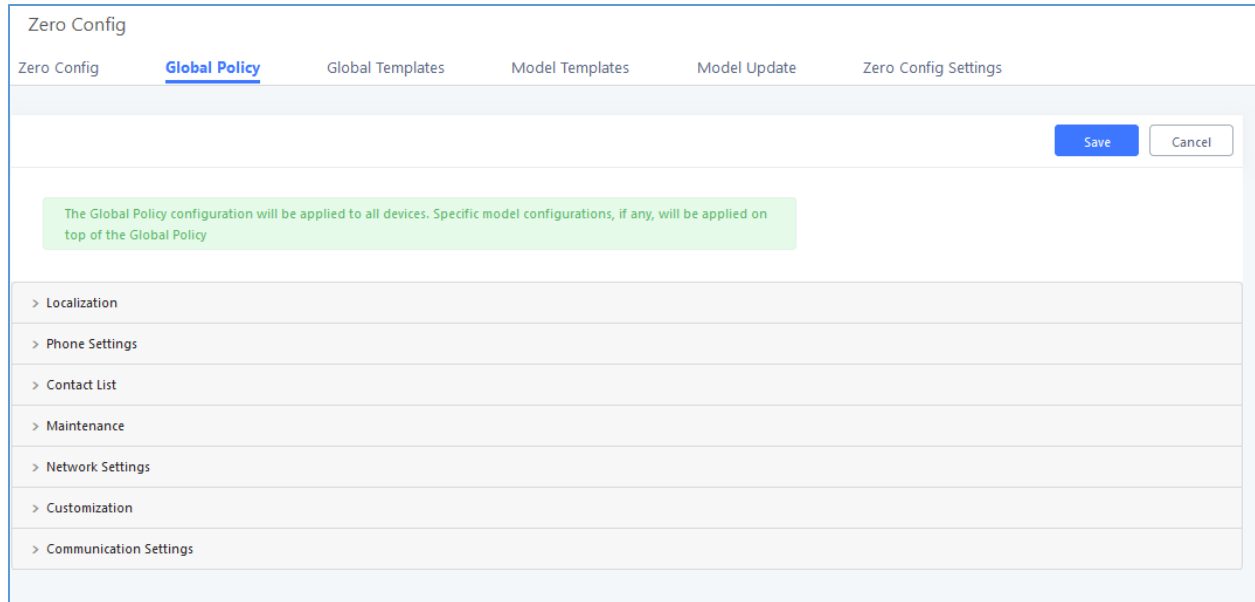
- Web GUI→**Value-added Features**→**Zero Config**→**Global Policy**
- Web GUI→**Value-added Features**→**Zero Config**→**Global Templates**.
- **Global Templates** configuration has higher priority to **Global Policy** configuration.

Global Policy can be accessed in Web GUI→**Value-added Features**→**Zero Config**→**Global Policy** page. On the top of the configuration table, users can select category in the “Options” dropdown list to quickly navigate to the category. The categories are:

- **Localization**: configure display language, data and time.
- **Phone Settings**: configure dial plan, call features, NAT, call progress tones and etc.
- **Contact List**: configure LDAP and XML phonebook download.
- **Maintenance**: configure upgrading, web access, Telnet/SSH access and syslog.
- **Network Settings**: configure IP address, QoS and STUN settings.
- **Customization**: customize LCD screen wallpaper for the supported models.
- **Communication Settings**: configure Email and FTP settings

Select the checkbox on the left of the parameter you would like to configure to activate the dropdown list for this parameter.





**Figure 65: Global Policy Categories**

The following tables list the Global Policy configuration parameters for the SIP end device.

**Table 22: Global Policy Parameters – Localization**

Language settings	
<b>Language</b>	Select the LCD display language on the SIP end device.
Date and Time	
<b>Date Format</b>	Configure the date display format on the SIP end device's LCD.
<b>Time Format</b>	Configure the time display in 12-hour or 24-hour format on the SIP end device's LCD.
<b>NTP Server</b>	Configure the URL or IP address of the NTP server. The SIP end device may obtain the date and time from the server.
<b>Time Zone</b>	Configure the time zone used on the SIP end device.

**Table 23: Global Policy Parameters – Phone Settings**

Default Call Settings	
<b>Dial Plan</b>	Configure the default dial plan rule. For syntax and examples, please refer to user manual of the SIP devices to be provisioned for more details.
<b>Enable Call Features</b>	When enabled, "Do Not Disturb", "Call Forward" and other call features can be used via the local feature code on the phone. Otherwise, the ITSP feature code will be used.
<b>Use # as Dial Key</b>	If set to "Yes", pressing the number key "#" will immediately dial out the input digits.





<b>Auto Answer by Call-info</b>	If set to “Yes”, the phone will automatically turn on the speaker phone to answer incoming calls after a short reminding beep, based on the SIP Call-Info header sent from the server/proxy. The default setting is enabled.
<b>NAT Traversal</b>	Configure if NAT traversal mechanism is activated.
<b>User Random Port</b>	If set to “Yes”, this parameter will force random generation of both the local SIP and RTP ports.
<b>General Settings</b>	
<b>Call Progress Tones</b>	Configure call progress tones including ring tone, dial tone, second dial tone, message waiting tone, ring back tone, call waiting tone, busy tone and reorder tone using the following syntax: f1=val, [f2=val,] c=on1/ off1[- on2/ off2[- on3/ off3]]; <ul style="list-style-type: none"> <li>Frequencies are in Hz and cadence on and off are in 10ms).</li> <li>“on” is the period (in ms) of ringing while “off” is the period of silence. Up to three cadences are supported.</li> <li>Please refer to user manual of the SIP devices to be provisioned for more details</li> </ul>
<b>HEADSET Key Mode</b>	Select “Default Mode” or “Toggle Headset/Speaker” for the Headset key. Please refer to user manual of the SIP devices to be provisioned for more details.

**Table 24: Global Policy Parameters – Contact List**

<b>LDAP Phonebook</b>	
<b>Source</b>	Select “Manual” or “PBX” as the LDAP configuration source. <ul style="list-style-type: none"> <li>If “Manual” is selected, the LDAP configuration below will be applied to the SIP end device.</li> <li>If “PBX” is selected, the LDAP configuration built-in from UCM6510 Web GUI→<b>System Settings</b>→<b>LDAP Server</b> will be applied.</li> </ul>
<b>Address</b>	Configure the IP address or DNS name of the LDAP server.
<b>Port</b>	Configure the LDAP server port. The default value is 389.
<b>Base DN</b>	This is the location in the directory where the search is requested to begin. Example: <ul style="list-style-type: none"> <li>dc=grandstream, dc=com</li> <li>ou=Boston, dc=grandstream, dc=com</li> </ul>
<b>Username</b>	Configure the bind “Username” for querying LDAP servers. The field can be left blank if the LDAP server allows anonymous binds.
<b>Password</b>	Configure the bind “Password” for querying LDAP servers. The field can be left blank if the LDAP server allows anonymous binds.



<b>Number Filter</b>	Configure the filter used for number lookups. Please refer to user manual for more details.
<b>Name Filter</b>	Configure the filter used for name lookups. Please refer to user manual for more details.
<b>Version</b>	Select the protocol version for the phone to send the bind requests. The default value is 3.
<b>Name Attribute</b>	Specify the “name” attributes of each record which are returned in the LDAP search result. Example: <ul style="list-style-type: none"> <li>• gn</li> <li>• cn sn description</li> </ul>
<b>Number Attribute</b>	Specify the “number” attributes of each record which are returned in the LDAP search result. Example: <ul style="list-style-type: none"> <li>• telephoneNumber</li> <li>• telephoneNumber Mobile</li> </ul>
<b>Display Name</b>	Configure the entry information to be shown on phone’s LCD. Up to 3 fields can be displayed. Example: <ul style="list-style-type: none"> <li>• %cn %sn %telephoneNumber</li> </ul>
<b>Max Hits</b>	Specify the maximum number of results to be returned by the LDAP server. Valid range is 1 to 3000. The default value is 50.
<b>Search Timeout</b>	Specify the interval (in seconds) for the server to process the request and client waits for server to return. Valid range is 0 to 180. Default value is 30.
<b>Sort Results</b>	Specify whether the searching result is sorted or not. Default setting is No.
<b>Incoming Calls</b>	Configure to enable LDAP number searching when receiving calls. The default setting is No.
<b>Outgoing Calls</b>	Configure to enable LDAP number searching when making calls. The default setting is No.
<b>Lookup Display Name</b>	Configures the display name when LDAP looks up the name for incoming call or outgoing call. It must be a subset of the LDAP Name Attributes.
<b>XML Phonebook</b>	
<b>Phonebook XML Server</b>	Select the source of the phonebook XML server. <ul style="list-style-type: none"> <li>• <b>Disable</b> Disable phonebook XML downloading.</li> </ul>



	<ul style="list-style-type: none"> <li>• <b>Manual</b> Once selected, users need specify downloading protocol HTTP, HTTPS or TFTP and the server path to download the phonebook XML file. The server path could be IP address or URL, with up to 256 characters.</li> <li>• <b>Local UCM Server</b> Once selected, click on the Server Path field to upload the phonebook XML file. Please note after uploading the phonebook XML file to the server, the original file name will be used as the directory name and the file will be renamed as phonebook.xml under that directory.</li> </ul>
<b>Phonebook Download Interval</b>	Configure the phonebook download interval (in Minute). If set to 0, automatic download will be disabled. Valid range is 5 to 720.
<b>Remove manually edited entries on download</b>	If set to “Yes”, when XML phonebook is downloaded, manually added entries will be removed.

**Table 25: Global Policy Parameters – Maintenance**

Upgrade and Provision	
<b>Firmware Source</b>	<p>UCM can provision the firmware source to devices. The following options are available:</p> <ul style="list-style-type: none"> <li>• <b>URL</b> If selected, complete the configuration for the following four parameters: “Upgrade Via”, “Server Path”, “File Prefix” and “File Postfix”.</li> <li>• <b>Local UCM Server</b> Firmware can be uploaded to the UCM6510 internal storage for firmware upgrade. If selected, click on “Manage Storage” icon next to “Directory” option, upload firmware file and select directory for the end device to retrieve the firmware file.</li> <li>• <b>Local USB Media</b> If selected, the USB storage device needs to be plugged into the UCM6510 and the firmware file must be put under a folder named “ZC_firmware” in the USB storage root directory.</li> <li>• <b>Local SD Card Media</b> If selected, an SD card needs to be plugged into the UCM6510 and the firmware file must be put under a folder named “ZC_firmware” in the USB storage root directory.</li> </ul>
<b>Upgrade via</b>	When URL is selected as firmware source, configure upgrade via TFTP, HTTP or HTTPS.



<b>Server Path</b>	When URL is selected as firmware source, configure the firmware upgrading server path.
<b>File Prefix</b>	When URL is selected as firmware source, configure the firmware file prefix. If configured, only the firmware with the matching encrypted prefix will be downloaded and flashed into the phone, if URL is selected as firmware source.
<b>File Postfix</b>	When URL is selected as firmware source, configure the firmware file postfix. If configured, only the configuration file with the matching encrypted postfix will be downloaded and flashed into the phone.
<b>Allow DHCP Option 43/66</b>	If DHCP option 43 or 66 is enabled on the LAN side, the TFTP server can be redirected.
<b>Automatic Upgrade</b>	<p>If enabled, the end point device will automatically upgrade if a new firmware is detected. Users can select automatic upgrading by day, by week or by minute.</p> <ul style="list-style-type: none"> <li>• <b>By week</b> Once selected, specify the day of the week to check HTTP/TFTP server for firmware upgrades or configuration files changes.</li> <li>• <b>By day</b> Once selected, specify the hour of the day to check the HTTP/TFTP server for firmware upgrades or configuration files changes.</li> <li>• <b>By minute</b> Once selected, specify the interval <b>X</b> that the SIP end device will request for new firmware every <b>X</b> minutes.</li> </ul>
<b>Firmware Upgrade Rule</b>	Specifies how firmware upgrade and provision requests will be sent.
<b>Web Access</b>	
<b>Admin Password</b>	Configure the administrator password for admin level login.
<b>End-User Password</b>	Configure the end-user password for the end user level login.
<b>Web Access Mode</b>	Select HTTP or HTTPS as the web access protocol.
<b>Web Server Port</b>	Configure the port for web access. The valid range is 1 to 65535.
<b>Security</b>	
<b>Disable Telnet/SSH</b>	Enable Telnet/SSH access for the SIP end device. If the SIP end device supports Telnet access, this option controls the Telnet access of the device; if the SIP end device supports SSH access, this option controls the SSH access of the device.
<b>Syslog</b>	
<b>Syslog Server</b>	Configure the URL/IP address for the syslog server.
<b>Syslog Level</b>	Select the level of logging for syslog.
<b>Send SIP Log</b>	Configures whether SIP messages will be included in the syslog.



**Table 26: Global Policy Parameters – Network Settings**

Basic Settings	
<b>IP Address</b>	<p>Configures how the SIP endpoint will obtain IP addresses. The following options are available:</p> <ul style="list-style-type: none"> <li>• <b>DHCP</b> Once selected, users can specify the Host Name (option 12) of the SIP end device as DHCP client, and Vendor Playlist ID (option 60) used by the client and server to exchange vendor playlist ID information.</li> <li>• <b>PPPoE</b> Once selected, users need specify the Account ID, Password and Service Name for PPPoE.</li> </ul>
Advanced Setting	
<b>Layer 3 QoS</b>	Define the Layer 3 QoS parameter. This value is used for IP Precedence, Diff-Serv or MPLS. Valid range is 0-63.
<b>Layer 2 QoS Tag</b>	Assign the VLAN Tag of the Layer 2 QoS packets. Valid range is 0 -4095.
<b>Layer 2 QoS Priority Value</b>	Assign the priority value of the Layer 2 QoS packets. Valid range is 0-7.
<b>STUN Server</b>	Configure the IP address or Domain name of the STUN server. Only non-symmetric NAT routers work with STUN.
<b>Keep Alive Interval</b>	Specify how often the phone will send a blank UDP packet to the SIP server to keep the “ping hole” on the NAT router to open. Valid range is 10-160.

**Table 27: Global Policy Parameters – Customization**

Wallpaper	
<b>Screen Resolution 1024 x 600</b>	<p>Check this option if the SIP endpoint uses a 1024x600 resolution wallpaper.</p> <ul style="list-style-type: none"> <li>• <b>Source</b> Configure the location where wallpapers are stored.</li> <li>• <b>File</b> If “URL” is selected as source, specify the URL of the wallpaper file. If “Local UCM Server” is selected as source, click to upload wallpaper file to the UCM6510.</li> </ul>
<b>Screen Resolution 800 x 400</b>	<p>Check this option if the SIP endpoint uses a 800x400 resolution wallpaper.</p> <ul style="list-style-type: none"> <li>• <b>Source</b> Configure the location where wallpapers are stored.</li> <li>• <b>File</b> If “URL” is selected as source, specify the URL of the wallpaper file. If “Local UCM Server” is selected as source, click to upload wallpaper file to the UCM6510.</li> </ul>
<b>Screen Resolution 480 x 272</b>	<p>Check this option if the SIP endpoint uses a 320x240 resolution wallpaper.</p> <ul style="list-style-type: none"> <li>• <b>Source</b></li> </ul>



	<p>Configure the location where wallpapers are stored.</p> <ul style="list-style-type: none"> <li>• <b>File</b> If “URL” is selected as source, specify the URL of the wallpaper file. If “Local UCM Server” is selected as source, click to upload wallpaper file to the UCM6510.</li> </ul>
<b>Screen Resolution 320 x 240</b>	<p>Check this option if the SIP endpoint uses a 320x240 resolution wallpaper.</p> <ul style="list-style-type: none"> <li>• <b>Source</b> Configure the location where wallpapers are stored.</li> <li>• <b>File</b> If “URL” is selected as source, specify the URL of the wallpaper file. If “Local UCM Server” is selected as source, click to upload wallpaper file to the UCM6510.</li> </ul>

**Table 28: Global Policy Parameters – Communication Settings**

Email Settings	
<b>SMTP Settings</b>	<p>Check this option to configure the email settings that will be sent to the provisioned phones:</p> <ul style="list-style-type: none"> <li>• <b>Server</b> IP address of the SMTP server</li> <li>• <b>Port</b> SMTP server port</li> <li>• <b>From E-Mail address</b> Email address</li> <li>• <b>Sender Username</b> Username of the sender</li> <li>• <b>Password Recovery Email</b> Email where recovered password will be sent</li> <li>• <b>Alarm receive Email 1</b> Email address where alarms notifications will be sent</li> <li>• <b>Alarm receive Email 1</b> Email address where alarms notifications will be sent</li> <li>• <b>Enable SSL</b> Enable SSL protocol for SMTP</li> </ul>
FTP	
<b>FTP</b>	<p>Check this option to configure the FTP settings that will be sent to the provisioned phones:</p>



	<ul style="list-style-type: none"> <li>• <b>Storage Server Type</b> Either FTP or Central Storage</li> <li>• <b>Server</b> FTP server address</li> <li>• <b>Port</b> FTP port to be used</li> <li>• <b>Username</b> FTP username</li> <li>• <b>Path</b> FTP Directory path</li> </ul>
--	---

## Global Templates

Global Templates can be accessed in Web GUI→**Value-added Features**→**Zero Config**→**Global Templates**. Users can create multiple global templates with different sets of configurations and save the templates. Later on, when the user configures the device in Edit Device dialog→Advanced Settings, the user can select to use one of the global templates for the device. Please refer to section [Manage Devices] for more details on using the global templates.

When creating global template, users can select the categories and the parameters under each category to be used in the template. The global policy and the selected global template will both take effect when generating the config file. However, the selected global template has higher priority to the global policy when it comes to the same setting option/field. If the same option/field has different value configured in the global policy and the selected global template, the value for this option/field in the selected global template will override the value in global policy.

- Click on “Create New Template” to add a global template. Users will see the following configurations.

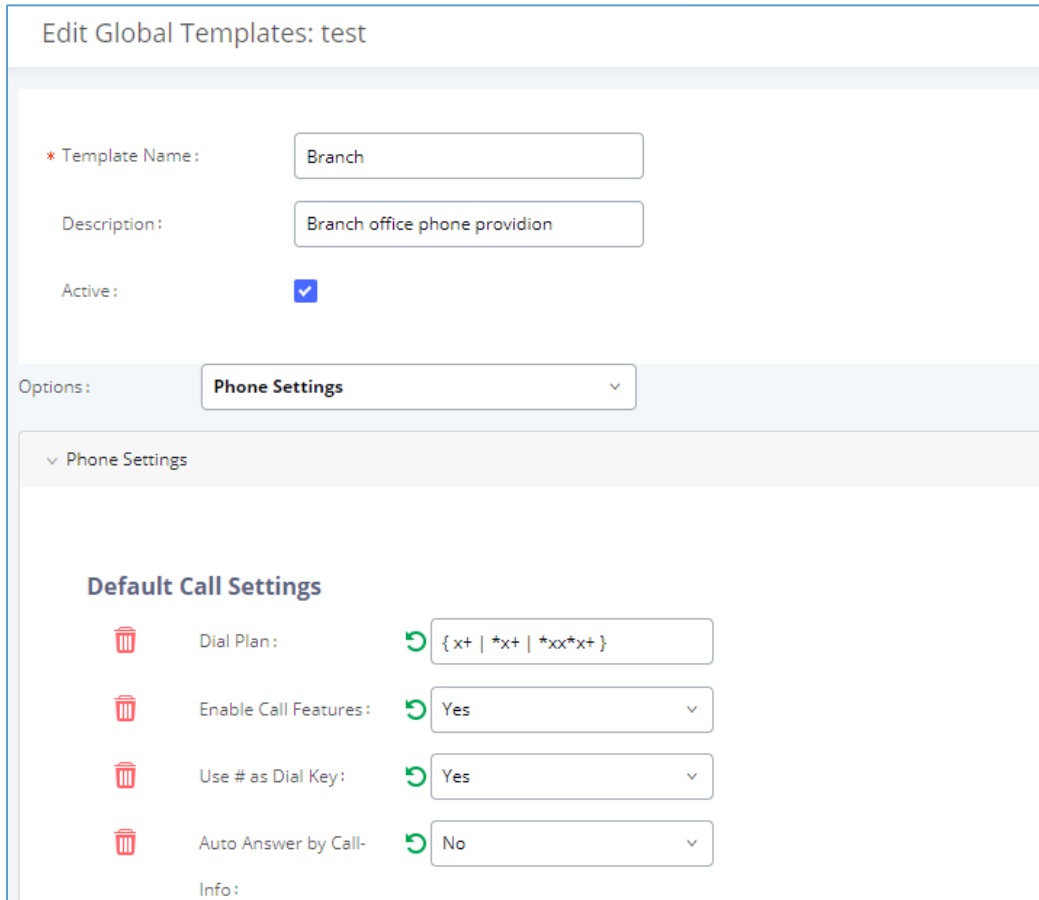
**Table 29: Create New Template**

<b>Template Name</b>	Create a name to identify this global template.
<b>Description</b>	Provide a description for the global template. This is optional.
<b>Active</b>	Check this option to enable the global template.

- Click on  to edit the global template.



The window for editing global template is shown in the following figure. In the “Options” field, after entering the option name key word, the options containing the key word will be listed. Users could then select the options to be modified and click on “Add Option” to add it into the global template.



**Edit Global Templates: test**

\* Template Name:









Description:

Active:

Options:



▼ Phone Settings


**Default Call Settings**

	Dial Plan:		<input data-bbox="716 932 992 974" type="text" value="{x+   *x+   *xx*x+}"/>
	Enable Call Features:		<input data-bbox="716 1001 992 1043" type="text" value="Yes"/>
	Use # as Dial Key:		<input data-bbox="716 1064 992 1106" type="text" value="Yes"/>
	Auto Answer by Call-		<input data-bbox="716 1127 992 1169" type="text" value="No"/>

Info:

**Figure 66: Edit Global Template**

The added options will show in the list. Users can then enter or select value for each option to be used in the global template. On the left side of each added option, users can click on  to remove this option from the template. On the right side of each option, users can click on  to reset the option value to the default value.

- Click on “Save” to save this global template.
- The created global templates will show in the Web GUI→**Value-added Features**→**Zero Config**→**Global Templates** page. Users can click on  to delete the global template or click on “Delete Selected Templates” to delete multiple selected templates at once.





- Click on “Toggle Selected Template(s)” to toggle the status between enabled/disabled for the selected templates.

## Model Configuration

### Model Templates

Model layer configuration allows users to apply model-specific configurations to different devices. Users could create/edit/delete a model template by accessing Web GUI, page **Value-added Features→Zero Config→Model Templates**. If multiple model templates are created and enabled, when the user configures the device in Edit Device dialog→Advanced Settings, the user can select to use one of the model templates for the device. Please refer to section **Manage Devices** for more details on using the model template.

For each created model template, users can assign it as default model template. If assigned as default model template, the values in this model template will be applied to all the devices of this model. There is always only one default model template that can be assigned at one time on the UCM6510.

The selected model template and the default model template will both take effect when generating the config file for the device. However, the model template has higher priority to default model template when it comes to the same setting option/field. If the same option/field has different value configured in the default model template and the selected model template, the value for this option/field in the selected model template will override the value in default model template.

- Click on “Create New Template” to add a model template.



**Table 30: Create New Model Template**

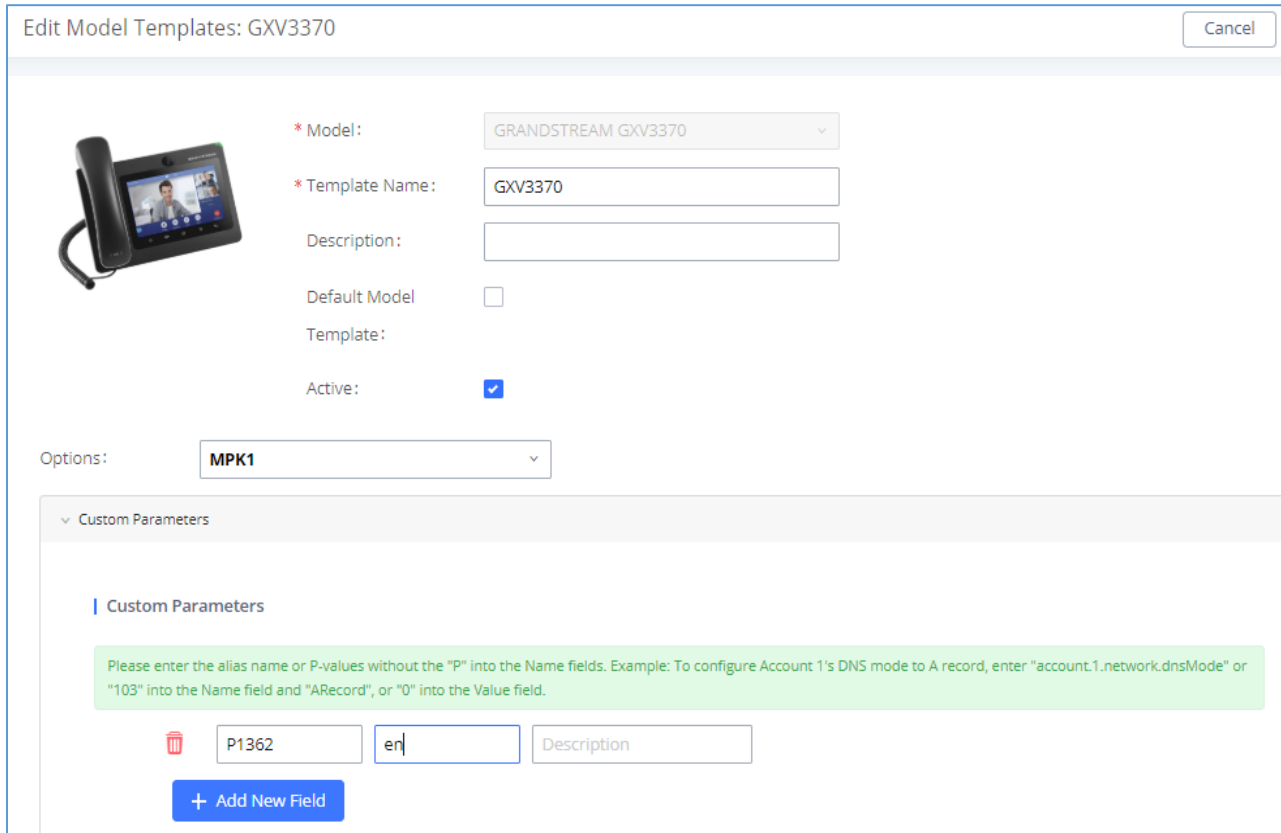
<b>Model</b>	Select a model to apply this template. The supported Grandstream models are listed in the dropdown list for selection.
<b>Template Name</b>	Create a name for the model template.
<b>Description</b>	Enter a description for the model template. This is optional.
<b>Default Model Template</b>	Select to assign this model template as the default model template. The value of the option in default model template will be overwritten if other selected model template has a different value for the same option.
<b>Active</b>	Check this option to enable the model template.

- Click on  to edit the model template.

The editing window for model template is shown in the following figure. In the “Options” field, enter the option name key word, the option that contains the key word will be listed. User could then select the option and click on “Add Option” to add it into the model template.




Once added, the option will be shown in the list below. On the left side of each option, users can click on  to remove this option from the model template. On the right side of each option, users can click on  to reset the option to the default value.



**Figure 67: Edit Model Template**

User could also click on “Add New Field” to add a P value number and the value to the configuration. The following figure shows setting P value “P1362” to “en”, which means the display language on the LCD is set to English. For P value information of different models, please refer to configuration template here <http://www.grandstream.com/sites/default/files/Resources/config-template.zip>.

**Note:** Some devices use Alias and not P-values.


- Click on Save when done. The model template will be displayed on Web GUI→**Value-added Features**→**Zero Config**→**Model Templates** page.
- Click on  to delete the model template or click on “Delete Selected Templates” to delete multiple selected templates at once.
- Click on “Toggle Selected Template(s)” to toggle the status between enabled/disabled for the selected model templates.

## Model Update

UCM6510 zero config feature supports provisioning all models of Grandstream SIP end devices including OEM device models.

### OEM Models

Users can associate OEM device models with their original Grandstream-branded models, allowing these OEM devices to be provisioned appropriately.

- Click on  button.
- In the *Source Model* field, select the Grandstream device that the OEM model is based on from the dropdown list.
- For the *Destination Model* and *Destination Vendor* field, enter the custom OEM model name and vendor name.
- The newly added OEM model should now be selectable as an option in *Model* fields.

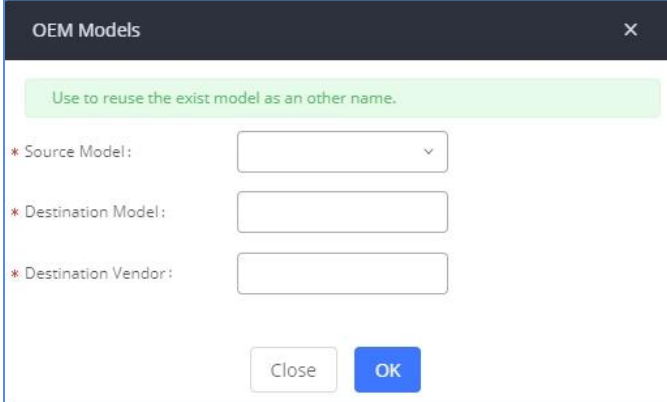




Figure 68: OEM Models

### Model Template Package List

Templates for most of the Grandstream models are built in with the UCM6510 already. Templates for GS Wave and Grandstream surveillance products require users to download and install under Web GUI→**Value-added Features**→**Zero Config**→**Model Update** first before they are available in the UCM6510 for selection. After downloading and installing the model template to the UCM6510, it will show in the dropdown list for “Model” selection when editing the model template.

- Click on  to download the template.
- Click on  to upgrade the model template. Users will see this icon available if the device model has template updated in the UCM6510.



Model Template Package List				
VENDOR	MODEL	VERSION (REMOTE / LOCAL)	SIZE	OPTIONS
Grandstream	DP750	1.0/-	271K	
Grandstream	DP752	1.2/-	58K	
Grandstream	GAC2500	1.0/-	25K	
Grandstream	GDS3705	1.3/-	56K	
Grandstream	GDS3710	1.3/-	97K	
Grandstream	GRP2612	1.0/-	495K	
Grandstream	GRP2612P	1.0/-	495K	
Grandstream	GRP2612W	1.0/-	495K	
Grandstream	GRP2613	1.0/-	67K	
Grandstream	GRP2614	1.3/-	52K	

Figure 69: Template Management

## Upload Model Template Package

In case the UCM6510 is placed in the private network and Internet access is restricted, users will not be able to get packages by downloading and installing from the remote server. Model template packages can be manually uploaded to the UCM. Please contact Grandstream customer support if the model package is needed for manual uploading.

**Upload Model Template Package**

Choose Model Package to

Upload:

Figure 70: Upload Model Template Manually

## Device Configuration

On Web GUI, page **Value-added Features**→**Zero Config**→**Zero Config**, users could create new device, delete existing device(s), make special configuration for a single device, or send NOTIFY to existing device(s).

### Create New Device

Besides configuring the device after the device is discovered, users could also directly create a new device and configure basic settings before the device is discovered by the UCM6510. Once the device is plugged in, it can then be discovered and provisioned. This gives the system administrator adequate time to set up each device beforehand.



Click on “Create New Device” and the following dialog will show. Follow the steps below to create the configurations for the new device.

1. Firstly, select a model for the device to be created and enter its MAC address, IP address and firmware version (optional) in the corresponding field.
2. Basic settings will show a list of settings based on the model selected in step 1. Users could assign extensions to accounts, assign functions to Line Keys and Multiple-Purposed Keys if supported on the selected model.
3. Click on “Create New Device” to save the configuration for this device.

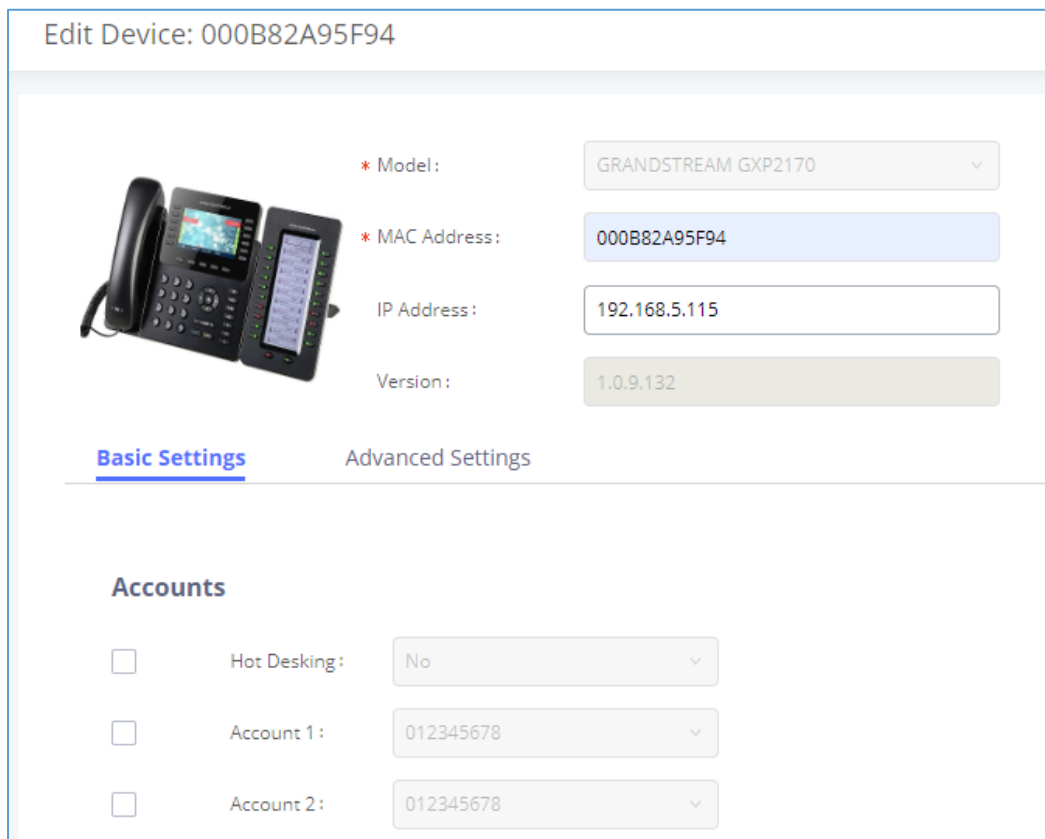


Figure 71 shows the 'Edit Device' configuration page for a Grandstream GXP2170 phone. The page is titled 'Edit Device: 000B82A95F94'. It features a large image of the phone on the left. To the right of the image are four configuration fields:
 

- \* Model: GRANDSTREAM GXP2170 (dropdown menu)
- \* MAC Address: 000B82A95F94 (text input)
- IP Address: 192.168.5.115 (text input)
- Version: 1.0.9.132 (text input)

 Below these fields are two tabs: 'Basic Settings' (selected) and 'Advanced Settings'. Under 'Basic Settings', there is an 'Accounts' section with three rows, each containing a checkbox and a dropdown menu:
 

- Hot Desking: No
- Account 1: 012345678
- Account 2: 012345678

Figure 71: Create New Device

## Manage Devices

The device manually created or discovered from Auto Discover will be listed in the Web GUI→**Value-added Features**→**Zero Config**→**Zero Config** page. Users can see the devices with their MAC address, IP address, vendor, model etc.

<input type="checkbox"/>	000B825C6927	192.168.6.162	1.0.9.9	Grandstream	GXP2160	1					
<input type="checkbox"/>	000B826B1958	192.168.6.115	1.0.3.167	Grandstream	GXV3240	1					
<input type="checkbox"/>	000B826B1FF7	192.168.6.158	1.0.3.171	Grandstream	GXV3240	1					

**Figure 72: Manage Devices**

1. Click on to access the Web GUI of the phone.
2. Click on to edit the device configuration.

A new dialog will be displayed for the users to configure “Basic” settings and “Advanced” settings. “Basic” settings have the same configurations as displayed when manually creating a new device, i.e., account, line key and MPK settings; “Advanced” settings allow users to configure more details in a five-level structure.



Edit Device: 000B8273C559

 \* Model: GRANDSTREAM GXP2130  
 \* MAC Address: 000B8273C559  
 IP Address: 192.168.5.197  
 Version: 1.0.9.127

Basic Settings **Advanced Settings**

**5 Custom Device Settings** **Preview**

[Modify Custom Settings](#)

**4 Model Templates**

0 Item Idle  0 Selected

None None

**3 Default Model Template**





**Figure 73: Edit Device**

A preview of the “Advanced” settings is shown in the above figure. There are five levels configurations as described in (1) (2) (3) (4) (5) below, with priority from the lowest to the highest. The configurations in all levels will take effect for the device. If there are same options existing in different level configurations with different value configured, the higher-level configuration will override the lower level configuration.

(1) Global Policy

This is the lowest level configuration. The global policy configured in Web GUI→**Value-added Features**→**Zero Config**→**Global Policy** will be applied here. Clicking on “Modify Global Policy” to redirect to page **Value-added Features**→**Zero Config**→**Global Policy**.





(2) Global Templates

Select a global template to be used for the device and click on  to add. Multiple global templates can be selected, and users can arrange the priority by adjusting orders via  and . All the selected global templates will take effect. If the same option exists on multiple selected global templates, the value in the template with higher priority will override the one in the template with lower priority. Click on  to remove the global template from the selected list.

(3) Default Model Template

Default Model Template will be applied to the devices of this model. Default model template can be configured in model template under Web GUI→**Value-added Features**→**Zero Config**→**Model Templates** page. Please see default model template option in [\[Table 30: Create New Model Template\]](#).

(4) Model Templates


Select a model template to be used for the device and click on  to add. Multiple global templates can be selected, and users can arrange the priority by adjusting orders via  and . All the selected model templates will take effect. If the same option exists on multiple selected model templates, the value in the template with higher priority will override the one in the template with lower priority. Click on  to remove the model template from the selected list.

(5) Customize Device Settings

This is the highest-level configuration in the “Advanced” settings of the device. Click on “Modify Customize Device Settings” and following dialog will show.



Edit Device: 000B8273C559



Model:	Grandstream GXP2130
MAC Address:	000B8273C559
IP Address:	192.168.5.197
Version:	1.0.9.127

Customize Fields

**Customize Fields**

Please use P-values for the Name fields. <br />Example: To configure Language, enter "P1362" into the Language Value field.

	P1362	en	Description	Possible Match Exists
--	-------	----	-------------	--------------------------

+ Add New Field

**Figure 74: Edit Customize Device Settings**


Scroll down in the dialog to view and edit the device-specific options. If the users would like to add more options which are not in the pre-defined list, click on “Add New Field” to add a P value number and the value to the configuration. The following figure shows setting P value “P1362” to “en”, which means the display language on the LCD is set to English.

The warning information next to the P value field indicates that the option matching the P value number exists in the configuration already.

For P value information of different models, please refer to configuration template here:  
<http://www.grandstream.com/sites/default/files/Resources/config-template.zip>.



Edit Device: 000B8273C559



Model: Grandstream GXP2130

MAC Address: 000B8273C559

IP Address: 192.168.5.197

Version: 1.0.9.127

Customize Fields

**Customize Fields**

Please use P-values for the Name fields. <br />Example: To configure Language, enter "P1362" into the Language Value field.

	P1362	en	Description	Possible Match Exists
--	-------	----	-------------	--------------------------

[+ Add New Field](#)

**Figure 75: Add P Value in Customize Device Settings**


- Select multiple devices that need to be modified and then click on [Modify Selected Devices](#) to batch modify devices.

If selected devices are of the same model, the configuration dialog is like the following figure. Configurations in five levels are all available for users to modify.



Modify Selected Devices

**WARNING: Performing a batch operation will override all the existing device configurations on this page.**



\* Model: GXP2130

MAC Address: 000B8273C556 ×  
000B8273C559 ×


**Basic Settings**    Advanced Settings

**Accounts**

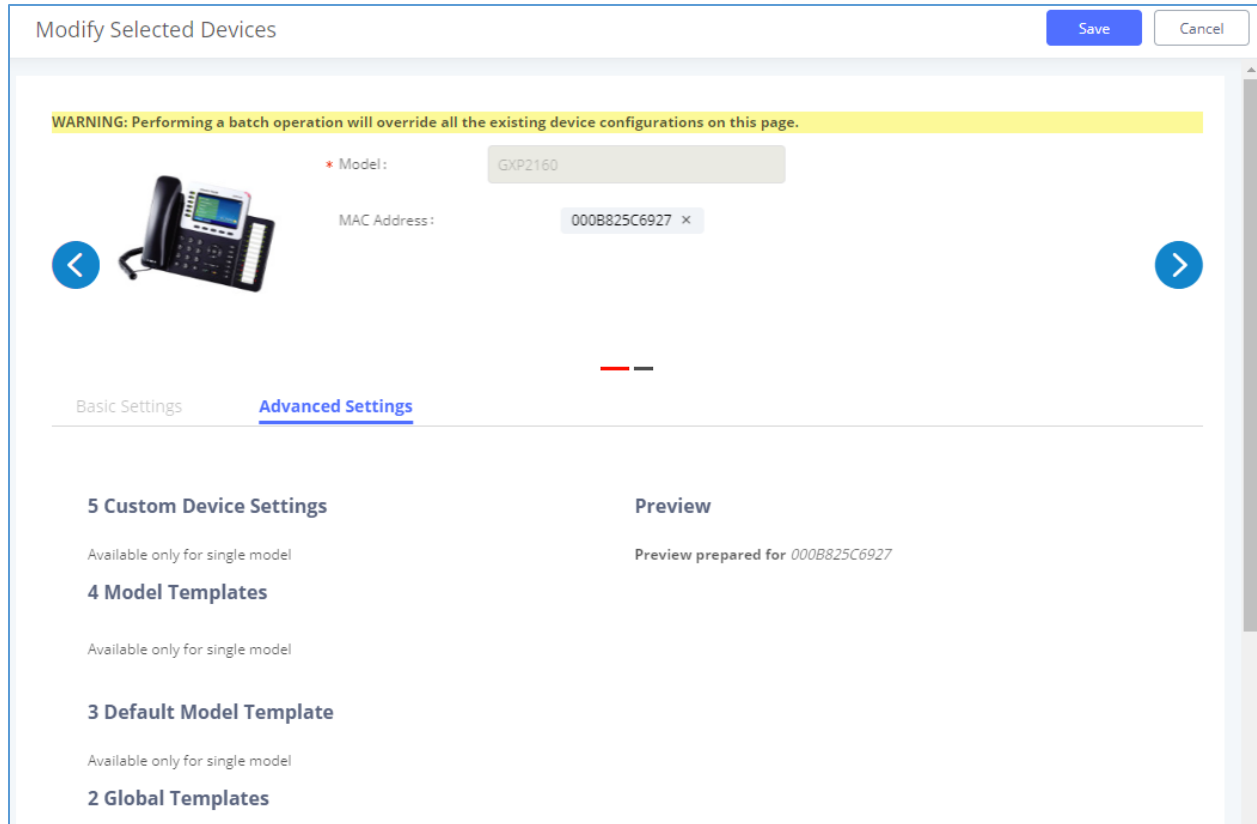
Hot Desking: No

**Virtual Multi-Purpose Key Settings**

**Figure 76: Modify Selected Devices–Same Model**

If selected devices are of different models, the configuration dialog is like the following figure. Click on  to view more devices of other models. Users are only allowed to make modifications in Global Templates and Global Policy level.






**Figure 77: Modify Selected Devices—Different Models**

 **Warning:**

Perform batch operation will override all the configurations made when editing a single device. For example, if the user configures a GXP2140 to use template “TempA” in Global Templates level by editing a single device and then selects several devices including that GXP2140 to batch modify devices selecting “TempB” in Global Templates level, the user will see the global templates changed to “TempB” when viewing the configurations for the GXP2140.
























































After the above configurations, save the changes and go back to Web GUI → **Value-added Features** → **Zero Config** → **Zero Config** page. Users could then click on  to send NOTIFY to the SIP end point device and trigger the provisioning process. The device will start downloading the generated configuration file from the URL contained in the NOTIFY message.

Zero Config

[Zero Config](#)    [Global Policy](#)    [Global Templates](#)    [Model Templates](#)    [Model Update](#)    [Zero Config Settings](#)

[Auto Discover](#)    [Create New Device](#)    [Delete Selected Devices](#)    [Modify Selected Devices](#)    [Reset All Extensions](#)

Filter:

<input type="checkbox"/>	MAC Address ↕	IP Address ↕	Extension	Version ↕	Vendor ↕	Model ↕	Create Config ↕	Options
<input type="checkbox"/>	0008823F8CB0	192.168.6.176	--	1.0.14.100	GRANDSTREAM	HT503	--	    
<input type="checkbox"/>	000882415D27	192.168.6.72	--	1.0.7.80	GRANDSTREAM	GKV3140	--	    
<input type="checkbox"/>	0008825C5806	192.168.6.218	--	1.0.8.50	GRANDSTREAM	GXP2140	--	    
<input type="checkbox"/>	0008825C6926	192.168.2.104	--	1.0.9.17	GRANDSTREAM	GXP2160	--	    
<input type="checkbox"/>	000882681052	192.168.6.146	--	1.0.3.177	GRANDSTREAM	GKV3240	--	    
<input type="checkbox"/>	000882681FF7	192.168.6.144	--	1.0.3.144	GRANDSTREAM	GKV3240	--	    
<input type="checkbox"/>	0008826824CD	192.168.6.45	--	1.0.3.177	GRANDSTREAM	GKV3275	--	    
<input type="checkbox"/>	000882718249	192.168.6.119	--	1.0.4.60	GRANDSTREAM	GXP1625	--	    
<input type="checkbox"/>	000882718419	192.168.6.195	--	1.0.4.56	GRANDSTREAM	GXP1610	--	    
<input type="checkbox"/>	00088275C888	192.168.6.137	--	1.0.8.50	GRANDSTREAM	GXP2130	--	    
<input type="checkbox"/>	000882784681	192.168.6.224	--	0.6.9.61	GRANDSTREAM	GXP1628	--	    

**Figure 78: Device List in Zero Config**

In this web page, users can also click on “Reset All Extensions” to reset the extensions of all the devices.

## Example Application

Assuming in a small business office where there are 8 GXP2140 phones used by customer support and 1 GXV3275 phone used by customer support supervisor. 3 of the 8 customer support members speak Spanish and the rest speak English. We could deploy the following configurations to provisioning the office phones for the customer support team.

1. Go to Web GUI→**Value-added Features**→**Zero Config**→**Auto Provision Settings**, select “Enable Zero Config”.
2. Go to Web GUI→**Value-added Features**→**Zero Config**→**Global Policy**, configure Date Format, Time Format and Firmware Source as follows.



v Localization

### Language Settings

\* Language: ↻ English ▾

### Date and Time

Date Format: ↻ yyyy-mm-dd ▾

Time Format: ↻ 24-hour Clock ▾

Enable NTP: ↻ Disabled ▾

NTP Server: ↻

NTP Update Interval: ↻ 1440

Time Zone: ↻ GMT+08:00 (Beijing, Taipei, ... ▾

Enable Daylight Saving Time: ↻ Disabled ▾

> Phone Settings

> Contact List

v Maintenance

### Upgrade and Provision

Firmware Source:

Source:	<span style="float: right;">↻ URL ▾</span>
Upgrade via:	<span style="float: right;">↻ TFTP ▾</span>
Server Path:	<span style="float: right;">↻ fm.grandstream.com/gs <input type="text"/></span>
File Prefix:	<span style="float: right;">↻ <input type="text"/></span>
File Postfix:	<span style="float: right;">↻ <input type="text"/></span>

Config Server Path: ↻ 192.168.2.1:8089/zccgi/


Allow DHCP Option 43/66: ↻ No ▾

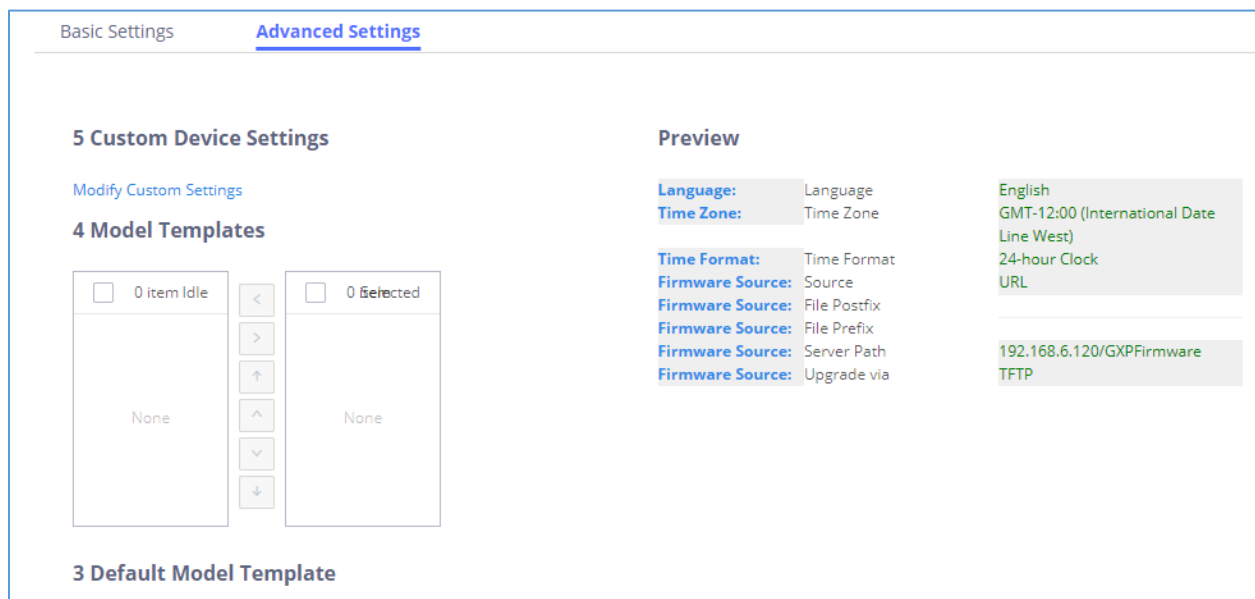
Automatic Upgrade: Periodic option: ↻ Disabled ▾

Firmware Upgrade Rule: ↻ Check new firmware only w... ▾

**Figure 79: Zero Config Sample – Global Policy**



3. Go to Web GUI→**Value-added Features**→**Zero Config**→**Model Templates**, create a new model template “English Support Template” for GXP2140. Add option “Language” and set it to “English”. Then select the option “Default Model Template” to make it the default model template.
4. Go to Web GUI→**Value-added Features**→**Zero Config**→**Model Templates**, create another model template “Spanish Support Template” for GXP2140. Add option “Language” and set it to “Español”.
5. After 9 devices are powered up and connected to the LAN network, use “Auto Discover” function or “Create New Device” function to add the devices to the device list on Web GUI→**Value-added Features**→**Zero Config**→**Zero Config**.
6. On Web GUI→**Value-added Features**→**Zero Config**→**Zero Config** page, users could identify the devices by their MAC addresses or IP addresses displayed on the list. Click on  to edit the device settings.
7. For each of the 5 phones used by English speaking customer support, in “Basic” settings select an available extension for account 1 and click on “Save”. Then click on “Advanced” settings tab to bring up the following dialog. Users will see the English support template is applied since this is the default model template. A preview of the device settings will be listed on the right side.



**Figure 80: Zero Config Sample – Device Preview 1**

8. For the 3 phones used by Spanish support, in “Basic” settings select an available extension for account 1 and click on “Save”. Then click on “Advanced” settings tab to bring up the following dialog.

Basic Settings
Advanced Settings

### 5 Custom Device Settings

Modify Custom Settings

### 4 Model Templates

0 item Idle

0 Selected

<
>
↑
↓

None

None

### 3 Default Model Template

### Preview

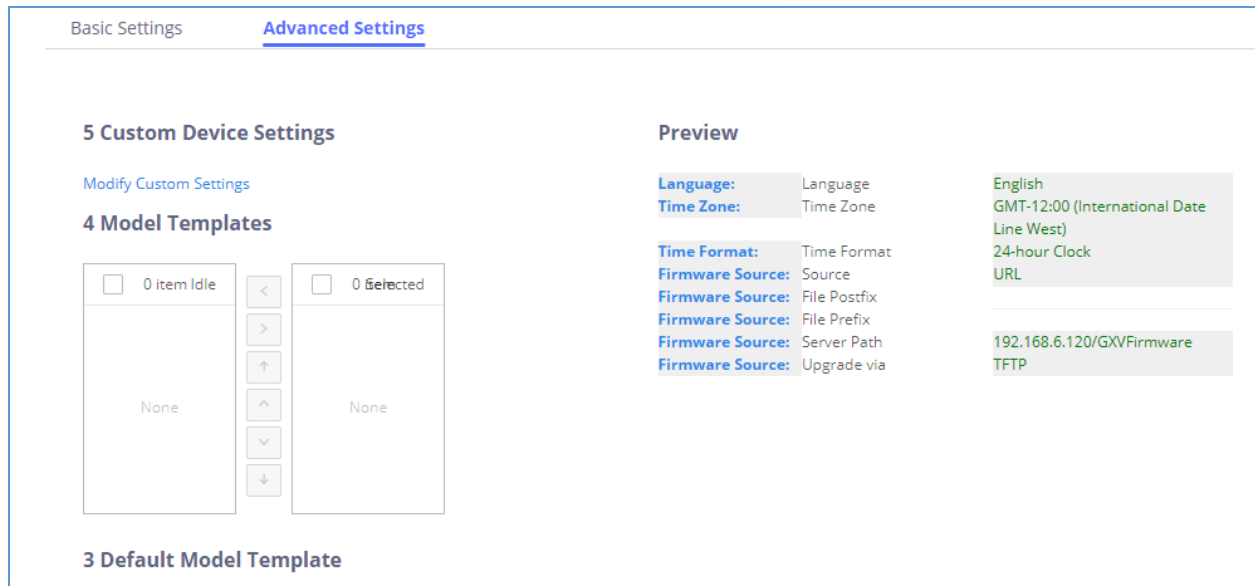
<b>Language:</b>	Language	Español
<b>Time Zone:</b>	Time Zone	GMT-12:00 (International Date Line West)
<b>Time Format:</b>	Time Format	24-hour Clock
<b>Firmware Source:</b>	Source	URL
<b>Firmware Source:</b>	File Postfix	
<b>Firmware Source:</b>	File Prefix	
<b>Firmware Source:</b>	Server Path	192.168.6.120/GXPfirmware
<b>Firmware Source:</b>	Upgrade via	TFTP

**Figure 81: Zero Config Sample – Device Preview 2**


Select “Spanish Support Template” in “Model Template”. The preview of the device settings is displayed on the right side and we can see the language is set to “Español” since Model Template has the higher priority for the option “Language”, which overrides the value configured in default model template.

9. For the GXV3370 used by the customer support supervisor, select an available extension for account 1 on “Basic” settings and click on “Save”. Users can see the preview of the device configuration in “Advanced” settings. There is no model template configured for GXV3370.





**Figure 82: Zero Config Sample – Device Preview 3**

10. Click on “Apply Changes” to apply saved changes.
11. On the Web GUI→**Value-added Features**→**Zero Config**→**Zero Config** page, click on  to send NOTIFY to trigger the device to download config file from UCM6510.

Now all the 9 phones in the network will be provisioned with a unique extension registered on the UCM6510. 3 of the phones will be provisioned to display Spanish on LCD and the other 5 will be provisioned to display English on LCD. The GXV3275 used by the supervisor will be provisioned to use the default language on LCD display since it is not specified in the global policy.





## EXTENSIONS

### Create New User

### Create New SIP Extension

To create a new SIP extension, navigate to **Extension/Trunk**→**Extensions** and click on the Add button. The following window will appear:

Create New Extension
Save

Basic Settings
Media
Features
Specific Time
Follow Me

\* Select Extension Type:

Select Add Method:

---

**General**

* Extension: <input type="text" value="1003"/>	CallerID Number: <input type="text"/>
* Permission: <input type="text" value="Internal"/>	* SIP/IAX Password: <input type="text" value="X7a0c4s"/>
AuthID: <input type="text"/>	Enable Voicemail: <input checked="" type="checkbox"/>
* Voicemail Password: <input type="text" value="081347"/>	Skip Voicemail Password V... <input type="checkbox"/>
Enable Keep-alive: <input type="checkbox"/>	* Keep-alive Frequency: <input type="text" value="60"/>
Disable This Extension: <input type="checkbox"/>	

**User Settings**

First Name: <input type="text"/>	Last Name: <input type="text"/>
Email Address: <input type="text"/>	* User Password: <input type="text" value="L9J6iz"/>
* Language: <input type="text" value="Default"/>	* Concurrent Registration...: <input type="text" value="1"/>
Mobile Phone Number: <input type="text"/>	

**Figure 83: Create New Device**

SIP extension options are divided into four categories:

- Basic Settings
- Media
- Features
- Specific Time
- Follow Me



Click on the tab to view or edit options belonging to that category. The configuration parameters are as follows.

**Table 31: SIP Extension Configuration Parameters – Basic Settings**

General	
<b>Extension</b>	The extension number associated with the user. <b>Note:</b> This field supports (+) sign.
<b>CallerID Number</b>	Configure the CallerID Number that would be applied for outbound calls from this user. <b>Note:</b> The ability to manipulate your outbound Caller ID may be limited by your VoIP provider.
<b>Permission</b>	Assign permission level to the user. The available permissions are “Internal”, “Local”, “National” and “International” from the lowest level to the highest level. The default setting is “Internal”. <b>Note:</b> Users need to have the same level as or higher level than an outbound rule’s privilege to make outbound calls using this rule.
<b>SIP/IAX Password</b>	Configure the password for the user. A random secure password will be automatically generated. It is recommended to use this password for security purpose.
<b>Auth ID</b>	Configure the authentication ID for the user. If not configured, the extension number will be used for authentication. <b>Note:</b> This field supports (+) sign.
<b>Voicemail</b>	Configure Voicemail. There are three valid options and the default option is "Enable Local Voicemail". <ul style="list-style-type: none"> <li><b>Disable Voicemail:</b> Disable Voicemail.</li> <li><b>Enable Local Voicemail:</b> Enable voicemail for the user.</li> <li><b>Enable Remote Voicemail:</b> Forward the notify message from remote voicemail system for the user, and the local voicemail will be disabled. <b>Note:</b> Remote voicemail feature is used only for Infomatec (Brazil).</li> </ul>
<b>Voicemail Password</b>	Configure the password to access the extension's voicemail. A randomly generated password is used by default and is highly recommended for security. Only digits are supported.
<b>Skip Voicemail Password Verification</b>	If enabled, users can skip password verification when dialing in via the My Voicemail feature code. This option is disabled by default.
<b>Send Voicemail to Email</b>	If enabled, the voicemail will be attached to the email notification that is sent when a voicemail is received. <b>Note:</b> When set to "Default", the global settings in <b>Call Features</b> → <b>Voicemail</b> → <b>Voicemail Email Settings</b> will be used.



<b>Keep Voicemail after Emailing</b>	Configure whether or not to retain the voicemail in local storage after sending the voicemail attachment in the email notification.
<b>Enable Keep-alive</b>	If enabled, empty SDP packet will be sent to the SIP server periodically to keep the NAT port open. The default setting is "Yes".
<b>Keep-alive Frequency</b>	Configure the Keep-alive interval (in seconds) to check if the host is up. The default setting is 60 seconds.
<b>Disable This Extension</b>	If selected, this extension will be disabled on the UCM6510. <b>Note:</b> The disabled extension still exists on the PBX but cannot be used on the end device.
<b>User Settings</b>	
<b>First Name</b>	Configure the user's first name. This field supports alphanumeric characters, underscores (_), and periods.
<b>Last Name</b>	Configures the user's last name. This field supports alphanumeric characters, underscores (_), and periods.
<b>Email Address</b>	Configure the user's email address. Email notifications will be sent to this address.
<b>User Password</b>	Configure the password for user portal access. A random password is automatically generated by default and is highly recommended for security.
<b>Language</b>	Select the voice prompt language that will be used for this extension. By default, the selected voice prompt language under <b>PBX Settings→Voice Prompt→Language</b> Settings will be used. To add more supported languages, please download the voice prompt language packages in the same page.
<b>Concurrent Registrations</b>	The maximum allowed number of endpoint registrations to this extension. Default value is 1.
<b>Mobile Phone Number</b>	Configure a phone number for the extension. Users can dial the Direct Dial Mobile Phone Prefix feature code (*88 by default) + extension number to directly dial this number. Example: Dial *881000 to call the mobile number associated with extension 1000.



**Table 32: SIP Extension Configuration Parameters – Media**

SIP Settings	
<b>NAT</b>	Use NAT when the UCM6510 is on a public IP communicating with devices hidden behind NAT (e.g., broadband router). If there is one-way audio issue, usually it is related to NAT configuration or Firewall's support of SIP and RTP ports. The default setting is enabled.
<b>Enable Direct Media</b>	By default, the UCM6510 will route the media streams from SIP endpoints through itself. If enabled, the PBX will attempt to negotiate with the endpoints to route the media stream directly. It is not always possible for the UCM6510 to negotiate endpoint-to-endpoint media routing. The default setting is "No".
<b>DTMF Mode</b>	Select DTMF mode for the user to send DTMF. The default setting is "RFC4733". If "Info" is selected, SIP INFO message will be used. If "Inband" is selected, 64-kbit PCMU and PCMA are required. When "Auto" is selected, RFC4733 will be used if offered, otherwise "Inband" will be used.
<b>TEL URI</b>	If the phone has an assigned PSTN telephone number, this field should be set to "User=Phone". "User=Phone" parameter will be attached to the Request-Line and "TO" header in the SIP request to indicate the E.164 number. If set to "Enable", "Tel" will be used instead of "SIP" in the SIP request.
<b>Alert-Info</b>	Configure the Alert-Info, when UCM6510 receives an INVITE request, the Alert-Info header field specifies an alternative ring tone to the UAS.
<b>Enable T.38 UDPTL</b>	Enable or disable T.38 UDPTL support.
<b>SRTP</b>	Enable SRTP for the call. The default setting is disabled.
<b>Fax Mode</b>	Select Fax mode. The default setting is "None". <ul style="list-style-type: none"> <li>• <b>None:</b> Disable Fax.</li> <li>• <b>Fax Detect:</b> Fax signal from the user/trunk during the call can be detected and the received Fax will be sent to the Email address configured for this extension. If no Email address can be found for the user, the Fax will be sent to the default Email address configured in Fax setting page under Web GUI→Call Features→Fax/T.38.</li> </ul>
<b>Fax to Email</b>	<ul style="list-style-type: none"> <li>• <b>Yes</b> – Allow Fax to Email for this extension. Faxes will be sent to the user's email address configured in the extension's <i>Basic Settings</i>.</li> <li>• <b>No</b> – Do not send any faxes to the user's email address configured in the extension's <i>Basic Settings</i>.</li> </ul>



<b>ACL Policy</b>	<p>Access Control List manages the IP addresses that can register to this extension.</p> <ul style="list-style-type: none"> <li>• <b>Allow All:</b> Any IP address can register to this extension.</li> <li>• <b>Local Network Address:</b> Only IP addresses in the configured network segments can register to this extension.</li> </ul>
<b>Local Network Address</b>	<p>Specifies allowed IP address or networks from where the extension can be registered. Up to 10 entries are allowed.</p> <p>Format: "xxx.xxx.xxx.xxx", "xxx.xxx.xxx.xxx/32", "[::]" or "[::]/128".</p>
<b>Codec Preference</b>	<p>Select audio and video codec for the extension. The available codecs are: PCMU, PCMA, GSM, AAL2-G.726-32, G.726, G.722, G.729, G.723, OPUS, iLBC, ADPCM, H.264, H.265, H.263, H.263p and RTX.</p>

**Table 33: SIP Extension Configuration Parameters – Features**

Call Transfer	
<b>Presence Status</b>	<p>Select which presence status to set for the extension and configure call forward conditions for each status. Six possible options are possible: <b>“Available”</b>, <b>“Away”</b>, <b>“Chat”</b>, <b>“Custom”</b>, <b>“DND”</b> and <b>“Unavailable”</b>.</p> <p>More details at [PRESENCE]</p>
<b>Call Forward Unconditional</b>	<p>Enable and configure the Call Forward Unconditional target number. Available options for target number are:</p> <ul style="list-style-type: none"> <li>• <b>“None”</b>: Call forward deactivated.</li> <li>• <b>“Extension”</b>: Select an extension from dropdown list as CFU target.</li> <li>• <b>“Custom Number”</b>: Enter a customer number as target. For example: *97.</li> <li>• <b>“Voicemail”</b>: Select an extension from dropdown list. Incoming calls will be forwarded to voicemail of selected extension.</li> <li>• <b>“Ring Group”</b>: Select a ring group from dropdown list as CFU target.</li> <li>• <b>“Queues”</b>: Select a queue from dropdown list as CFU target.</li> <li>• <b>“Voicemail Group”</b>: Select a voicemail group from dropdown list as CFU target.</li> </ul> <p>The default setting is “None”.</p>
<b>CFU Time Condition</b>	<p>Select time condition for Call Forward Unconditional. CFU takes effect only during the selected time condition. The available time conditions are “Office Time”, “Out of Office Time”, “Holiday”, “Out of Holiday”, “Out of Office Time or Holiday” and “Specific”.</p> <p><b>Notes:</b></p> <ul style="list-style-type: none"> <li>• “Specific” has higher priority to “Office Times” if there is a conflict in terms of time period.</li> <li>• Specific Time can be configured in the Specific Time tab.</li> </ul>



	<ul style="list-style-type: none"> <li>Office Time and Holiday can be configured in <b>System Settings→Time Settings→Office Time/Holiday</b> page.</li> </ul>
<b>Call Forward No Answer</b>	<p>Configure the Call Forward No Answer target number. Available options for target number are:</p> <ul style="list-style-type: none"> <li><b>“None”</b>: Call forward deactivated.</li> <li><b>“Extension”</b>: Select an extension from dropdown list as CFN target.</li> <li><b>“Custom Number”</b>: Enter a customer number as target. For example: *97.</li> <li><b>“Voicemail”</b>: Select an extension from dropdown list. Incoming calls will be forwarded to voicemail of selected extension.</li> <li><b>“Ring Group”</b>: Select a ring group from dropdown list as CFN target.</li> <li><b>“Queues”</b>: Select a queue from dropdown list as CFN target.</li> <li><b>“Voicemail Group”</b>: Select a voicemail group from dropdown list as CFN target.</li> </ul>
<b>CFN Time Condition</b>	<p>Select time condition for Call Forward No Answer. The available time conditions are “Office Time”, “Out of Office Time”, “Holiday”, “Out of Holiday”, “Out of Office Time or Holiday” and “Specific”.</p> <p><b>Notes:</b></p> <ul style="list-style-type: none"> <li>“Specific” has higher priority to “Office Times” if there is a conflict in terms of time period.</li> <li>Specific Time can be configured in the Specific Time tab.</li> <li>Office Time and Holiday could be configured on page <b>System Settings→Time Settings→Office Time/Holiday</b> page.</li> </ul>
<b>Call Forward Busy</b>	<p>Configure the Call Forward Busy target number. Available options for target number are:</p> <ul style="list-style-type: none"> <li><b>“None”</b>: Call forward deactivated.</li> <li><b>“Extension”</b>: Select an extension from dropdown list as CFB target.</li> <li><b>“Custom Number”</b>: Enter a customer number as target. For example: *97.</li> <li><b>“Voicemail”</b>: Select an extension from dropdown list. Incoming calls will be forwarded to voicemail of selected extension.</li> <li><b>“Ring Group”</b>: Select a ring group from dropdown list as CFB target.</li> <li><b>“Queues”</b>: Select a queue from dropdown list as CFB target.</li> <li><b>“Voicemail Group”</b>: Select a voicemail group from dropdown list as CFB target.</li> </ul>
<b>CFB Time Condition</b>	<p>Select time condition for Call Forward Busy. The available time conditions are “Office Time”, “Out of Office Time”, “Holiday”, “Out of Holiday”, “Out of</p>



	<p>Office Time or Holiday” and “Specific”.</p> <p><b>Notes:</b></p> <ul style="list-style-type: none"> <li>• “Specific” has higher priority to “Office Times” if there is a conflict in terms of time period.</li> <li>• Specific time can be configured on the bottom of the extension configuration dialog. Scroll down the add Time Condition for specific time.</li> <li>• Office Time and Holiday could be configured on page <b>System Settings</b>→<b>Time Settings</b>→<b>Office Time/Holiday</b> page.</li> </ul>
<b>Do Not Disturb</b>	If enabled the extension will ignore all incoming calls
<b>DND Time Condition</b>	<p>Select time condition for Do Not Disturb. The available time conditions are “Office Time”, “Out of Office Time”, “Holiday”, “Out of Holiday”, “Out of Office Time or Holiday” and “Specific”.</p> <p><b>Notes:</b></p> <ul style="list-style-type: none"> <li>• “Specific” has higher priority to “Office Times” if there is a conflict in terms of time period.</li> <li>• Specific time can be configured on the bottom of the extension configuration dialog. Scroll down the add Time Condition for specific time.</li> <li>• Office Time and Holiday could be configured on page <b>System Settings</b>→<b>Time Settings</b>→<b>Office Time/Holiday</b> page.</li> </ul>
<b>DND Whitelist</b>	<p>If DND is enabled, all calls to this extension will be rejected except the numbers listed on this list.</p> <p><b>Note:</b> The maximum number on the Whitelist is 10.</p>
<b>FWD Whitelist</b>	<p>If call forward is enabled, all calls to this extension will be forwarded except the calls coming from the specified numbers on this list.</p> <p><b>Note:</b> The Maximum number on the whitelist is 10.</p>
<b>CC Settings</b>	
<b>Enable CC</b>	If enabled, UCM6510 will automatically alert this extension when a called party is available, given that a previous call to that party failed for some reason. By default, it is disabled.
<b>CC Mode</b>	<p>Two modes for Call Completion are supported:</p> <ul style="list-style-type: none"> <li>• <b>Normal:</b> This extension is used as ordinary extension.</li> <li>• <b>For Trunk:</b> This extension is registered from a PBX.</li> </ul> <p>The default setting is “Normal”.</p> <p><b>Note:</b> The number of CC agents (for “Normal” mode) will now be limited by the extensions’ allowed number of concurrent registrations.</p>



<b>CC Max Agents</b>	Configure the maximum number of CCSS agents which may be allocated for this channel (when CC Mode is set to “For Trunk”). In other words, this number serves as the maximum number of CC requests this channel is allowed to make. Min. value is 1.
<b>CC Max Monitors</b>	Configure the maximum number of monitor structures which may be created for this device (when CC Mode is set to “For Trunk”). This number tells how many callers may request CC services for a specific device at one time. The minimum value is 1.
<b>Ring Simultaneously</b>	
<b>Ring Simultaneously</b>	Enable this option to have an external number ring simultaneously along with the extension. If a register trunk is used for outbound, the register number will be used to be displayed for the external number as caller ID number.
<b>External Number</b>	Set the external number to be rang simultaneously. ‘-’ is the connection character which will be ignored. This field accepts only letters, numbers, and special characters + = * #.
<b>Time Condition for Ring Simultaneously</b>	Ring the external number simultaneously along with the extension based on this time condition.
<b>Use callee DOD on FWD or Ring Simultaneously</b>	Use the DOD number when calls are being diverted/forwarded to external destinations or when ring simultaneous is configured.
<b>Monitor privilege control</b>	
<b>Allow call-barging</b>	Add members from “Available Extensions” to “Selected Extensions” so that the selected extensions can spy on the used extension using feature code.
<b>Seamless transfer privilege control</b>	
<b>Allowed to seamless transfer</b>	Any extensions on the UCM can perform seamless transfer. When using Pickup Incall feature, only extensions available on the “Selected Extensions” list can perform seamless transfer to the edited extension.
<b>Other Settings</b>	
<b>Ring Timeout</b>	Configure the number of seconds to ring the user before the call is forwarded to voicemail (voicemail is enabled) or hang up (voicemail is disabled). If not specified, the default ring timeout is 60 seconds on the UCM6510, which can be configured in the global ring timeout setting under Web GUI→ <b>PBX Settings</b> → <b>General Settings</b> : General Preference. The valid range is between 5 seconds and 600 seconds.  <b>Note:</b> If the end point also has a ring timeout configured, the actual ring timeout used is the shortest time set by either device.





<b>Auto Record</b>	Enable automatic recording for the calls using this extension. The default setting is disabled. The recording files can be accessed under Web GUI→ <b>CDR</b> → <b>Recording Files</b> .
<b>Skip Trunk Auth</b>	<ul style="list-style-type: none"> <li>• If set to <b>'Yes'</b>, users can skip entering the password when making outbound calls.</li> <li>• If set to <b>'By Time'</b>, users can skip entering the password when making outbound calls during the selected time condition.</li> <li>• If set to <b>'No'</b>, users will be asked to enter the password when making outbound calls.</li> </ul>
<b>Time Condition for Skip Trunk Auth</b>	If 'Skip Trunk Auth' is set to 'By Time', select a time condition during which users can skip entering password when making outbound calls.
<b>Dial Trunk Password</b>	Configure personal password when making outbound calls via trunk.
<b>Support Hot-Desking Mode</b>	If enabled, SIP Password will accept only alphabet characters and digits. Auth ID will be changed to the same as Extension.
<b>Enable LDAP</b>	If enabled, the extension will be added to LDAP Phonebook PBX list.
<b>Enable WebRTC Support</b>	Enable registration and call from Web RTC.
<b>Music On Hold</b>	Specify which Music On Hold playlist to suggest to the bridged channel when putting them on hold.
<b>Enable Seamless Transfer</b>	Enable the seamless transfer for this extension.
<b>Permission</b>	Set the permission for this extension when using the seamless transfer
<b>Call Duration Limit</b>	The maximum duration of call-blocking.
<b>Maximum Call Duration</b>	The maximum call duration (in seconds). The default value 0 means no limit.
<b>Custom Call-info for Auto Answer</b>	If enabled, when a call is sent to this extension from UCM, the SIP INVITE message will contain a Call-info header indicating auto answer.
<b>Enable Call Waiting</b>	If disabled, UCM will not ring the extension if it is already in a call and will give the caller a busy response.

**Table 34: SIP Extension Configuration Parameters – Specific Time**

Specific Time	
<b>Time Condition</b>	Click to add Time Condition to configure specific time for this extension.



## Create New IAX Extension

The UCM6510 supports Inter-Asterisk eXchange (IAX) protocol. IAX is used for transporting VoIP telephony sessions between servers and terminal devices. IAX is similar to SIP but also has its own characteristic. For more information, please refer to RFC5465.

To manually create new IAX user, go to Web GUI→**Extension/Trunk**→**Extensions**. Click on "Add" and a new dialog window will show for users which need to make sure first to select the extension type to be IAX Extension before proceeding to fill in the extension information. The configuration parameters are as follows.

**Table 35: IAX Extension Configuration Parameters – Basic Settings**

General	
<b>Extension</b>	The extension number associated with the user.
<b>CallerID Number</b>	Configure the CallerID Number that would be applied for outbound calls from this user. <b>Note:</b> The ability to manipulate your outbound Caller ID may be limited by your VoIP provider.
<b>Permission</b>	Assign permission level to the user. The available permissions are "Internal", "Local", "National" and "International" from the lowest level to the highest level. The default setting is "Internal". <b>Note:</b> Users need to have the same level as or higher level than an outbound rule's privilege in order to make outbound calls using this rule.
<b>SIP/IAX Password</b>	Configure the password for the user. A random secure password will be automatically generated. It is recommended to use this password for security purpose.
<b>Voicemail</b>	Configure Voicemail. There are two valid options and the default option is "Enable Local Voicemail". <ul style="list-style-type: none"> <li>• <b>Disable Voicemail:</b> Disable Voicemail.</li> <li>• <b>Enable Local Voicemail:</b> Enable voicemail for the user.</li> </ul>
<b>Voicemail Password</b>	Configure the password to access the extension's voicemail. A randomly generated password is used by default and is highly recommended for security. Only digits are supported.
<b>Skip Voicemail Password Verification</b>	If enabled, users can skip password verification when dialing in via the My Voicemail feature code. This option is disabled by default.
<b>Disable This Extension</b>	If selected, this extension will be disabled on the UCM6510. <b>Note:</b> The disabled extension still exists on the PBX but cannot be used on the end device.
User Settings	
<b>First Name</b>	Configure the user's first name. This field supports alphanumeric



	characters, underscores (_), and periods.
<b>Last Name</b>	Configures the user's last name. This field supports alphanumeric characters, underscores (_), and periods.
<b>Email Address</b>	Configure the user's email address. Email notifications will be sent to this address.
<b>User Password</b>	Configure the password for user portal access. A random password is automatically generated by default and is highly recommended for security.
<b>Language</b>	Select the voice prompt language that will be used for this extension. By default, the selected voice prompt language under <b>PBX Settings→Voice Prompt→Language</b> Settings will be used. To add more supported languages, please download the voice prompt language packages in the same page.

**Table 36: IAX Extension Configuration Parameters – Media**

SIP Settings	
<b>Max Number of Calls</b>	Configure the maximum number of calls allowed for each remote IP address.
<b>Require Call Token</b>	Configure to enable/disable requiring call token. If set to “Auto”, it might lock out users who depend on backward compatibility when peer authentication credentials are shared between physical endpoints. The default setting is “Yes”.
<b>SRTP</b>	Enable SRTP for the call. The default setting is disabled.
<b>Fax Mode</b>	<p>Select Fax Mode. The default setting is “None”.</p> <ul style="list-style-type: none"> <li>• <b>None:</b> Disable Fax. This is the default setting.</li> <li>• <b>Fax Detect:</b> Fax signal from the user/trunk during the call can be detected and the received Fax will be sent to the Email address configured for this extension. If no Email address can be found for the user, the Fax will be sent to the default Email address configured in Fax setting page under Web GUI→<b>Call Features</b>→<b>Fax/T.38</b>.</li> </ul>
<b>ACL Policy</b>	<p>This option controls how the extension can be used on devices within diverse types of network. (The default setting is “Allow All”).</p> <ul style="list-style-type: none"> <li>• <b>Allow All</b> Device in any network can register this extension.</li> <li>• <b>Local Network Address</b> Only IP addresses in the configured network segments can register to this extension.</li> </ul>
<b>Codec Preference</b>	Select audio and video codec for the extension. The available codecs are:



PCMU, PCMA, GSM, AAL2-G.726-32, G,726, G.722, G.729, G.723, ILBC, ADPCM, H.264, H.265, H.263 and H.263p.

**Table 37: IAX Extension Configuration Parameters – Features**

Call Transfer	
<b>Call Forward Unconditional</b>	Configure the Call Forward Unconditional target number. If not configured, the Call Forward Unconditional feature is deactivated. The default setting is deactivated.
<b>CFU Time Condition</b>	<p>Select time condition for Call Forward Unconditional. CFU takes effect only during the selected time condition. The available time conditions are “Office Time”, “Out of Office Time”, “Holiday”, “Out of Holiday”, “Out of Office Time or Holiday” and “Specific”.</p> <p><b>Notes:</b></p> <ul style="list-style-type: none"> <li>• “Specific” has higher priority to “Office Times” if there is a conflict in terms of time period.</li> <li>• Specific Time can be configured in the Specific Time tab.</li> <li>• Office Time and Holiday can be configured in <b>System Settings→Time Settings→Office Time/Holiday</b> page.</li> </ul>
<b>Call Forward No Answer</b>	Configure the Call Forward No Answer target number. If not configured, the Call Forward No Answer feature is deactivated. The default setting is deactivated.
<b>CFN Time Condition</b>	<p>Select time condition for Call Forward No Answer. The available time conditions are “Office Time”, “Out of Office Time”, “Holiday”, “Out of Holiday”, “Out of Office Time or Holiday” and “Specific”.</p> <p><b>Notes:</b></p> <ul style="list-style-type: none"> <li>• “Specific” has higher priority to “Office Times” if there is a conflict in terms of time period.</li> <li>• Specific Time can be configured in the Specific Time tab.</li> <li>• Office Time and Holiday can be configured in <b>System Settings→Time Settings→Office Time/Holiday</b> page.</li> </ul>
<b>Call Forward Busy</b>	Configure the Call Forward Busy target number. If not configured, the Call Forward Busy feature is deactivated. The default setting is deactivated.



<b>CFB Time Condition</b>	<p>Select time condition for Call Forward Busy. The available time conditions are “Office Time”, “Out of Office Time”, “Holiday”, “Out of Holiday”, “Out of Office Time or Holiday” and “Specific”.</p> <p><b>Notes:</b></p> <ul style="list-style-type: none"> <li>• “Specific” has higher priority to “Office Times” if there is a conflict in terms of time period.</li> <li>• Specific Time can be configured in the Specific Time tab.</li> <li>• Office Time and Holiday can be configured in <b>System Settings→Time Settings→Office Time/Holiday</b> page.</li> </ul>
<b>Ring Simultaneously</b>	
<b>Ring Simultaneously</b>	<p>Enable this option to have an external number ring simultaneously along with the extension. If a register trunk is used for outbound, the register number will be used to be displayed for the external number as caller ID number.</p>
<b>External Number</b>	<p>Set the external number to be rang simultaneously. ‘-’ is the connection character which will be ignored.</p>
<b>Time Condition for Ring Simultaneously</b>	<p>Ring the external number simultaneously along with the extension on the basis of this time condition.</p>
<b>Other Settings</b>	
<b>Ring Timeout</b>	<p>Configure the number of seconds to ring the user before the call is forwarded to voicemail (voicemail is enabled) or hang up (voicemail is disabled). If not specified, the default ring timeout is 60 seconds on the UCM6510, which can be configured in the global ring timeout setting under Web GUI→<b>PBX Settings→General Settings</b>: General Preference. The valid range is between 5 seconds and 600 seconds.</p> <p><b>Note:</b></p> <p>If the end point also has a ring timeout configured, the actual ring timeout used is the shortest time set by either device.</p>
<b>Auto Record</b>	<p>Enable automatic recording for the calls using this extension. The default setting is disabled. The recording files can be accessed under Web GUI→<b>CDR→Recording Files</b>.</p>
<b>Skip Trunk Auth</b>	<ul style="list-style-type: none"> <li>• If set to “<b>Yes</b>”, users can skip entering the password when making outbound calls.</li> <li>• If set to “<b>By Time</b>”, users can skip entering the password when making outbound calls during the selected time condition.</li> <li>• If set to “<b>No</b>”, users will be asked to enter the password when making outbound calls.</li> </ul>
<b>Time Condition for Skip Trunk Auth</b>	<p>If “Skip Trunk Auth” is set to “By Time”, select a time condition during which users can skip entering password when making outbound calls.</p>



<b>Dial Trunk Password</b>	Configure personal password when making outbound calls via trunk.
<b>Enable LDAP</b>	If enabled, the extension will be added to LDAP Phonebook PBX lists.
<b>Music On Hold</b>	Configure the Music On Hold playlist to suggest to the bridged channel when putting them on hold.
<b>Call Duration Limit</b>	The maximum duration of call-blocking.

**Table 38: IAX Extension Configuration Parameters – Specific Time**

Specific Time	
<b>Time Condition</b>	Click to add Time Condition to configure specific time for this extension.

## Create New FXS Extension

The UCM6510 supports Foreign eXchange Subscriber (FXS) interface. FXS is used when user needs to connect analog phone lines or FAX machines to the UCM6510.

To manually create new FXS user, go to Web GUI→**Extension/Trunk**→**Extensions**. Click on "Add" and a new dialog window will show for users which need to make sure first to select the extension type to be FXS Extension before proceeding to fill in the extension information. The configuration parameters are as follows.

**Table 39: FXS Extension Configuration Parameters – Basic Settings**

General	
<b>Extension</b>	The extension number associated with the user.
<b>Analog Station</b>	Select the FXS port to be assigned for this extension.
<b>CallerID Number</b>	Configure the CallerID Number that would be applied for outbound calls from this user.  <b>Note:</b> The ability to manipulate your outbound Caller ID may be limited by your VoIP provider.
<b>Permission</b>	Assign permission level to the user. The available permissions are "Internal", "Local", "National" and "International" from the lowest level to the highest level. The default setting is "Internal".  <b>Note:</b> Users need to have the same level as or higher level than an outbound rule's privilege in order to make outbound calls using this rule.
<b>Voicemail</b>	Configure Voicemail. There are three valid options and the default option is "Enable Local Voicemail". <ul style="list-style-type: none"> <li>• <b>Disable Voicemail:</b> Disable Voicemail.</li> <li>• <b>Enable Local Voicemail:</b> Enable voicemail for the user.</li> </ul>
<b>Voicemail Password</b>	Configure the password to access the extension's voicemail. A randomly generated password is used by default and is highly recommended for



	security. Only digits are supported.
<b>Skip Voicemail Password Verification</b>	If enabled, users can skip password verification when dialing in via the My Voicemail feature code. This option is disabled by default.
<b>Disable This Extension</b>	If selected, this extension will be disabled on the UCM6510. <b>Note:</b> The disabled extension still exists on the PBX but cannot be used on the end device.
<b>User Settings</b>	
<b>First Name</b>	Configure the user's first name. This field supports alphanumeric characters, underscores (_), and periods.
<b>Last Name</b>	Configures the user's last name. This field supports alphanumeric characters, underscores (_), and periods.
<b>Email Address</b>	Configure the user's email address. Email notifications will be sent to this address.
<b>User Password</b>	Configure the password for user portal access. A random password is automatically generated by default and is highly recommended for security.
<b>Language</b>	Select the voice prompt language that will be used for this extension. By default, the selected voice prompt language under <b>PBX Settings→Voice Prompt→Language</b> Settings will be used. To add more supported languages, please download the voice prompt language packages in the same page.

Table 40: FXS Extension Configuration Parameters – Media

<b>Analog Settings</b>	
<b>Call Waiting</b>	Configure to enable/disable call waiting feature. The default setting is “No”.
<b>User ‘#’ as SEND</b>	If configured, the # key can be used as SEND key after dialing the number on the analog phone. The default setting is “Yes”.
<b>RX Gain</b>	Configure the RX gain for the receiving channel of analog FXS port. The valid range is -30Db to +6Db. The default setting is 0.
<b>TX Gain</b>	Configure the TX gain for the transmitting channel of analog FXS port. The valid range is -30Db to +6Db. The default setting is 0.
<b>MIN RX Flash</b>	Configure the minimum period of time (in milliseconds) that the hook-flash



	must remain unpressed for the PBX to consider the event as a valid flash event. The valid range is 30ms to 1000ms. The default setting is 200ms.
<b>MAX RX Flash</b>	Configure the maximum period of time (in milliseconds) that the hook-flash must remain unpressed for the PBX to consider the event as a valid flash event. The minimum period of time is 256ms and it cannot be modified. The default setting is 1250ms.
<b>Enable Polarity Reversal</b>	If enabled, a polarity reversal will be marked as received when an outgoing call is answered by the remote party. For some countries, a polarity reversal is used for signaling the disconnection of a phone line and the call will be considered as hang up on a polarity reversal. The default setting is "Yes".
<b>Echo Cancellation</b>	Specify "ON", "OFF" or a value (the power of 2) from 32 to 1024 as the number of taps of cancellation. <b>Note:</b> When configuring the number of taps, the number 256 is not translated into 256ms of echo cancellation. Instead, 256 taps mean $256/8 = 32$ ms. The default setting is "ON", which is 128 taps.
<b>3-Way Calling</b>	Configure to enable/disable 3-way calling feature on the user. The default setting is enabled.
<b>Send CallerID After</b>	Configure the number of rings before sending CID. Default setting is 1.
<b>Fax Mode</b>	For FXS extension, there are three options available in Fax Mode. The default setting is "None". <ul style="list-style-type: none"> <li>• <b>None:</b> Disable Fax.</li> <li>• <b>Fax Detect:</b> Fax signal from the user/trunk during the call can be detected and the received Fax will be sent to the Email address configured for this extension.</li> <li>• If no Email address can be found for the user, the Fax will be sent to the default Email address configured in Fax setting page under Web GUI→Call Features→Fax/T.38.</li> <li>• <b>Fax Gateway:</b> If selected, the UCM6510 can support conversation and processing of Fax data from T.30 to T.38 or T.38 to T.30. This feature is only available for FXS or FXO port.</li> </ul>

**Table 41: FXS Extension Configuration Parameters – Features**

Call Transfer	
<b>Call Forward Unconditional</b>	Configure the Call Forward Unconditional target number. If not configured, the Call Forward Unconditional feature is deactivated. The default setting





	is deactivated.
<b>CFU Time Condition</b>	<p>Select time condition for Call Forward Unconditional. CFU takes effect only during the selected time condition. The available time conditions are “Office Time”, “Out of Office Time”, “Holiday”, “Out of Holiday”, “Out of Office Time or Holiday” and “Specific”.</p> <p><b>Note:</b></p> <ul style="list-style-type: none"> <li>• “Specific” has higher priority to “Office Times” if there is a conflict in terms of time period.</li> <li>• Specific Time can be configured in the Specific Time tab.</li> <li>• Office Time and Holiday can be configured in <b>System Settings→Time Settings→Office Time/Holiday</b> page.</li> </ul>
<b>Call Forward No Answer</b>	<p>Configure the Call Forward No Answer target number. If not configured, the Call Forward No Answer feature is deactivated. The default setting is deactivated.</p>
<b>CFN Time Condition</b>	<p>Select time condition for Call Forward No Answer. The available time conditions are “Office Time”, “Out of Office Time”, “Holiday”, “Out of Holiday”, “Out of Office Time or Holiday” and “Specific”.</p> <p><b>Notes:</b></p> <ul style="list-style-type: none"> <li>• “Specific” has higher priority to “Office Times” if there is a conflict in terms of time period.</li> <li>• Specific Time can be configured in the Specific Time tab.</li> <li>• Office Time and Holiday can be configured in <b>System Settings→Time Settings→Office Time/Holiday</b> page.</li> </ul>
<b>Call Forward Busy</b>	<p>Configure the Call Forward Busy target number. If not configured, the Call Forward Busy feature is deactivated. The default setting is deactivated.</p>
<b>CFB Time Condition</b>	<p>Select time condition for Call Forward Busy. The available time conditions are “Office Time”, “Out of Office Time”, “Holiday”, “Out of Holiday”, “Out of Office Time or Holiday” and “Specific”.</p> <p><b>Notes:</b></p> <ul style="list-style-type: none"> <li>• “Specific” has higher priority to “Office Times” if there is a conflict in terms of time period.</li> <li>• Specific Time can be configured in the Specific Time tab.</li> <li>• Office Time and Holiday can be configured in <b>System Settings→Time Settings→Office Time/Holiday</b> page.</li> </ul>
<b>CC Settings</b>	
<b>Enable CC</b>	<p>If enabled, UCM6510 will automatically alert this extension when a called party is available, given that a previous call to that party failed for some reason.</p>



Ring Simultaneously	
<b>Ring Simultaneously</b>	<p>Enable this option to have an external number ring simultaneously along with the extension.</p> <p>If a register trunk is used for outbound, the register number will be used to be displayed for the external number as caller ID number.</p>
<b>External Number</b>	Set the external number to be rang simultaneously. '-' is the connection character which will be ignored.
<b>Time Condition for Ring Simultaneously</b>	Ring the external number simultaneously along with the extension on the basis of this time condition.
Hotline	
<b>Enable Hotline</b>	If enabled, hotline dialing plan will be activated, a pre-configured number will be used based on the selected Hotline Type.
<b>Hotline Number</b>	Configure the Hotline Number
<b>Hotline Type</b>	<p>Configure the Hotline Type:</p> <ul style="list-style-type: none"> <li>• <b>Immediate Hotline:</b> When the phone is off-hook, UCM6510 will immediately dial the preset number</li> <li>• <b>Delay Hotline:</b> When the phone is off-hook, if there is no dialing within 5 seconds, UCM6510 will dial the preset number.</li> </ul>
Other Settings	
<b>Ring Timeout</b>	<p>Configure the number of seconds to ring the user before the call is forwarded to voicemail (voicemail is enabled) or hang up (voicemail is disabled). If not specified, the default ring timeout is 60 seconds on the UCM6510, which can be configured in the global ring timeout setting under Web GUI→<b>PBX Settings</b>→<b>General Settings</b>: General Preference. The valid range is between 5 seconds and 600 seconds.</p> <p><b>Note:</b></p> <p>If the end point also has a ring timeout configured, the actual ring timeout used is the shortest time set by either device.</p>
<b>Auto Record</b>	Enable automatic recording for the calls using this extension. The default setting is disabled. The recording files can be accessed under Web GUI→ <b>CDR</b> → <b>Recording Files</b> .
<b>Skip Trunk Auth</b>	<ul style="list-style-type: none"> <li>• If set to "Yes", users can skip entering the password when making outbound calls.</li> <li>• If set to "By Time", users can skip entering the password when making outbound calls during the selected time condition.</li> </ul>



	<ul style="list-style-type: none"> <li>If set to “No”, users will be asked to enter the password when making outbound calls.</li> </ul>
<b>Time Condition for Skip Trunk Auth</b>	If “Skip Trunk Auth” is set to “By Time”, select a time condition during which users can skip entering password when making outbound calls.
<b>Dial Trunk Password</b>	Configure personal password when making outbound calls via trunk.
<b>Enable LDAP</b>	If enabled, this extension will be added to LDAP Phonebook PBX list; if disabled, this extension will be skipped when creating LDAP Phonebook.
<b>Music On Hold</b>	Select which Music On Hold playlist to suggest to extension when putting the active call on hold.
<b>Call Duration Limit</b>	Configure the maximum duration of call-blocking.

**Table 42: FXS Extension Configuration Parameters – Specific Time**

Specific Time	
<b>Time Condition</b>	Click to add Time Condition to configure specific time for this extension.

## Batch Add Extensions

### Batch Add SIP Extensions

To create multiple SIP extensions quickly, users can select "Batch" for the Select Add Method option during the extension creation process.

**Table 43: Batch Add SIP Extension Parameters**

General	
<b>Start Extension</b>	Configure the starting extension number of the batch of extensions to be added.
<b>Create Number</b>	Specify the number of extensions to be added. The default setting is 5.
<b>Extension Incrementation</b>	Specify how much to increment each additional extension (e.g., if the value is 2, the extensions will be 1000, 1002, 1004, etc.). Note: Supports up to 3 characters.
<b>Permission</b>	<p>Assign permission level to the user. The available permissions are “Internal”, “Local”, “National” and “International” from the lowest level to the highest level. The default setting is “Internal”.</p> <p><b>Note:</b> Users need to have the same level as or higher level than an outbound rule’s privilege in order to make outbound calls using this rule. If the outbound rule privilege is disabled, this option will not take effect.</p>
<b>Voicemail</b>	Configure Voicemail. There are three valid options and the default option is "Enable Local Voicemail".



	<ul style="list-style-type: none"> <li>• <b>Disable Voicemail:</b> Disable Voicemail.</li> <li>• <b>Enable Local Voicemail:</b> Enable voicemail for the user.</li> <li>• <b>Enable Remote Voicemail:</b> Forward the notify message from remote voicemail system for the user, and the local voicemail will be disabled. <b>Note:</b> Remote voicemail feature is used only for Infomatec (Brazil).</li> </ul>
<b>SIP/IAX Password</b>	<p>Configure the SIP/IAX password for the users. Two options are available to create password for the batch of extensions.</p> <ul style="list-style-type: none"> <li>• <b>Random Password (enter letter 'r')</b> = A random secure password will be automatically generated. It is recommended to use this password for security purpose.</li> <li>• <b>Enter a password to be used on all the extensions in the batch.</b></li> </ul>
<b>Voicemail Password</b>	<p>Configure the password to access the extension's voicemail. A randomly generated password is used by default and is highly recommended for security. Only digits are supported.</p>
<b>CallerID Number</b>	<p>Configure CallerID Number when adding Batch Extensions.</p> <ul style="list-style-type: none"> <li>• <b>Use Extension as Number (enter letter 'e')</b> Users can choose to use the extension number as CallerID.</li> <li>• <b>Use as Number</b> Users can choose to set a specific number instead of using the extension number as CallerID.</li> </ul>
<b>Ring Timeout</b>	<p>Configure the number of seconds to ring the user before the call is forwarded to voicemail (voicemail is enabled) or hang up (voicemail is disabled). If not specified, the default ring timeout is 60 seconds on the UCM6510, which can be configured in the global ring timeout setting under Web GUI→<b>Internal Options</b>: General Preference. The valid range is between 5 seconds and 600 seconds.</p> <p><b>Note:</b> If the end point also has a ring timeout configured, the actual ring timeout used is the shortest time set by either device.</p>
<b>Auto Record</b>	<p>Enable automatic recording for the calls using this extension. The default setting is disabled. The recording files will be saved in external storage if plugged in and can be accessed under Web GUI→<b>CDR</b>→<b>Recording Files</b>.</p>
<b>Skip Voicemail Password Verification</b>	<p>If enabled, users can skip password verification when dialing in via the My Voicemail feature code. This option is disabled by default.</p>
<b>Music On Hold</b>	<p>Select which Music On Hold playlist to suggest to extensions when putting them on hold.</p>
<b>Enable LDAP</b>	<p>If enabled, the batch added extensions will be added to LDAP Phonebook PBX list; if disabled, the batch added extensions will be skipped when creating LDAP Phonebook.</p>



<b>Enable WebRTC Support</b>	If enabled, extensions will be able to login to user portal and use Web RTC features.
<b>Call Duration Limit</b>	Configure the maximum duration of call-blocking.
<b>SIP Settings</b>	
<b>NAT</b>	Use NAT when the PBX is on a public IP communicating with devices hidden behind NAT (e.g., broadband router). If there is one-way audio issue, usually it is related to NAT configuration or Firewall's support of SIP and RTP ports. The default setting is enabled.
<b>Can Direct Media</b>	By default, the PBX will route the media steams from SIP endpoints through itself. If enabled, the PBX will attempt to negotiate with the endpoints to route the media stream directly. It is not always possible for the PBX to negotiate endpoint-to-endpoint media routing. The default setting is "No".
<b>DTMF Mode</b>	Select DTMF mode for the user to send DTMF. The default setting is "RFC4733". If "Info" is selected, SIP INFO message will be used. If "Inband" is selected, 64-kbit codec PCMU and PCMA are required. When "Auto" is selected, RFC4733 will be used if offered, otherwise "Inband" will be used.
<b>Enable Keep-alive</b>	If enabled, empty SDP packet will be sent to the SIP server periodically to keep the NAT port open. The default setting is "Yes".
<b>Keep-alive Frequency</b>	Configure the number of seconds for the host to be up for Keep-alive. The default setting is 60 seconds.
<b>TEL URI</b>	If the end device/phone has an assigned PSTN telephone number, this field should be set to "User=Phone". Then a "User=Phone" parameter will be attached to the Request-Line and TO header in the SIP request to indicate the E.164 number. If set to "Enable", "Tel:" will be used instead of "SIP:" in the SIP request. The default setting is disabled.
<b>Concurrent Registrations</b>	The maximum allowed number of endpoint registrations to this extension. Default value is 1.
<b>Other Settings</b>	
<b>SRTP</b>	Enable SRTP for the call. The default setting is "No".
<b>Fax Mode</b>	<p>Select Fax mode for this user. The default setting is "None".</p> <ul style="list-style-type: none"> <li>• <b>None:</b> Disable Fax.</li> <li>• <b>Fax Detect:</b> Fax signal from the user/trunk during the call can be detected and the received Fax will be sent to the Email address configured for this extension. If no Email address can be found for the user, the Fax will be sent to the default Email address configured in Fax setting page under Web GUI→Call Features→Fax/T.38.</li> </ul> <p><b>Note:</b> If enabled, Fax Pass-through cannot be used.</p>
<b>ACL Policy</b>	This option controls how the extension can be used on devices within



	diverse types of network. <ul style="list-style-type: none"> <li>• <b>Allow All</b> Device in any network can register this extension.</li> <li>• <b>Local Network Address</b> Only IP addresses in the configured network segments can register to this extension.</li> </ul>
<b>Enable T.38 UDPTL</b>	Enable or disable T.38 UDPTL Support.
<b>Skip Trunk Auth</b>	If enabled, users will not need enter the “PIN Set” required by the outbound rule to make outbound calls. The default setting is “No”.
<b>Codec Preference</b>	Select audio and video codec for the extension. The available codecs are: PCMU, PCMA, GSM, AAL2-G.726-32, G.722, G.729, G.723, OPUS, ILBC, ADPCM, LPC10, H.264, H.265, H.263 and H.263p. In the selected codec list, users can click on UP or DOWN arrow to adjust the order for the codec priority.

### Batch Add IAX Extensions

Under Web GUI→**Extension/Trunk**→**Extensions**, click on "Add" and select extension type as IAX extension, and “add method” as Batch.

Table 44: Batch Add IAX Extension Parameters

General	
<b>Start Extension</b>	Configure the starting extension number of the batch of extensions to be added.
<b>Create Number</b>	Specify the number of extensions to be added. The default setting is 5.
<b>Permission</b>	<p>Assign permission level to the user. The available permissions are “Internal”, “Local”, “National” and “International” from the lowest level to the highest level. The default setting is “Internal”.</p> <p><b>Note:</b> Users need to have the same level as or higher level than an outbound rule’s privilege in order to make outbound calls from this rule.</p>
<b>Voicemail</b>	<p>Configure Voicemail. There are three valid options and the default option is "Enable Local Voicemail".</p> <ul style="list-style-type: none"> <li>• <b>Disable Voicemail:</b> Disable Voicemail.</li> <li>• <b>Enable Local Voicemail:</b> Enable voicemail for the user.</li> </ul>
<b>SIP/IAX Password</b>	<p>Configure the SIP/IAX password for the users. Three options are available to create password for the batch of extensions.</p> <ul style="list-style-type: none"> <li>• Random Password (enter letter ‘r’) = A random secure password will be automatically generated. It is recommended to use this password</li> </ul>



	<p>for security purpose.</p> <ul style="list-style-type: none"> <li>• Enter a password to be used on all the extensions in the batch.</li> </ul>
<b>Voicemail Password</b>	<p>Configure the password to access the extension's voicemail. A randomly generated password is used by default and is highly recommended for security. Only digits are supported.</p>
<b>Ring Timeout</b>	<p>Configure the number of seconds to ring the user before the call is forwarded to voicemail (voicemail is enabled) or hang up (voicemail is disabled). If not specified, the default ring timeout is 60 seconds on the UCM6510, which can be configured in the global ring timeout setting under Web GUI→<b>PBX Settings</b>→<b>General Settings</b>: General Preference. The valid range is between 5 seconds and 600 seconds.</p> <p><b>Note:</b> If the end point also has a ring timeout configured, the actual ring timeout used is the shortest time set by either device.</p>
<b>Auto Record</b>	<p>Enable automatic recording for the calls using this extension. The default setting is disabled. The recording files can be accessed under Web GUI→<b>CDR</b>→<b>Recording Files</b>.</p>
<b>Skip Voicemail Password Verification</b>	<p>If enabled, users can skip password verification when dialing in via the My Voicemail feature code. This option is disabled by default.</p>
<b>Music On Hold</b>	<p>Select which Music On Hold playlist to suggest to extensions when putting them on hold.</p>
<b>Call Duration Limit</b>	<p>Configure the maximum duration of call-blocking.</p>
<b>Enable LDAP</b>	<p>If enabled, the batch added extensions will be added to LDAP Phonebook PBX list; if disabled, the batch added extensions will be skipped when creating LDAP Phonebook.</p>
<b>IAX Settings</b>	
<b>Max Number of Calls</b>	<p>Configure the maximum number of calls allowed for each remote IP address.</p>
<b>Require Call Token</b>	<p>Configure to enable/disable requiring call token. If set to "Auto", it might lock out users who depend on backward compatibility when peer authentication credentials are shared between physical endpoints. The default setting is "Yes".</p>
<b>Other Settings</b>	
<b>SRTP</b>	<p>Enable SRTP for the call. The default setting is "No".</p>
<b>Fax Mode</b>	<p>Select Fax Mode for this user. The default setting is "None".</p> <ul style="list-style-type: none"> <li>• <b>None:</b> Disable Fax.</li> <li>• <b>Fax Detect:</b> Fax signal from the user/trunk during the call can be detected and the received Fax will be sent to the Email address</li> </ul>






	configured for this extension. If no Email address can be found for the user, the Fax will be sent to the default Email address configured in Fax setting page under Web GUI→ <b>Call Features</b> → <b>Fax/T.38</b> .
<b>ACL Policy</b>	<p>This option controls how the extension can be used on devices within diverse types of network.</p> <ul style="list-style-type: none"> <li>• <b>Allow All</b> Device in any network can register this extension.</li> <li>• <b>Local Network Address</b> Only IP addresses in the configured network segments can register to this extension.</li> </ul>
<b>Skip Trunk Auth</b>	If enable “All”, users do not need to enter password when making an outbound call. If enable “Follow Me”, the call can dial out via follow me without password.
<b>Codec Preference</b>	Select audio and video codec for the extension. The available codecs are: PCMU, PCMA, GSM, AAL2-G.726-32, G.722, G.729, G.723, ILBC, ADPCM, LPC10, H.264, H.265, H.263 and H.263p.

## Batch Extension Resetting Functionality

To reset multiple extensions to default settings, select the extensions on the main **Extension/Trunk**→**Extensions** page and click on the Reset button. Once reset, all settings except for Concurrent Registrations will be reverted to default. User voicemail password will be randomized again, and user voicemail prompts and recordings will be deleted. The settings for the extension user in the User Management page will also be reverted to default except for usernames and custom privileges.

## Search and Edit Extension

All the UCM6510 extensions are listed under Web GUI→**Extension/Trunk**→**Extensions**, with status, Extension, CallerID Name, Technology (SIP, IAX and FXS), IP and Port. Each extension has a checkbox for users to “Edit Selected Extensions” or “Delete Selected Extensions”. Also, options “Edit” , “Reboot” , “Delete”  and reset are available per extension. User can search an extension by specifying the extension number to find an extension quickly.





Extensions												
<input type="checkbox"/> + Add <input type="checkbox"/> Edit <input type="checkbox"/> Delete <input type="button" value="Import"/> <input type="button" value="Export"/> <input type="button" value="E-mail Notification"/> <input type="button" value="Follow Me Options"/> <input type="text" value="Enter Extension Number or CallerID Name"/> <input type="button" value="Search"/>												
<input type="checkbox"/>	Status	Presence Status	Extension	CallerID Name	Message	Terminal Type	IP and Port	Email Status	Options			
<input type="checkbox"/>	Idle	Available	1000		Messages: 0/0/0	SIP	192.168.5.143:5061					
<input type="checkbox"/>	Unavailable	Available	1001		Messages: 0/0/0	SIP	--					

**Figure 84: Manage Extensions**

- **Status**

Users can see the following icon for each extension to indicate the SIP status.

- **Green:** Free
- **Blue:** Ringing
- **Yellow:** In Use
- **Grey:** Unavailable

- **Edit single extension**

Click on to start editing the extension parameters.

- **Reset single extension**

Click on to reset the extension parameters to default (except concurrent registration).

Other settings will be restored to default in **Maintenance**→**User Management**→**User Information** except username and permissions and delete the user voicemail prompt and voice messages.

- **Reboot the user**

Click on to send NOTIFY reboot event to the device which has an UCM6510 extension already registered. To successfully reboot the user, “Zero Config” needs to be enabled on the UCM6510 Web GUI→**Value-added Features**→**Zero Config**→**Auto Provisioning Settings**.

- **Delete selected extensions**

Click on the button to delete a single extension. Users can also select multiple extensions and click on the Delete button to delete several extensions at once.

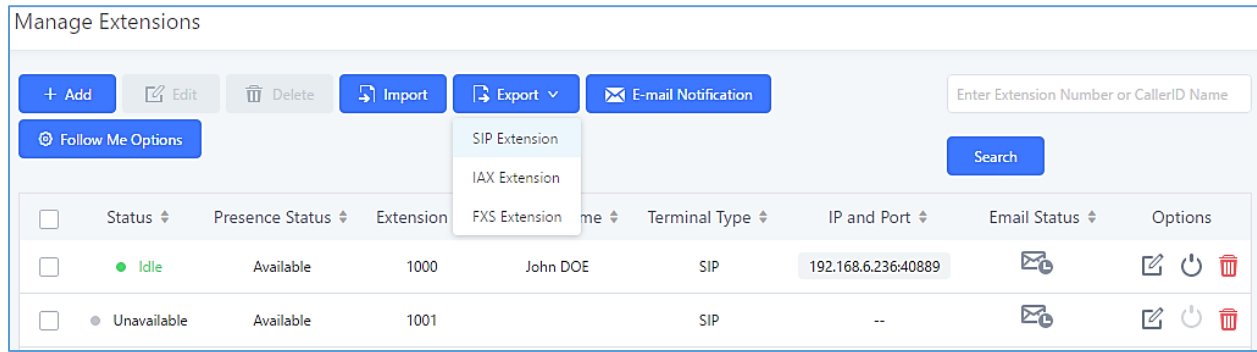
- **Modify selected extensions**

Select the checkbox for the extension(s). Then click on “Modify Selected Extensions” to edit the extensions in a batch.



## Export Extensions

UCM extensions can be exported to a CSV file. Different extension types (SIP, IAX, FXS) cannot be exported to the same CSV file. To export extensions, click on the Export button and select the extension type to export.



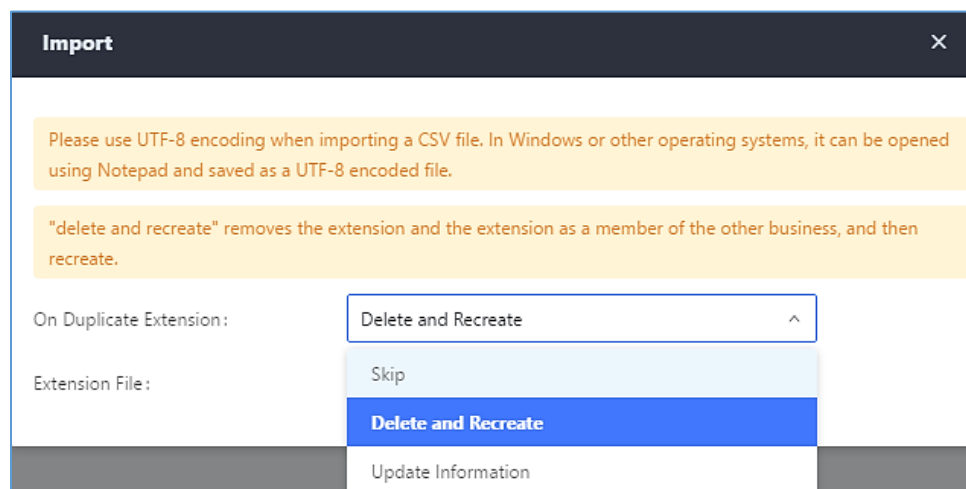
**Figure 85: Export Extensions**

Users can also use the exported CSV file to use as a template to manually edit extension information.

## Import Extensions

The capability to import extensions to the UCM6510 provides users flexibility to batch add extensions with similar or different configurations quickly.

1. Export extension csv file from the UCM6510 by clicking on “Export Extensions” button.
2. Fill up the extension information you would like in the exported csv template.
3. Click on “Import Extensions” button. The following dialog will be prompted.



**Figure 86: Export Extensions**



4. Select the option in “On Duplicate Extension” to define how the duplicate extension(s) in the imported csv file should be treated by the PBX.
  - Skip: Duplicate extensions in the csv file will be skipped. The PBX will keep the current extension information as previously configured without change.
  - Delete and Recreate: The current extension previously configured will be deleted and the duplicate extension in the csv file will be loaded to the PBX.
  - Update Information: The current extension previously configured in the PBX will be kept. However, if the duplicate extension in the csv file has different configuration for any options, it will override the configuration for those options in the extension.
5. Click on “choose file to upload” to select csv file from local directory in the PC for uploading.
6. Click on “Save” to import the csv file.
7. Click on “Apply Changes” to apply the imported file on the UCM6510.

**Note:** The imported file should look like the following:

A	B	C	D	E	F	G	H	I	J	K	L	M	N
Extension	Technology	Enable Voicemail	CallerID	SIP/IAX Password	Voicema	Skip Voicemail Password Verification	Ring Timeout	Auto Record	SRTP	Fax Mode	Strategy	Local Subnet 1	Local Sub
1000	SIP	yes	1000	admin123	61783	no		no	no	None	Allow All		
1001	SIP	yes	1001	admin123	955921	no		no	no	None	Allow All		
1002	SIP	yes	1002	admin123	269824	no		no	no	None	Allow All		
1003	SIP	yes	1003	admin123	363196	no		no	no	None	Allow All		
1004	SIP	yes	1004	admin123	12860	no		no	no	None	Allow All		

Figure 87: Import File

Table 45: SIP Extensions Imported File Example

Field	Supported values
<b>Extension</b>	Digits
<b>Technology</b>	SIP/SIP(WebRTC)
<b>Enable Voicemail</b>	yes/no/remote
<b>CallerID Number</b>	Digits
<b>SIP/IAX Password</b>	Alphanumeric characters
<b>Voicemail Password</b>	Digits
<b>Skip Voicemail Password Verification</b>	yes/no
<b>Ring Timeout</b>	Empty/ 3 to 600 (in second)
<b>SRTP</b>	yes/no
<b>Fax Mode</b>	None/Fax Detection
<b>Strategy</b>	Allow All/Local Subnet Only/A Specific IP Address
<b>Local Subnet 1</b>	IP address/Mask
<b>Local Subnet 2</b>	IP address/Mask
<b>Local Subnet 3</b>	IP address/Mask
<b>Local Subnet 4</b>	IP address/Mask



<b>Local Subnet 5</b>	IP address/Mask
<b>Local Subnet 6</b>	IP address/Mask
<b>Local Subnet 7</b>	IP address/Mask
<b>Local Subnet 8</b>	IP address/Mask
<b>Local Subnet 9</b>	IP address/Mask
<b>Local Subnet 10</b>	IP address/Mask
<b>Specific IP Address</b>	IP address
<b>Skip Trunk Auth</b>	yes/no/bytime
<b>Codec Preference</b>	PCMU,PCMA,GSM,G.726,G.722,G.729,H.264, H.265, ILBC, AAL2-G.726-32, ADPCM, G.723, H.263, H.263p, vp8, opus
<b>Permission</b>	Internal/Local/National/International
<b>NAT</b>	yes/no
<b>DTMF Mode</b>	RFC4733/info/inband/auto
<b>Insecure</b>	Port
<b>Enable Keep-alive</b>	Yes/no
<b>Keep-alive Frequency</b>	Value from 1-3600
<b>AuthID</b>	Alphanumeric value without special characters
<b>TEL URI</b>	Disabled/user=phone/enabled
<b>Call Forward Busy</b>	Digits
<b>Call Forward No Answer</b>	Digits
<b>Call Forward Unconditional</b>	Digits
<b>Support Hot-Desking Mode</b>	Yes/no
<b>Dial Trunk Password</b>	Digits
<b>Disable This Extension</b>	Yes/no
<b>CFU Time Condition</b>	All time/Office time/out of office time/holiday/out of holiday/out of office time or holiday/specific time
<b>CFN Time Condition</b>	All time/Office time/out of office time/holiday/out of holiday/out of office time or holiday/specific time
<b>CFB Time Condition</b>	All time/Office time/out of office time/holiday/out of holiday/out of office time or holiday/specific time
<b>Music On Hold</b>	Default/ringbacktone_default
<b>CC Agent Policy</b>	If CC is disabled use: never If CC is set to normal use: generic If CC is set to trunk use: native
<b>CC Monitor Policy</b>	Generic/never
<b>CCBS Available Timer</b>	3600/4800
<b>CCNR Available Timer</b>	3600/7200



<b>CC Offer Timer</b>	60/120
<b>CC Max Agents</b>	Value from 1-999
<b>CC Max Monitors</b>	Value from 1-999
<b>Ring simultaneously</b>	Yes/no
<b>External Number</b>	Digits
<b>Time Condition for Ring Simultaneously</b>	All time/Office time/out of office time/holiday/out of holiday/out of office time or holiday/specific time
<b>Time Condition for Skip Trunk Auth</b>	All time/Office time/out of office time/holiday/out of holiday/out of office time or holiday/specific time
<b>Enable LDAP</b>	Yes/no
<b>Enable T.38 UDPTL</b>	Yes/no
<b>Max Contacts</b>	Values from 1-10
<b>Enable WebRTC</b>	Yes/no
<b>Alert-Info</b>	None/Ring 1/Ring2/Ring3/Ring 4/Ring 5/Ring 6/Ring 7/ Ring 8/Ring 9/Ring 10/bellcore-dr1/bellcore-dr2/ bellcore-dr3/ bellcore-dr4/ bellcore-dr5/custom
<b>Do Not Disturb</b>	Yes/no
<b>DND Time Condition</b>	All time/Office time/out of office time/holiday/out of holiday/out of office time or holiday/specific time
<b>Custom Auto answer</b>	Yes/no
<b>Do Not Disturb Whitelist</b>	Empty/digits
<b>User Password</b>	Alphanumeric characters.
<b>First Name</b>	Alphanumeric without special characters.
<b>Last Name</b>	Alphanumeric without special characters.
<b>Email Address</b>	Email address
<b>Language</b>	Default/en/zh
<b>Phone Number</b>	Digits
<b>Call-Barging Monitor</b>	Extensions allowed to call barging
<b>Seamless Transfer Members</b>	Extensions allowed to seamless transfer

**Table 46: IAX extensions Imported File Example**

<b>Field</b>	<b>Supported values</b>
<b>Extension</b>	Digits
<b>Technology</b>	IAX
<b>Enable Voicemail</b>	yes/no
<b>CallerID Number</b>	Digits



<b>SIP/IAX Password</b>	Alphanumeric characters
<b>Voicemail Password</b>	Digits
<b>Skip Voicemail Password Verification</b>	yes/no
<b>Ring Timeout</b>	Empty/ 3 to 600 (in second)
<b>SRTP</b>	yes/no
<b>Fax Mode</b>	None/Fax Detection
<b>Strategy</b>	Allow All/Local Subnet Only/A Specific IP Address
<b>Local Subnet 1</b>	IP address/Mask
<b>Local Subnet 2</b>	IP address/Mask
<b>Local Subnet 3</b>	IP address/Mask
<b>Local Subnet 4</b>	IP address/Mask
<b>Local Subnet 5</b>	IP address/Mask
<b>Local Subnet 6</b>	IP address/Mask
<b>Local Subnet 7</b>	IP address/Mask
<b>Local Subnet 8</b>	IP address/Mask
<b>Local Subnet 9</b>	IP address/Mask
<b>Local Subnet 10</b>	IP address/Mask
<b>Specific IP Address</b>	IP address
<b>Skip Trunk Auth</b>	yes/no/bytime
<b>Codec Preference</b>	PCMU,PCMA,GSM,G.726,G.722,G.729,H.264,H.265,ILBC,AAL2-G.726-32,ADPCM,G.723,H.263,H.263p,vp8,opus.
<b>Permission</b>	Internal/Local/National/International
<b>NAT</b>	yes/no
<b>Call Forward Busy</b>	Digits
<b>Call Forward No Answer</b>	Digits
<b>Call Forward Unconditional</b>	Digits
<b>Require Call Token</b>	Yes/no/auto
<b>Max Number of Calls</b>	Values from 1-512
<b>Dial Trunk Password</b>	Digits
<b>Disable This Extension</b>	Yes/no
<b>CFU Time Condition</b>	All time/Office time/out of office time/holiday/out of holiday/out of office time or holiday/specific time
<b>CFN Time Condition</b>	All time/Office time/out of office time/holiday/out of holiday/out of office time or holiday/specific time
<b>CFB Time Condition</b>	All time/Office time/out of office time/holiday/out of holiday/out of office time or holiday/specific time



<b>Music On Hold</b>	Default/ringbacktone_default
<b>Ring simultaneously</b>	Yes/no
<b>External Number</b>	Digits
<b>Time Condition for Ring Simultaneously</b>	All time/Office time/out of office time/holiday/out of holiday/out of office time or holiday/specific time
<b>Time Condition for Skip Trunk Auth</b>	All time/Office time/out of office time/holiday/out of holiday/out of office time or holiday/specific time
<b>Enable LDAP</b>	Yes/no
<b>Limit Max time (s)</b>	Empty
<b>Do Not Disturb</b>	Yes/no
<b>DND Time Condition</b>	All time/Office time/out of office time/holiday/out of holiday/out of office time or holiday/specific time
<b>Do Not Disturb Whitelist</b>	Empty/digits
<b>User Password</b>	Alphanumeric characters.
<b>First Name</b>	Alphanumeric without special characters.
<b>Last Name</b>	Alphanumeric without special characters.
<b>Email Address</b>	Email address
<b>Language</b>	Default/en/zh
<b>Phone Number</b>	Digits
<b>Call-Barging Monitor</b>	Extensions allowed to call barging
<b>Seamless Transfer Members</b>	Extensions allowed to seamless transfer

Table 47: FXS extensions Imported File Example

Field	Supported values
<b>Extension</b>	Digits
<b>Technology</b>	FXS
<b>Analog Station</b>	FXS1/FXS2
<b>Enable Voicemail</b>	yes/no
<b>CallerID Number</b>	Digits
<b>Voicemail Password</b>	Digits
<b>Skip Voicemail Password Verification</b>	yes/no
<b>Ring Timeout</b>	Empty/ 3 to 600 (in second)
<b>Auto Record</b>	yes/no
<b>Fax Mode</b>	None/Fax Detection
<b>Skip Trunk Auth</b>	Yes/no/bytime
<b>Permission</b>	Internal/Local/National/International

<b>Call Forward Busy</b>	Digits
<b>Call Forward No Answer</b>	Digits
<b>Call Forward Unconditional</b>	Digits
<b>Call Waiting</b>	Yes/no
<b>Use # as SEND</b>	Yes/no
<b>RX Gain</b>	Values from -30→6
<b>TX Gain</b>	Values from -30→6
<b>MIN RX Flash</b>	Values from: 30 – 1000
<b>MAX RX Flash</b>	Values from: 40 – 2000
<b>Enable Polarity Reversal</b>	Yes/no
<b>Echo Cancellation</b>	On/Off/32/64/128/256/512/1024
<b>3-Way Calling</b>	Yes/no
<b>Send CallerID After</b>	½
<b>Dial Trunk Password</b>	Digits
<b>Disable This Extension</b>	Yes/no
<b>CFU Time Condition</b>	All time/Office time/out of office time/holiday/out of holiday/out of office time or holiday/specific time
<b>CFN Time Condition</b>	All time/Office time/out of office time/holiday/out of holiday/out of office time or holiday/specific time
<b>CFB Time Condition</b>	All time/Office time/out of office time/holiday/out of holiday/out of office time or holiday/specific time
<b>Music On Hold</b>	Default/ringbacktone_default
<b>CC Agent Policy</b>	If CC is disabled use: never If CC is set to normal use: generic If CC is set to trunk use: native
<b>CC Monitor Policy</b>	Generic/never
<b>CCBS Available Timer</b>	3600/4800
<b>CCNR Available Timer</b>	3600/7200
<b>CC Offer Timer</b>	60/120
<b>CC Max Agents</b>	Value from 1-999
<b>CC Max Monitors</b>	Value from 1-999
<b>Ring simultaneously</b>	Yes/no
<b>External Number</b>	Digits
<b>Time Condition for Ring Simultaneously</b>	All time/Office time/out of office time/holiday/out of holiday/out of office time or holiday/specific time
<b>Time Condition for Skip Trunk Auth</b>	All time/Office time/out of office time/holiday/out of holiday/out of office time or holiday/specific time





<b>Enable LDAP</b>	Yes/no
<b>Enable Hotline</b>	Yes/no
<b>Hotline Type</b>	Immediate hotline/delay hotline
<b>Hotline Number</b>	Digits
<b>Limit Max time (s)</b>	Empty
<b>Do Not Disturb</b>	Yes/no
<b>DND Time Condition</b>	All time/Office time/out of office time/holiday/out of holiday/out of office time or holiday/specific time
<b>Do Not Disturb Whitelist</b>	Empty/digits
<b>User Password</b>	Alphanumeric characters.
<b>First Name</b>	Alphanumeric without special characters.
<b>Last Name</b>	Alphanumeric without special characters.
<b>Email Address</b>	Email address
<b>Language</b>	Default/en/zh
<b>Phone Number</b>	Digits
<b>Call-Barging Monitor</b>	Extensions allowed to call barging
<b>Seamless Transfer Members</b>	Extensions allowed to seamless transfer

The CSV file should contain all the above fields, if one of them is missing or empty, the UCM6510 will display the following error message for missing fields.

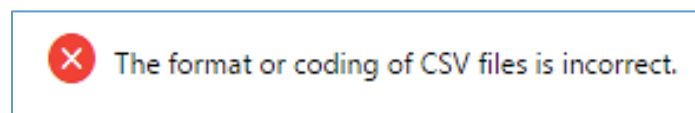


Figure 88: Import Error

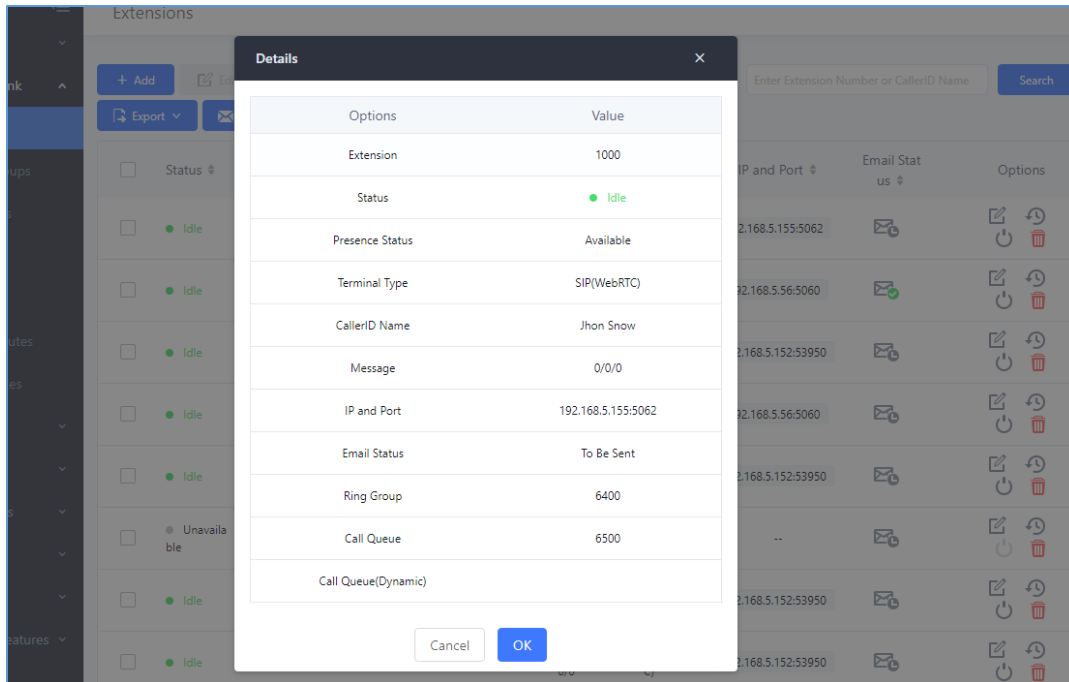
## Extension Details

Users can access the Extension Details by clicking on an extension number in the *Extensions* list page and quickly view information about it such as:

- **Extension:** Shows the Extension number.
- **Status:** Shows the status of the extension.
- **Presence status:** Indicates the Presence Status of this extension.
- **Terminal Type:** Shows the Type of the terminal using this extension (SIP, FXS...etc.).
- **Caller ID Name:** Reveals the Caller ID Name configured on the extension.
- **Messages:** Shows the messages stats.
- **IP and Port:** The IP address and the ports of the device using the extension.
- **Email status:** Show the Email status (sent, to be sent...etc.).
- **Ring Group:** Indicates the ring groups that this extension belongs to.



- **Call Queue:** Indicates the Cal Queues that this extension belongs to.
- **Call Queue (Dynamic):** Indicates the Call Queues that this extension belongs to as a dynamic agent.

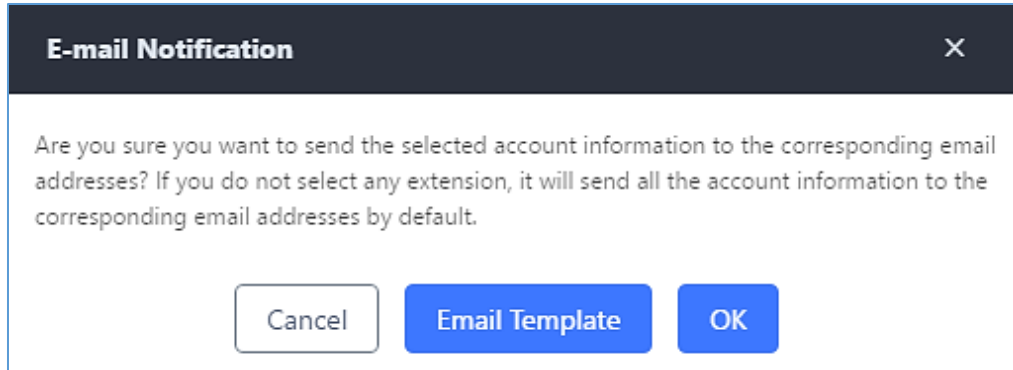


**Figure 89 : Extension Details**

## E-mail Notification

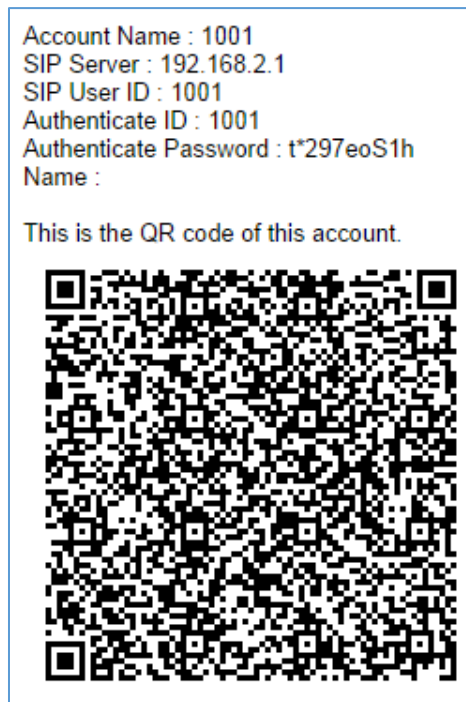
Users can request for their SIP account information via email. The system administrator can select the extensions to send account information emails to and press the Email Notification button in the Extensions page.

When click on “E-mail Notification” button, the following message will be prompted in the web page. Click on OK to confirm sending the account information to all users’ Email addresses. After clicking the button, the following prompt will appear:



**Figure 90: E-mail Notification Prompt Information**

The selected users will receive emails containing account registration information, LDAP configuration, and QR codes for quick setup on mobile apps.



**Figure 91: E-mail Notification: Account Registration Information and QR Code**



Figure 92: E-mail Notification LDAP Client Information and QR Code

### Multiple Registrations per Extension

UCM6510 supports multiple registrations per extension so that users can use the same extension on devices in different locations.



Figure 93: Multiple Registrations per Extension

This feature can be enabled by configuring option “Concurrent Registrations” under Web GUI → Extension/Trunk → Edit Extension. The default value is 1 for security purposes. Maximum is 10.

Edit Extension: 1000 Save

**Basic Settings**    Media    Features    Specific Time    Follow Me

---

**General**

* Extension:	<input type="text" value="1000"/>	CallerID Number:	<input type="text"/>
* Permission:	<input type="text" value="Internal"/>	* SIP/IAX Password:	<input type="text" value="DGc7BjoG"/>
AuthID:	<input type="text"/>	Enable Voicemail:	<input checked="" type="checkbox"/>
* Voicemail Password:	<input type="text" value="791020"/>	Skip Voicemail Password V...:	<input type="checkbox"/>
Enable Keep-alive:	<input type="checkbox"/>	* Keep-alive Frequency:	<input type="text" value="60"/>
Disable This Extension:	<input type="checkbox"/>		

**User Settings**

First Name:	<input type="text" value="John"/>	Last Name:	<input type="text" value="DOE"/>
Email Address:	<input type="text" value="mbaomar@grandstream.com"/>	* User Password:	<input type="text" value="*****"/>
* Language:	<input type="text" value="Default"/>	* Concurrent Registration...:	<input type="text" value="3"/>
Mobile Phone Number:	<input type="text"/>		

**Figure 94: Extension - Concurrent Registration**

## SMS Message Support

The UCM6510 provides built-in SIP SMS message support. For SIP end devices such as Grandstream GXP or GXV phones that supports SIP message, after an UCM6510 account is registered on the end device, the user can send and receive SMS message. Please refer to the end device documentation on how to send and receive SMS message.

SMS Message support is a new feature added since firmware 1.0.10.x.





**Figure 95: SMS Message Support**

## EXTENSION GROUPS

The UCM6510 extension group feature allows users to assign extensions to different groups to better manage the configurations on the PBX. For example, when configuring "Enable Filter on Source Caller ID", users could select a group instead of each person's extension to assign. This feature simplifies the configuration process and helps manage and categorize the extensions for business environment.

### Configure Extension Groups

Extension group can be configured via Web GUI→**Call Features**→**Extension Groups**.

- Click on "Create New Extension Group" to create a new extension group.
- Click on  to edit the extension group.
- Click on  to delete the extension group.

Select extensions from the list on the left side to the right side.

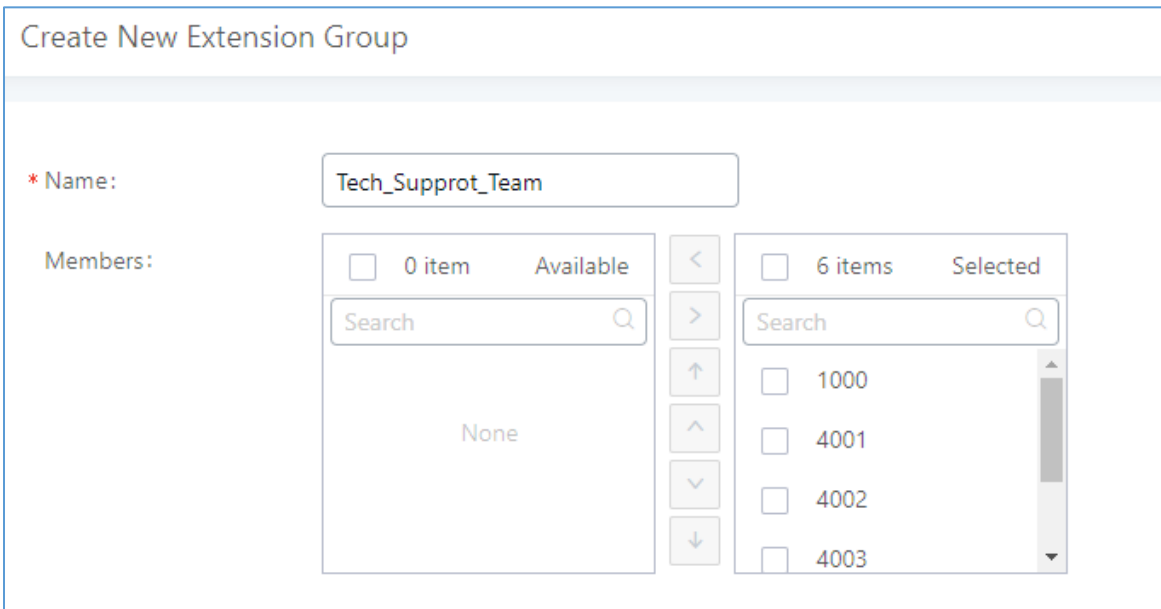


Figure 96: Edit Extension Group

Click on     in order to change the ringing priority of the members selected on the group.



## Use Extension Groups

Here is an example where the extension group can be used. Go to Web GUI → **Extension/Trunk** → **Outbound Routes** and select "Enable Filter on Source Caller ID". Both single extensions and extension groups will show up for users to select.

Edit Outbound Rule: National
Save

<p>* Calling Rule Name: <input style="width: 80%;" type="text" value="National"/></p> <p>Disable This Route: <input type="checkbox"/></p> <p>Password: <input style="width: 80%;" type="text"/></p>	<p>* Pattern: <input style="width: 80%;" type="text" value="_xxxxxxxx"/></p> <p>PIN Groups: <input style="border: none; border-bottom: 1px solid #ccc; text-align: right; font-size: 0.9em; color: #666; cursor: pointer; padding-right: 5px;" type="text" value="None"/> v</p> <p>Privilege Level: <input style="border: none; border-bottom: 1px solid #ccc; text-align: right; font-size: 0.9em; color: #666; cursor: pointer; padding-right: 5px;" type="text" value="Disable"/> v</p>
---	--

Enable Filter on Source Caller ID

Enable Filter on Source.

Available Extensions/E...

\* Custom Dynamic Ro...

**Figure 97: Select Extension Group in Outbound Route**





## ANALOG TRUNKS

To set up analog trunk on the UCM6510:

- Go to Web GUI→**Extension/Trunk**→**Analog Trunks** to add and edit analog trunks.
- Go to Web GUI→**PBX Settings**→**Interface Settings** to configure analog hardware settings.

### Analog Trunks Configuration

Go to Web GUI→**Extension/Trunk**→**Analog Trunks** to add and edit analog trunks.

- Click on “Create New Analog Trunk” to add a new analog trunk.
- Click on  to edit the analog trunk.
- Click on  to delete the analog trunk.

The analog trunk options are listed in the table below.

**Table 48: Analog Trunk Configuration Parameters**

<b>Channels</b>	Select the channel for the analog trunk.
<b>Trunk Name</b>	Specify a unique label to identify the trunk when listed in outbound routes, inbound routes and etc.
<b>Advanced Options</b>	
<b>SLA Mode</b>	Enable this option to satisfy two primary use cases, which include emulating a simple key system and creating shared extensions on a PBX. Enable SLA Mode will disable polarity reversal.
<b>Barge Allowed</b>	The barge option specifies whether or not other stations are allowed to join a call in progress on this trunk. If enabled, the other stations can press the line button to join the call. The default setting is Yes.
<b>Hold Access</b>	The hold option specifies hold permissions for this trunk. If set to “Open”, any station can place this trunk on hold and any other station is allowed to retrieve the call. If set to “Private”, only the station that places the call on hold can retrieve the call. The default setting is Yes.
<b>Enable Polarity Reversal</b>	If enabled, a polarity reversal will be marked as received when an outgoing call is answered by the remote party. For some countries, a polarity reversal is used for signaling the disconnection of a phone line and the call will be considered as “hang up” on a polarity reversal. The default setting is “No”.





<b>Polarity on Answer Delay</b>	When FXO port answers the call, FXS may send a Polarity Reversal. If this interval is shorter than the value of “Polarity on Answer Delay”, the Polarity Reversal will be ignored. Otherwise, the FXO will on-hook to disconnect the call. The default setting is 600ms.
<b>Current Disconnect Threshold (ms)</b>	This is the periodic time (in ms) that the UCM6510 will use to check on a voltage drop in the line. The default setting is 200. Valid range is 50 to 3000.
<b>Ring Timeout</b>	Configure the ring timeout (in ms). Trunk (FXO) devices must have a timeout to determine if there was a hang up before the line is answered. This value can be used to configure how long it takes before the UCM6510 considers a non-ringing line with hang up activity. Default setting is 8000.
<b>RX Gain</b>	Configure the RX gain for the receiving channel of analog FXO port. The valid range is from -12.0 (Db) to + 12.0 (Db). The default setting is 0.
<b>TX Gain</b>	Configure the TX gain for the transmitting channel of analog FXO port. The valid range is from -12.0 (Db) to + 12.0 (Db). The default setting is 0.
<b>Use CallerID</b>	Configure to enable CallerID detection. The default setting is “Yes”.
<b>Caller ID Scheme</b>	<p>Select the Caller ID scheme for this trunk.</p> <ul style="list-style-type: none"> <li>• Bellcore/Telcordia.</li> <li>• ETSI-FSK During Ringing</li> <li>• ETSI-FSK Prior to Ringing with DTAS</li> <li>• ETSI-FSK Prior to Ringing with LR</li> <li>• ETSI-FSK Prior to Ringing with RP</li> <li>• ETSI-DTMF During Ringing</li> <li>• ETSI-DTMF Prior to Ringing with DTAS</li> <li>• ETSI-DTMF Prior to Ringing with LR</li> <li>• ETSI-DTMF Prior to Ringing with RP</li> <li>• SIN 227-BT</li> <li>• NTT Japan</li> <li>• Auto Detect</li> </ul> <p>If you are not sure which scheme to choose, please select “Auto Detect”. The default setting is “Bellcore/Telcordia”.</p>
<b>Fax Mode</b>	<p>Enable to detect Fax signal from the trunk during the call and send the received Fax to the default Email address in Fax setting page under Web GUI→<b>Call Features</b>→<b>Fax/T.38</b>. The default setting is “No”.</p> <p><b>Note:</b> If enabled, Fax Pass-through cannot be used.</p>
<b>FXO Dial Delay(ms)</b>	Configure the time interval between off-hook and first dialed digit for outbound calls.
<b>Auto Record</b>	Enable automatic recording for the calls using this trunk. The default setting is disabled. The recording files are saved in external storage device if plugged in and can be accessed under Web GUI→ <b>CDR</b> → <b>Recording Files</b> .



<b>Disable This Trunk</b>	If selected, the trunk will be disabled and incoming/Outgoing calls via this trunk will not be possible.
<b>DAHDI Out Line Selection</b>	<p>This is to implement analog trunk outbound line selection strategy. Three options are available:</p> <ul style="list-style-type: none"> <li>• <b>Ascend:</b> When the call goes out from this analog trunk, it will always try to use the first idle FXO port. The port order that the call will use to go out would be port 1→port 2→port 10→port 16. Every time it will start with port 1 (if it is idle).</li> <li>• <b>Poll:</b> When the call goes out from this analog trunk, it will use the port that is not used last time. And it will always use the port in the order of port 1→2→10→16→1→2→10→16→1→2→10→16..., following the last port being used.</li> <li>• <b>Descend:</b> When the call goes out from this analog trunk, it will always try to use the last idle FXO port. The port order that the call will use to go out would be port 16→port 10→port 2→port 1. Every time it will start with port 16 (if it is idle).</li> </ul> <p>The default setting is “Ascend” mode.</p>
<b>Echo Cancellation Mode</b>	<p>The Non-Linear Processing (NLP) in echo cancellation helps to remove/suppress residual echo components that could not be removed by the LEC (Line Echo Canceller). Following modes are supported:</p> <ul style="list-style-type: none"> <li>• <b>Default:</b> Slightly reduces the amount of detected background noise.</li> <li>• <b>High Noise Level Adjustment:</b> Greatly reduces the amount of detected background noise.</li> <li>• <b>Noise Masking:</b> Injects noise to mask echo and greatly reduces the amount of detected background noise.</li> <li>• <b>White Noise Injection:</b> Injects variable amounts of white noise based on detected background noise and greatly reduces the amount of detected background noise.</li> </ul>
<b>Direct Callback</b>	<p>Allows external numbers the option to get directed to the extension that last called them.</p> <p>For Example: User 2002 has dialed external number 061234575 but they were not reachable, once they have received missed call notification on their phone, they would mostly call back the number, if the option “Direct Callback” is enabled then they will be directly bridged to user 2002 regardless of the configured inbound destination.</p>
<b>Tone Settings</b>	
<b>Busy Detection</b>	Busy Detection is used to detect far end hang up or for detecting busy



	signal. The default setting is “Yes”.
<b>Busy Tone Count</b>	If “Busy Detection” is enabled, users can specify the number of busy tones to be played before hanging up. The default setting is 2. Better results might be achieved if set to 4, 6 or even 8. Please note that the higher the number is, the more time is needed to hang up the channel. However, this might lower the probability to get random hang up.
<b>Congestion Detection</b>	Congestion detection is used to detect far end congestion signal. The default setting is “Yes”.
<b>Congestion Count</b>	If “Congestion Detection” is enabled, users can specify the number of congestion tones to wait for. The default setting is 2.
<b>Tone Country</b>	Select the country for tone settings. If “Custom” is selected, users could manually configure the values for Busy Tone and Congestion Tone. The default setting is “United States of America (USA)”.
<b>Busy Tone</b>	<p><u>Syntax:</u>  <code>f1=val[@level][,f2=val[@level]],c=on1/off1[-on2/off2[-on3/off3]];</code>          Frequencies are in Hz and cadence on and off are in ms.          Frequencies Range: [0, 4000]          Busy Level Range: (-300, 0)          Cadence Range: [0, 16383].          Select Tone Country “Custom” to manually configure Busy Tone value.  <u>Default value:</u>  <code>f1=480@-50,f2=620@-50,c=500/500</code></p>
<b>Congestion Tone</b>	<p><u>Syntax:</u>  <code>f1=val[@level][,f2=val[@level]],c=on1/off1[-on2/off2[-on3/off3]];</code>          Frequencies are in Hz and cadence on and off are in ms.          Frequencies Range: [0, 4000]          Busy Level Range: (-300, 0)          Cadence Range: [0, 16383].          Select Tone Country “Custom” to manually configure Busy Tone value.  <u>Default value:</u>  <code>f1=480@-50,f2=620@-50,c=250/250</code></p>
<b>PSTN Detection</b>	Click on “Detect” to detect the busy tone, Polarity Reversal and Current Disconnect by PSTN. Before the detecting, please make sure there is more than one channel configured and working properly. If the detection has busy tone, the “Tone Country” option will be set as “Custom”.



## PSTN Detection

The UCM6510 provides PSTN detection function to help users detect the busy tone, Polarity Reversal and Current Disconnect by making a call from the PSTN line to another destination. The detecting call will be answered and up for about 1 minute. Once done, the detecting result will show and can be used for the UCM6510 settings.

1. Go to UCM6510 Web GUI→**Extension/Trunk**→**Analog Trunks** page.
2. Click to edit the analog trunk created for the FXO port.
3. In the dialog window to edit the analog trunk, go to “Tone Settings” section and click on “Detect” for “PSTN Detection”.

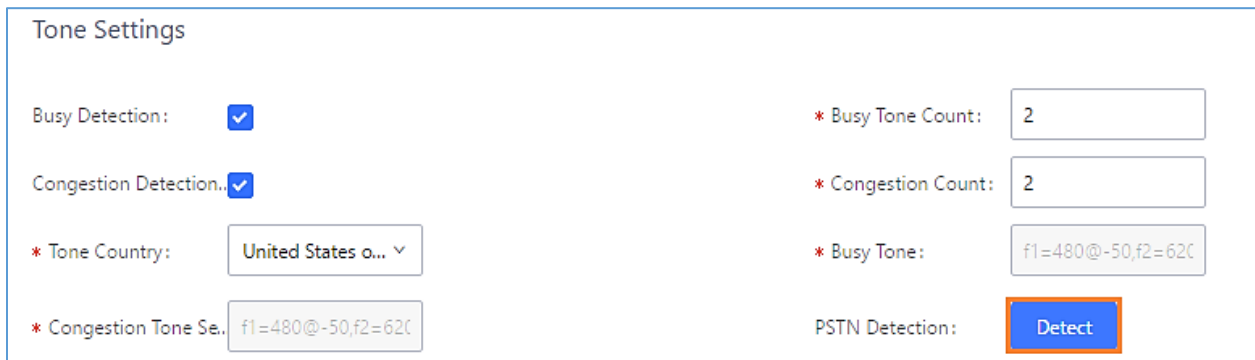


Figure 98: UCM6510 FXO Tone Settings

4. Click on “Detect” to start PSTN detection.

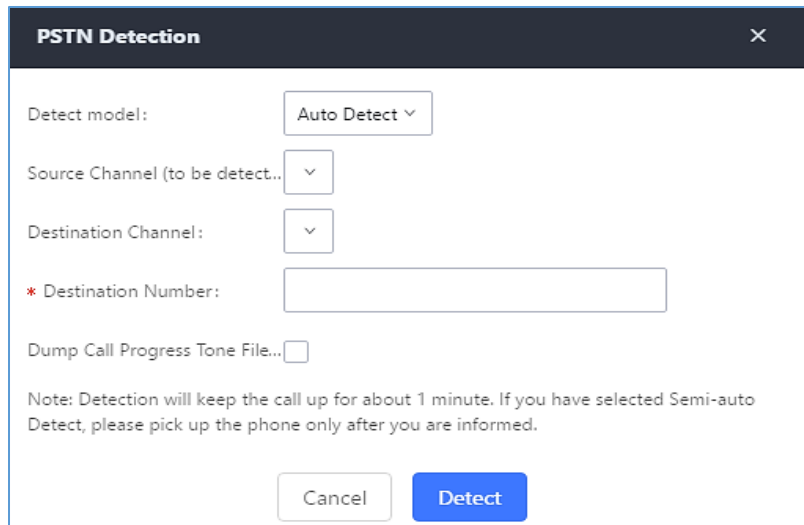


Figure 99: UCM6510 PSTN Detection

- If there are two FXO ports connected to PSTN lines, use the following settings for auto-detection.

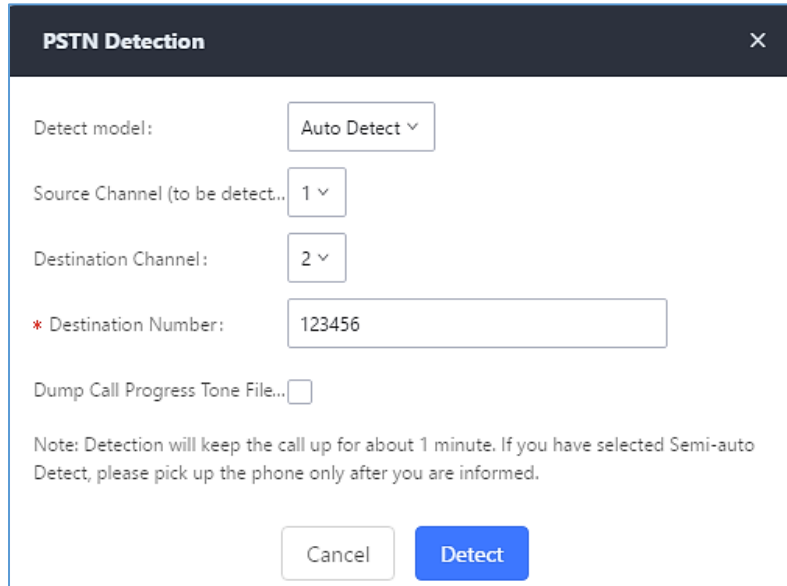
**Detect Model:** Auto Detect.

**Source Channel:** The source channel to be detected.



**Destination Channel:** The channel to help detecting. For example, the second FXO port.

**Destination Number:** The number to be dialed for detecting. This number must be the actual PSTN number for the FXO port used as the destination channel.



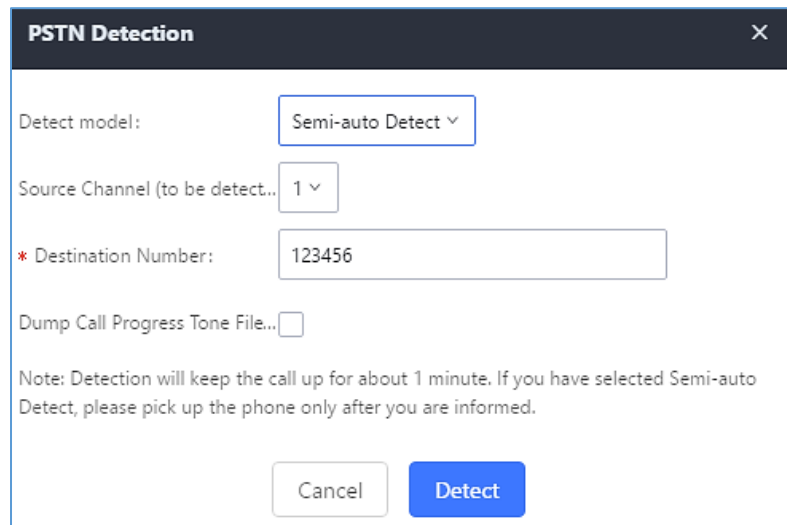
The screenshot shows a dialog box titled "PSTN Detection" with a close button (X) in the top right corner. The settings are as follows:

- Detect model: Auto Detect (dropdown menu)
- Source Channel (to be detect...): 1 (dropdown menu)
- Destination Channel: 2 (dropdown menu)
- \* Destination Number: 123456 (text input field)
- Dump Call Progress Tone File...:

Below the input fields is a note: "Note: Detection will keep the call up for about 1 minute. If you have selected Semi-auto Detect, please pick up the phone only after you are informed." At the bottom are two buttons: "Cancel" and "Detect".

**Figure 100: UCM6510 PSTN Detection: Auto Detect**

- If there is only one FXO port connected to PSTN line, use the following settings for auto-detection.



The screenshot shows a dialog box titled "PSTN Detection" with a close button (X) in the top right corner. The settings are as follows:

- Detect model: Semi-auto Detect (dropdown menu)
- Source Channel (to be detect...): 1 (dropdown menu)
- \* Destination Number: 123456 (text input field)
- Dump Call Progress Tone File...:

Below the input fields is a note: "Note: Detection will keep the call up for about 1 minute. If you have selected Semi-auto Detect, please pick up the phone only after you are informed." At the bottom are two buttons: "Cancel" and "Detect".

**Figure 101: UCM6510 PSTN Detection: Semi-Auto Detect**

**Detect Model:** Semi-auto Detect.

**Source Channel:** The source channel to be detected.



**Destination Number:** The number to be dialed for detecting. This number could be a cell phone number or other PSTN number that can be reached from the source channel PSTN number.

5. Click “Detect” to start detecting. The source channel will initiate a call to the destination number. For “Auto Detect”, the call will be automatically answered. For “Semi-auto Detect”, the UCM6510 Web GUI will display prompt to notify the user to answer or hang up the call to finish the detecting process.
6. Once done, the detected result will show. Users could save the detecting result as the current UCM6510 settings.

**Table 49: PSTN Detection for Analog Trunk**

<b>Detect Model</b>	<p>Select “Auto Detect” or “Semi-auto Detect” for PSTN detection.</p> <ul style="list-style-type: none"> <li>• <b>Auto Detect</b> Please make sure two or more channels are connected to the UCM6510 and in idle status before starting the detection. During the detection, one channel will be used as caller (Source Channel) and another channel will be used as callee (Destination Channel). The UCM6510 will control the call to be established and hang up between caller and callee to finish the detection.</li> <li>• <b>Semi-auto Detect</b> Semi-auto detection requires answering or hanging up the call manually. Please make sure one channel is connected to the UCM6510 and in idle status before starting the detection. During the detection, source channel will be used as caller and send the call to the configured Destination Number. Users will then need follow the prompts in Web GUI to help finish the detection.</li> </ul> <p>The default setting is “Auto Detect”.</p>
<b>Source Channel</b>	Select the channel to be detected.
<b>Destination Channel</b>	Select the channel to help detect when “Auto Detect” is used.
<b>Destination Number</b>	Configure the number to be called to help the detection.


 **Note:**

- The PSTN detection process will keep the call up for about 1 minute.
- If “Semi-auto Detect” is used, please pick up the call only after informed from the Web GUI prompt.
- Once the detection is successful, the detected parameters “Busy Tone”, “Polarity Reversal” and “Current Disconnect by PSTN” will be filled into the corresponding fields in the analog trunk configuration.

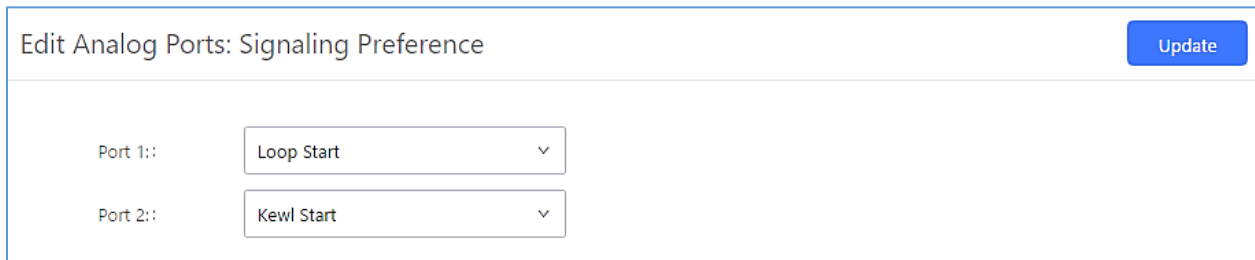


## DAHDI and Analog Hardware Configuration

### Analog Hardware

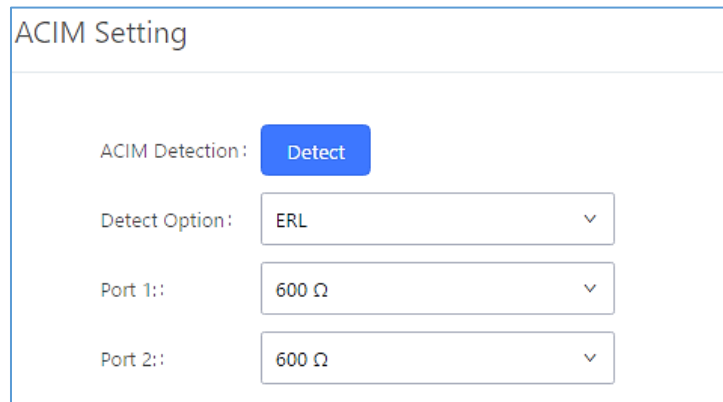
The analog hardware (FXS port and FXO port) on the UCM6510 can be configured under Web GUI→**PBX Settings**→**Interface Settings**. Click on  to edit signaling preference for FXS port or configure ACIM settings for FXO port.

Select “Loop Start” or “Kewl Start” for each FXS port. And then click on “Update” to save the change.



**Figure 102: FXS Ports Signaling Preference**

For FXO port, users could manually enter the ACIM settings by selecting the value from dropdown list for each port. Or users could click on "Detect" and choose the detection algorithm, two algorithms exist (ERL, Pr) for the UCM6510 to automatically detect the ACIM value. The detecting value will be automatically filled into the settings.



**Figure 103: FXO Ports ACIM Settings**

---

 **Note:**

ACIM setting is very important for the FXO/PSTN line to work properly on the UCM6510. If the users experience echo, caller ID or disconnecting issue, please make sure to run the ACIM detection to find out the correct value for impedance setting.

---

**Table 50: Analog Hardware Configuration Parameters**

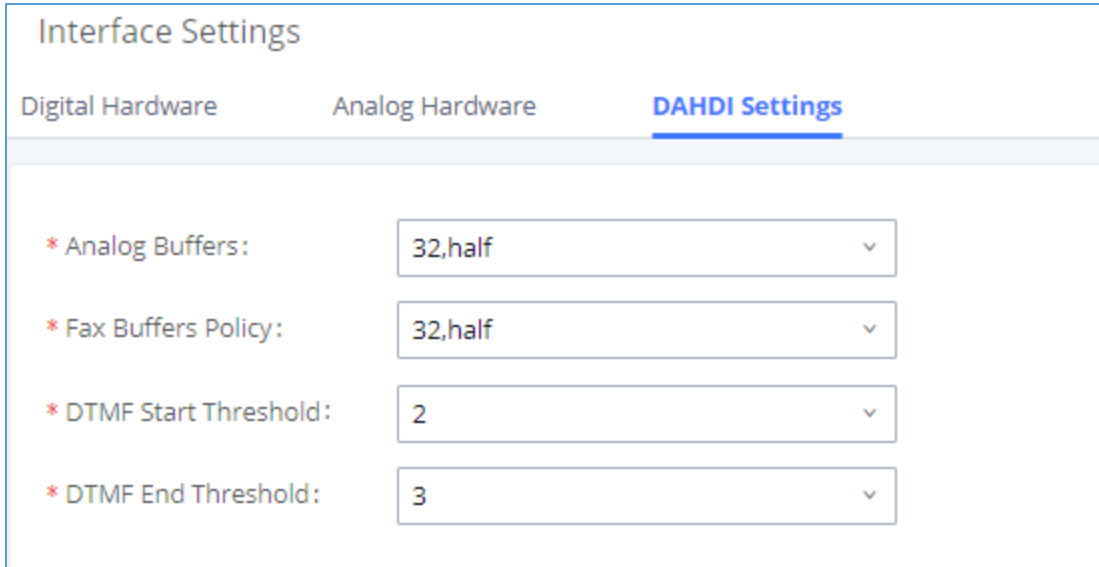
<b>Tone Region</b>	Select country to set the default tones for dial tone, busy tone, ring tone and etc to be sent from the FXS port. The default setting is “United States of America (USA)”.
<b>Advanced Settings</b>	
<b>FXO Opermode</b>	Select country to set the On-Hook Speed, Ringer Impedance, Ringer Threshold, Current Limiting, TIP/RING voltage adjustment, Minimum Operational Loop Current, and AC Impedance as predefined for your country’s analog line characteristics. The default setting is “USA”.
<b>FXS Opermode</b>	Select country to set the On-Hook Speed, Ringer Impedance, Ringer Threshold, Current Limiting, TIP/RING voltage adjustment, Minimum Operational Loop Current, and AC Impedance as predefined for your country’s analog line characteristics. The default setting is “United States of America (USA)”.
<b>FXS TISS Override</b>	Configure to enable or disable override Two-Wire Impedance Synthesis (TISS). The default setting is No. If enabled, users can select the impedance value for Two-Wire Impedance Synthesis (TISS) override. The default setting is 600Ω.
<b>PCMA Override</b>	Select the codec to be used for analog lines. North American users should choose PCMU. All other countries, unless already known, should be assumed to be PCMA. The default setting is PCMU. <b>Note:</b> This option requires system reboot to take effect.
<b>Boost Ringer</b>	Configure whether normal ringing voltage (40V) or maximum ringing voltage (89V) for analog phones attached to the FXS port is required. The default setting is “Normal”.
<b>Fast Ringer</b>	Configure to increase the ringing speed to 25HZ. This option can be used with “Low Power” option. The default setting is “Normal”.
<b>Low Power</b>	Configure the peak voltage up to 50V during “Fast Ringer” operation. This option is used with “Fast Ringer”. The default setting is “Normal”.
<b>Ring Detect</b>	If set to “Full Wave”, false ring detection will be prevented for lines where Caller ID is sent before the first ring and proceeded by a polarity reversal, as in UK. The default setting is “Standard”.
<b>FXS MWI Mode</b>	Configure the type of Message Waiting Indicator on FXS lines. The default setting is “FSK”. <ul style="list-style-type: none"> <li>• <b>FSK:</b> Frequency Shift Key Indicator</li> <li>• <b>NEON:</b> Light Neon Bulb Indicator.</li> </ul>
<b>FXO Frequency Tolerance</b>	Allows users to adjust the tolerance of the FXO ringing frequency. 63Hz is considered the standard value and is selected by default.





## DAHDI Settings

When users encounter issues such as audio delay in outbound calls using the analog trunk, they can adjust DAHDI settings on the UCM to attempt to lessen or resolve the issues.



Interface Settings		
Digital Hardware	Analog Hardware	DAHDI Settings
* Analog Buffers:	32,half	▼
* Fax Buffers Policy:	32,half	▼
* DTMF Start Threshold:	2	▼
* DTMF End Threshold:	3	▼

**Figure 104: Dahdi Settings**

For the value of the option such as “32, half”:

The number in the option indicates the number of read/write buffers for TDM (DAHDI).

The “Half”, “Immediate” or “Full” option indicates the strategy when reading/writing data from buffer.

- **“Half”**: Data will be read/written from buffer when half of the buffer is occupied with data.
- **“Immediate”**: Read/write from buffer whenever there is data occupying the buffer.
- **“Full”**: Data will be read/written from buffer when buffer is fully occupied with data.

**DTMF Start Threshold**: Indicates the minimum number of times a single DTMF must be detected in a signal before it is considered valid.

**DTMF End Threshold**: Indicates the minimum number of times an end signal for a single DTMF number must be detected before it is considered valid.

Normally, DAHDI settings should be kept default and should be adjusted only when users encounter analog trunk/Fax-related issues.

## DIGITAL TRUNKS

The UCM6510 supports E1/T1/J1 which are physical connection technology used in digital network. E1 is the European standard, T1 is the North American standard, and J1 is the Japanese standard.

UCM6510 supports four signaling protocols: PRI, MFC/R2, SS7, E&M Immediate and E&M Wink. PRI provides a varying number of channels depending on the standards in the country of implementation (E1, T1 or J1); MFC/R2 is a signaling protocol heavily used over E1 trunks; SS7 uses out-of-band signaling, which travels on a separate, dedicated channel rather than within the same channel as the telephone call, providing more efficiency and higher security level when the telephone calls are set up. E&M Immediate and E&M Wink are only valid when using T1 port.

To set up digital trunk on the UCM6510:

1. Go to Web GUI→**PBX Settings**→**Interface Settings**→**Digital Hardware** to configure port type and channels.
2. Go to Web GUI→**Extension/Trunk**→**Digital Trunks** to add and edit digit trunk.
3. Go to Web GUI→**Extension/Trunk**→**Outbound Routes** and **Inbound Routes** to configure outbound and inbound rule for the digital trunk.

### Digital Hardware Configuration

Go to Web GUI→ **PBX Settings**→**Interface Settings**→**Digital Hardware** page and configure the following:










Interface Settings			
<u>Digital Hardware</u>		Analog Hardware	
Type	Port	Options	
<input type="checkbox"/> E1	1	 	
Group Name	Channel	Options	
DefaultGroup1	1-8	 	
Test	9-15,17-31	 	

Figure 105: Digital Hardware Configuration



- **Step 1:** Click on  to edit digital ports. Please see configuration parameters in the tables below.
- **Step 2:** Click on  to edit group. This assigns channels to be used for the digital port. For E1, 30 B channels can be assigned to the default group; for T1/J1, 23 B channels can be assigned to the default group.
- **Step 3:** If fewer than 30 B channels for E1 or 23 B channels for T1/J1 are assigned in default group, users can click on  to add more groups. This is not necessary in most cases and only default group is needed.

 **Note:**

Currently, the group configuration in digital trunks settings manages outbound routes only. It does not control inbound routes. Therefore, if the users have configured multiple groups for the digital trunk, please make sure the inbound routes for those groups have the same inbound rule configured. Otherwise, inbound call using the digital trunk might not work properly.

The UCM6510 currently supports E1, T1 and J1 digital hardware type. When different signaling is selected for E1, T1 or J1, the settings in basic options and advanced options will be different. The following tables list all the settings to configure digital ports when selecting each signaling.

**Table 51: Digital Hardware Configuration Parameters: E1 – PRI\_NET/PRI\_CPE**

Basic Settings	
<b>Clock</b>	<p>All E1/T1/J1 spans generate a clock signal on their transmit side. The parameter determines whether the clock signal from the far end of the E1/T1/J1 is used as the master source of clock timing. If the far end is used as the master, the PBX system clock will synchronize to it.</p> <ul style="list-style-type: none"> <li>• <b>Master:</b> The port will never be used as a source of timing. This is appropriate when you know the far end should always be a slave to you.</li> <li>• <b>Slave:</b> The equipment at the far end of the E1/T1/J1 link is the preferred source of the master clock.</li> </ul>
<b>LBO</b>	<p>The line build-out (LBO) is the distance between the operators and the PBX. Please use the default value 0Db unless the distance is long.</p>
<b>RX Gain</b>	<p>Configure the RX gain for the receiving channel of digital port. The valid range is from -24Db to +12Db.</p>
<b>TX Gain</b>	<p>Configure the TX Gain for the transmitting channel of digital port. The valid range is -24Db to +12Db.</p>
<b>Codec</b>	<p>Select alaw or ulaw. If set to default, alaw will be used for E1.</p>



<b>Play Local RBT</b>	Configure whether to play the ringback tone from local UCM6510 or not. If enabled, the local UCM6510 will play ringback tone to the caller. Otherwise, the caller will listen to the tone from peer device. Default setting is disabled.
<b>Advanced Settings</b>	
<b>Switch Type</b>	<p>Select switch type.</p> <ul style="list-style-type: none"> <li>• <b>EuroISDN:</b> EuroISDN (common in Europe)</li> <li>• <b>NI2:</b> National ISDN type 2 (common in the US)</li> <li>• <b>DMS100:</b> Nortel DMS100</li> <li>• <b>4ESS:</b> AT&amp;T 4ESS</li> <li>• <b>5ESS:</b> Lucent 5ESS</li> <li>• <b>NI1:</b> old national ISDN type 1</li> <li>• <b>Q.SIG</b></li> </ul>
<b>Coding</b>	Select "HDB3" or "AMI".
<b>CRC</b>	Select whether to use CRC4 or not.
<b>PRI Dial Plan</b>	<p>This setting is used to specify the type of the callee number. The service provider will usually verify this. The default setting is "unknown". In some very unusual circumstances, you may need set to "Dynamic" or "Redundant".</p> <p><b>Note:</b> When one type is selected, you might not be able to dial another playlist of numbers. For example, if "National" is configured, you will not be able to dial local or international numbers.</p>
<b>PRI Local Dial Plan</b>	This setting is used to specify the type of the caller number. The service provider will usually verify this.
<b>D-Chan</b>	Indicates the D channel for control.
<b>International Prefix</b> <b>National Prefix</b> <b>Local Prefix</b> <b>Private Prefix</b> <b>Unknown Prefix</b>	Configure the prefix in PRI Local Dial Plan and PRI Dial Plan for each type.
<b>PRI T310</b>	Configure PRI T310 Timer (in seconds). The default value is 10 seconds.
<b>PRI Indication</b>	<p>Select the PRI Indication.</p> <ul style="list-style-type: none"> <li>• <b>outofband:</b> Use RELEASE, DISCONNECT or other messages with CAUSE to indicate call progress (e.g., cause: unassigned number or user busy).</li> <li>• <b>inband:</b> use in-band tones to play busy or congestion signal to the other side. This is the default setting.</li> </ul>
<b>Reset Interval</b>	The interval that restarts idle channels.
<b>PRI Exclusive</b>	This setting is used to set up the ChannelID in SETUP message. If enabled,



	only the specified B channel can be used. Otherwise, select one of the channels in B channel. If you need override the existing channels selection routine and force all PRI channels to be marked as exclusively selected, please enable it.
<b>Facility Enable</b>	If selected, transmission of facility-based ISDN supplementary services (such as caller name from CPE over facility) will be enabled.
<b>Overlap Dial</b>	Configure this option to send overlap digits. If enabled, SETUP message can include some digits of callee number, and rest of the digits can be sent using INFORMATION message. If disabled, callee number will be sent via SETUP message when all the digits are ready.
<b>NSF</b>	Some switches (AT&T especially) require network specific facility. Currently the supported values are "none", "sdn", "megacom", "tollfreemegacom".

**Table 52: Digital Hardware Configuration Parameters: E1 - SS7**

Basic Settings	
<b>Clock</b>	<p>All E1/T1/J1 spans generate a clock signal on their transmit side. The parameter determines whether the clock signal from the far end of the E1/T1/J1 is used as the master source of clock timing. If the far end is used as the master, the PBX system clock will synchronize to it.</p> <ul style="list-style-type: none"> <li>• <b>Master:</b> The port will never be used as a source of timing. This is appropriate when you know the far end should always be a slave to you.</li> <li>• <b>Slave:</b> The equipment at the far end of the E1/T1 link is the preferred source of the master clock.</li> </ul>
<b>SS7 Variant</b>	Select ITU, ANSI or CHINA.
<b>Originating Point Code</b>	<p>Originating point code is used to identify the node originating the message, always provided by the operator/ISP.</p> <ul style="list-style-type: none"> <li>• ITU Format: decimal number.</li> <li>• ANSI &amp; CHINA Format: decimal number or XXX-XXX-XXX.</li> </ul>
<b>Destination Point Code</b>	<p>Destination point code is the address to send the message to, always be provided by the operator/ISP.</p> <ul style="list-style-type: none"> <li>• ITU Format: decimal number.</li> <li>• ANSI &amp; CHINA Format: decimal number or XXX-XXX-XXX.</li> </ul>
<b>First CIC</b>	<p>When Span Type is E1, ITU &amp; CHINA Range: [0, 4065], ANSI Range: [0, 16353].</p> <p>When Span Type is T1/J1, ITU &amp; CHINA Range: [0, 4072], ANSI Range: [0, 16360].</p>
<b>Assign CIC To D-channel</b>	If set to yes, D-channel will be assigned a CIC. Else, D-channel will not be assigned. By default, it is set to No.
<b>Network Indicator</b>	Network Indicator (NI) should match in nodes, otherwise it might cause



	issues. Users can select "National", "National Spare", "International", or "International Spare". Usually "National" or "International" is used.
<b>LBO</b>	The line build-out (LBO) is the distance between the operators and the PBX. Please use the default value 0dB unless the distance is long.
<b>RX Gain</b>	Configure the RX gain for the receiving channel of digital port. The valid range is from -24dB to +12dB.
<b>TX Gain</b>	Configure the TX Gain for the transmitting channel of digital port. The valid range is -24dB to +12dB.
<b>Codec</b>	Select alaw or ulaw. If set to default, alaw will be used for E1.
<b>Advanced Settings</b>	
<b>Coding</b>	Select "HDB3" or "AMI".
<b>CRC</b>	Select whether to use CRC4 or not.
<b>Called Nature of Address Indicator</b>	Indicates the type of the called number. The receiving switch may use this indicator during translations to apply the number's proper dial plan. Users can select "Unknown", "Subscriber", "National", "International" or "Dynamic".
<b>Calling Nature of Address Indicator</b>	Indicates the type of the calling number. The receiving switch may use this indicator during translations to apply the number's proper dial plan. Users can select "Unknown", "Subscriber", "National", "International" or "Dynamic".
<b>D-Chan</b>	Indicates the D channel for control
<b>International Prefix</b> <b>National Prefix</b> <b>Subscriber Prefix</b> <b>Unknown Prefix</b>	Configure the prefix in Called Nature of Address Indicator and Calling Nature of Address Indicator for each type.

**Table 53: Digital Hardware Configuration Parameters: E1 - MFC/R2**

<b>Basic Settings</b>	
<b>Clock</b>	<p>All E1/T1/J1 spans generate a clock signal on their transmit side. The parameter determines whether the clock signal from the far end of the E1/T1/J1 is used as the master source of clock timing. If the far end is used as the master, the PBX system clock will synchronize to it.</p> <ul style="list-style-type: none"> <li>• <b>Master:</b> The port will never be used as a source of timing. This is appropriate when you know the far end should always be a slave to you.</li> <li>• <b>Slave:</b> The equipment at the far end of the E1/T1 link is the preferred source of the master clock.</li> </ul>
<b>Variant</b>	MFC/R2 multinational adaption. UCM6510 supports MFC/R2 standards by



	ITU and MFC/R2 standards in different countries or regions including Argentina, Brazil, China, Czech Republic, Colombia, Ecuador, Indonesia, Mexico, the Philippines and Venezuela.
<b>Get ANI First</b>	<p>If enabled, the callee side will request the caller to send caller number first and then called number.</p> <p><b>Note:</b> Options "Get ANI First" and "Skip Category" cannot be enabled at the same time.</p>
<b>Category</b>	Select the category of the caller. UCM6510 supports four categories: National Subscriber, National Priority Subscriber, International Subscriber and International Priority Subscriber.
<b>LBO</b>	The line build-out (LBO) is the distance between the operators and the PBX. Please use the default value 0dB unless the distance is long.
<b>RX Gain</b>	Configure the RX gain for the receiving channel of digital port. The valid range is from -24dB to +12dB.
<b>TX Gain</b>	Configure the TX Gain for the transmitting channel of digital port. The valid range is -24dB to +12dB.
<b>Play Local RBT</b>	This configured whether to play the ringback tone from local UCM6510 or not. If enabled, the local UCM6510 will play ringback tone to the caller. Otherwise, the caller will listen to the tone from peer device. The default setting is disabled.
<b>Advanced Settings</b>	
<b>Coding</b>	Select "HDB3" or "AMI".
<b>CRC</b>	Select whether to use CRC4 or not.
<b>MF Back Timeout (ms)</b>	MFC/R2 value in milliseconds for MF timeout. Values smaller than 500ms are not recommended. -1 represents default value.
<b>Metering Pulse Timeout (ms)</b>	MFC/R2 value in milliseconds for the metering pulse timeout. Metering pulse is sent by some telcos for some R2 variants during a call for billing purposes to indicate costs. Should not last more than 500ms, -1 represents default value, and for Argentina the default value is 400ms, for others is 0ms.
<b>Allow Collect Calls</b>	<p>Brazil has a special calling party category for collect calls (llamadas por cobrar) instead of using the operator (as in Mexico). The R2 spec in Brazil says a special GB tone should be used to reject collect calls.</p> <p>By default, this is disabled, which means collect calls will be blocked.</p>
<b>Double Answer</b>	Some PBXs require a double-answer process to block collect calls. If users have problem blocking collect calls using Group B signals, please try enabling this option.
<b>Accept On Offer</b>	By default, it is enabled. In most of cases, this option should be enabled.



<b>Skip Category</b>	<p>If enabled, the callee side will request the caller to send caller category before sending caller number.</p> <p><b>Note:</b> "Get ANI First" and "Skip Category" cannot be enabled at the same time.</p>
<b>Charge Calls</b>	<p>Whether or not report to the other end "accept call with charge". This setting has no effect with most telecos. The default setting is enabled (recommended).</p>
<b>Custom Options</b>	<p>Click on "Custom Options" button (on the right top of the configuration dialog) and then user can customize desired tone and timer options accordingly.</p>

Table 54: Digital Hardware Configuration Parameters: T1/J1 - PRI\_NET/PRI\_CPE

Basic Settings	
<b>Clock</b>	<p>All E1/T1/J1 spans generate a clock signal on their transmit side. The parameter determines whether the clock signal from the far end of the E1/T1/J1 is used as the master source of clock timing. If the far end is used as the master, the PBX system clock will synchronize to it.</p> <ul style="list-style-type: none"> <li>• <b>Master:</b> The port will never be used as a source of timing. This is appropriate when you know the far end should always be a slave to you.</li> <li>• <b>Slave:</b> The equipment at the far end of the E1/T1/J1 link is the preferred source of the master clock.</li> </ul>
<b>LBO</b>	<p>The line build-out (LBO) is the distance between the operators and the PBX. Please use the default value 0dB unless the distance is long.</p>
<b>RX Gain</b>	<p>Configure the RX gain for the receiving channel of digital port. The valid range is from -24dB to +12dB.</p>
<b>TX Gain</b>	<p>Configure the TX Gain for the transmitting channel of digital port. The valid range is -24dB to +12dB.</p>
<b>Codec</b>	<p>Select alaw or ulaw. If set to default, ulaw will be used for T1/J1.</p>
<b>Play Local RBT</b>	<p>This configured whether to play the ringback tone from local UCM6510 or not. If enabled, the local UCM6510 will play ringback tone to the caller. Otherwise, the caller will listen to the tone from peer device. The default setting is disabled.</p>
<b>Framing</b>	<p>Select "esf" or "d4". Default setting is esf.</p>
Advanced Settings	





<b>Switch Type</b>	<p>Select switch type.</p> <ul style="list-style-type: none"> <li>• <b>EuroISDN:</b> EuroISDN (common in Europe)</li> <li>• <b>NI2:</b> National ISDN type 2 (common in the US)</li> <li>• <b>DMS100:</b> Nortel DMS100</li> <li>• <b>4ESS:</b> AT&amp;T 4ESS</li> <li>• <b>5ESS:</b> Lucent 5ESS</li> <li>• <b>NI1:</b> old national ISDN type 1</li> <li>• <b>Q.SIG</b></li> </ul>
<b>Coding</b>	Select "B8ZS" or "AMI".
<b>PRI Dial Plan</b>	<p>This setting is used to specify the type of the callee number. The service provider will usually verify this. The default setting is "unknown". In some very unusual circumstances, you may need set to "Dynamic" or "Redundant".</p> <p><b>Note:</b></p> <p>When one type is selected, you might not be able to dial another playlist of numbers. For example, if "National" is configured, you will not be able to dial local or international numbers.</p>
<b>PRI Local Dial Plan</b>	This setting is used to specify the type of the caller number. The service provider will usually verify this.
<b>D-Chan</b>	Indicates the D channel for control.
<b>International Prefix</b> <b>National Prefix</b> <b>Local Prefix</b> <b>Private Prefix</b> <b>Unknown Prefix</b>	Configure the prefix in PRI Local Dial Plan and PRI Dial Plan for each type.
<b>PRI T310</b>	Configure PRI T310 Timer (in seconds). The default value is 10 seconds.
<b>PRI Indication</b>	<p>Select the PRI Indication.</p> <ul style="list-style-type: none"> <li>• <b>outofband:</b> Use RELEASE, DISCONNECT or other messages with CAUSE to indicate call progress (e.g., cause: unassigned number or user busy).</li> <li>• <b>inband:</b> use in-band tones to play busy or congestion signal to the other side. This is the default setting.</li> </ul>
<b>Reset Interval</b>	The interval that restarts idle channels.
<b>PRI Exclusive</b>	This setting is used to set up the ChannelID in SETUP message. If enabled, only the specified B channel can be used. Otherwise, select one of the channels in B channel. If you need override the existing channels selection routine and force all PRI channels to be marked as exclusively selected, please enable it.
<b>Facility Enable</b>	If selected, transmission of facility-based ISDN supplementary services



	(such as caller name from CPE over facility) will be enabled.
<b>Overlap Dial</b>	Configure this option to send overlap digits. If enabled, SETUP message can include some digits of callee number, and rest of the digits can be sent using INFORMATION message. If disabled, callee number will be sent via SETUP message when all the digits are ready.
<b>NSF</b>	Some switches (AT&T especially) require network specific facility. Currently the supported values are "none", "sdn", "megacom", "tollfreemegacom", "accunet".

**Table 55: Digital Hardware Configuration Parameters: T1/J1 - SS7**

Basic Settings	
<b>Clock</b>	<p>All E1/T1/J1 spans generate a clock signal on their transmit side. The parameter determines whether the clock signal from the far end of the E1/T1/J1 is used as the master source of clock timing. If the far end is used as the master, the PBX system clock will synchronize to it.</p> <ul style="list-style-type: none"> <li>• <b>Master:</b> The port will never be used as a source of timing. This is appropriate when you know the far end should always be a slave to you.</li> <li>• <b>Slave:</b> The equipment at the far end of the E1/T1 link is the preferred source of the master clock.</li> </ul>
<b>SS7 Variant</b>	Select ITU, ANSI or CHINA.
<b>Originating Point Code</b>	<p>Originating point code is used to identify the node originating the message, always provided by the operator/ISP.</p> <ul style="list-style-type: none"> <li>• ITU Format: decimal number.</li> <li>• ANSI &amp; CHINA Format: decimal number or XXX-XXX-XXX.</li> </ul>
<b>Destination Point Code</b>	<p>Destination point code is the address to send the message to, always be provided by the operator/ISP.</p> <ul style="list-style-type: none"> <li>• ITU Format: decimal number.</li> <li>• ANSI &amp; CHINA Format: decimal number or XXX-XXX-XXX.</li> </ul>
<b>First CIC</b>	<p>When Span Type is E1, ITU &amp; CHINA Range: [0, 4065], ANSI Range: [0, 16353].</p> <p>When Span Type is T1/J1, ITU &amp; CHINA Range: [0,4072], ANSI Range: [0, 16360].</p>
<b>Assign CIC to D-Channel</b>	If set to yes, D-channel will be assigned with a CIC. Else, D-channel will not be assigned with a CIC. By default, it is set to No.
<b>Network Indicator</b>	Network Indicator (NI) should match in nodes, otherwise it might cause issues. Users can select "National", "National Spare", "International", or "International Spare". Usually "National" or "International" is used.
<b>LBO</b>	The line build-out (LBO) is the distance between the operators and the PBX.



	Please use the default value 0dB unless the distance is long.
<b>RX Gain</b>	Configure the RX gain for the receiving channel of digital port. The valid range is from -24dB to +12dB.
<b>TX Gain</b>	Configure the TX Gain for the transmitting channel of digital port. The valid range is -24dB to +12dB.
<b>Codec</b>	Select alaw or ulaw. If set to default, ulaw will be used for T1/J1.
<b>Framing</b>	Select "esf" or "d4". Default setting is esf.
<b>Advanced Settings</b>	
<b>Coding</b>	Select "B8ZS" or "AMI".
<b>Called Nature of Address Indicator</b>	Indicates the type of the called number. The receiving switch may use this indicator during translations to apply the number's proper dial plan. Users can select "Unknown", "Subscriber", "National", "International" or "Dynamic".
<b>Calling Nature of Address Indicator</b>	Indicates the type of the calling number. The receiving switch may use this indicator during translations to apply the number's proper dial plan. Users can select "Unknown", "Subscriber", "National", "International" or "Dynamic".
<b>D-Chan</b>	Indicates the D channel for control.
<b>International Prefix National Prefix Subscriber Prefix Unknown Prefix</b>	Configure the prefix in Called Nature of Address Indicator and Calling Nature of Address Indicator for each type.

**Table 56: Digital Hardware Configuration Parameters: T1-E&M Immediate/E&M Wink**




<b>Basic Setting</b>	
<b>Clock</b>	<p>All E1/T1/J1 spans generate a clock signal on their transmit side. The parameter determines whether the clock signal from the far end of the E1/T1/J1 is used as the master source of clock timing. If the far end is used as the master, the PBX system clock will synchronize to it.</p> <ul style="list-style-type: none"> <li>• <b>Master:</b> The port will never be used as a source of timing. This is appropriate when you know the far end should always be a slave to you.</li> <li>• <b>Slave:</b> The equipment at the far end of the E1/T1/J1 link is the preferred source of the master clock.</li> </ul>
<b>RX Gain</b>	Configure the RX gain for the receiving channel of digital port. The valid range is from -24dB to +12dB.
<b>TX Gain</b>	Configure the TX Gain for the transmitting channel of digital port. The valid



	range is -24dB to +12dB.
<b>Codec</b>	Select alaw or ulaw. The default codec is ulaw for T1.
<b>Framing</b>	Select "esf" or "d4". Default setting is esf.
<b>Advanced Settings</b>	
<b>Coding</b>	Select B8ZS or AMI. The default setting is B8ZS for T1.
<b>OutgoingDialDelay</b>	The option is only valid for E&M Wink signaling. The dial delay interval after received WINK event in an outgoing call. The default value is 200ms.
<b>rxwink</b>	Configure receive wink timing. The default setting is 300ms.

## Digital Trunk Configuration

After configuring digital hardware, go to Web GUI→**Extension/Trunk**→**Digital Trunks**.

- Click on "Create New Digital Trunk" to add a new digital trunk.
- Click on  to configure detailed parameters for the digital trunk.
- Click on  to configure Direct Outward Dialing (DOD) for the digital Trunk.
- Click on  to delete the digital trunk.

The digital trunk parameters are listed in the table below.

**Table 57: Digital Trunk Configuration Parameters**

<b>Trunk Name</b>	Configure trunk name to identify the digital trunk.
<b>Channel Group</b>	Configure the digital channel group used by the trunk.
<b>Hide CallerID</b>	Configure to hide outgoing caller ID. The default setting is "No".
<b>Keep Trunk CID</b>	If enabled, the trunk CID will not be overridden by extension's CID when the extension has CID configured. The default setting is "No".
<b>Caller ID</b>	<p>Configure the Caller ID. This is the number that the trunk will try to use when making outbound calls. For some providers, it might not be possible to set the CallerID with this option and this option will be ignored.</p> <p><b>Important Note:</b> When making outgoing calls, the following priority order rule will be used to determine which CallerID will be set before sending out the call:</p> <p>From user (Register Trunk Only) → CID from inbound call (<b>Keep Original CID</b> Enabled) → Trunk Username/CallerID (<b>Keep Trunk CID</b> Enabled) → DOD → Extension CallerID Number → Trunk Username/CallerID (<b>Keep Trunk CID</b> Disabled) → Global Outbound CID.</p>



<b>CallerID Name</b>	Configure the new name of the caller when the extension has no CallerID Name configured.
<b>Auto Record</b>	Enable automatic recording for the calls using this trunk (for SIP trunk only). The default setting is disabled. The recording files are saved in external storage device if plugged in and can be accessed under Web GUI→ <b>CDR</b> → <b>Recording Files</b> .
<b>DAHDI Out Line Selection</b>	Select DAHDI line type. Default: Ascending
<b>Direct Callback</b>	Allows external numbers the option to get directed to the extension that last called them. <b>Notes:</b> <ul style="list-style-type: none"> <li>Allows external numbers the option to get directed to the extension that last called them.</li> <li>Direct Callback option will be hidden if E&amp;M Immediate or E&amp;M Wink is selected for the Edit T1 Port→Signaling field due to not being applicable.</li> </ul>
<b>Fax Detection</b>	Enable to detect Fax signal from the trunk during the call and send the received Fax to the default Email address in Fax setting page under Web GUI→ <b>Call Features</b> → <b>Fax/T.38</b> . <b>Note:</b> If enabled, Fax Pass-through cannot be used.

## Direct Outward Dialing (DOD) via Digital Trunks

Please refer to section [Direct Outward Dialing (DOD) via VoIP Trunks].

## Digital Trunk Troubleshooting

After configuring the digital trunk on the UCM6510 as described above, and it does not work as expected, users can start and download a signaling capture from the **Maintenance**→**Signaling Troubleshooting** page for analysis.

Depending on the signaling selected for the digital trunk, users can go to following pages to capture trace:

PRI Signaling Trace: Web GUI→**Maintenance**→**Signaling Troubleshooting**→**PRI Signaling Trace**

SS7 Signaling Trace: Web GUI→**Maintenance**→**Signaling Troubleshooting**→**SS7 Signaling Trace**

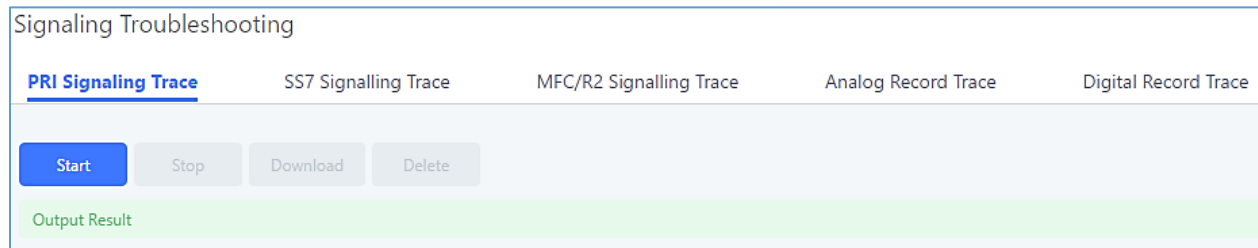
MFC/R2 Signaling Trace: Web GUI→**Maintenance**→**Signaling Troubleshooting**→**MFC/R2 Signaling Trace**

E&M Trace: Web GUI→**Maintenance**→**Signaling Troubleshooting**→**E&M Immediate Record Trace**

Here is the step to capture trace:

1. Click on "Start" to start capturing trace. The output result shows "Capturing..."
2. Once the test is done, click on "Stop" to stop the trace.
3. Click on "Download" to download the trace.





**Figure 106: Troubleshooting Digital Trunks**

For E&M Immediate Signaling, user could configure “Record Direction” and “Record File Mode”.





After capturing a signaling trace, users can download it for analysis. Additionally, they can contact Grandstream Technical Support from the following link for further assistance:  
<http://www.grandstream.com/support>





## DATA TRUNK

The UCM6510 E1/T1/J1 interface also supports data trunk function that allows users to access Internet. Users can select HDLC, HDLC-ETH, Cisco and PPP protocol for the data trunk.

To use data trunk,

1. Go to Web GUI→**PBX Settings**→**Interface Settings**→**Digital Hardware** page and click  to create a new group. Designate a channel for data trunk usage in the group setting.
2. Go to Web GUI→**Extension/Trunk**→**Data Trunks** page, click on  to edit the data trunk.
3. Save the configuration and click on “Apply Changes” for the change to take effect.
4. Once connected, the data trunk will periodically ping and check the status, with status indicator shown for the data trunk on the web page. The status indicator shows  if connected successfully.
5. If the user happens to lose connection or experience unstable connection, click on  to reconnect to help resolve the problem.

Configure digital channels for data communication. If the line happens to have synchronization problems, please try reconnecting.				
Status	Enabled	Port	Encapsulation	Options
●	Turn Off	1	HDLC	 

**Figure 107: Data Trunk Web Page**

### Data Trunk

Data Enable:

\* Channel Group:

Encapsulation:

\* Local IP:

\* Subnet Mask:

\* Remote IP:

\* DNS Server 1:

DNS Server 2:

Default Interface:

**Figure 108: Data Trunk Configuration**



**Table 58: Data Trunk Configuration Parameters**

<b>Data Enable</b>	Select the checkbox to enable/disable data trunk. Users can also click on the ON/OFF switch in data trunk web page to enable/disable this.
<b>Channel Group</b>	Select the digital channel group from the dropdown list to be used for data trunk. Users will need create a new group under Web GUI→ <b>PBX Settings</b> → <b>Interface Settings</b> → <b>Digital Hardware</b> page for this purpose.
<b>Encapsulation</b>	Select the protocol used for the data trunk. The UCM6510 supports HDLC, HDLC-ETH, PPP, Cisco and Frame Relay.
<b>Local IP</b>	Configure the local IP address for the data port. This IP address should not conflict with the WAN or LAN side IP of the UCM6510.
<b>Subnet Mask</b>	Configure the subnet mask for the data port.
<b>Remote IP</b>	Configure the remote IP address for the data port. This IP will be the gateway IP address if “Default Interface” is enabled for the data trunk.
<b>DNS Server 1</b>	Configure DNS server 1.
<b>DNS Server 2</b>	Configure DNS server 2.
<b>Default Interface</b>	If enabled, this data port will be used as the default interface for Internet connection. The “Remote IP” will be the gateway IP address. This has higher priority than the “Default Interface” assignment (LAN 1 or LAN 2) under Web GUI→ <b>Settings</b> if “Dual” is selected as the network method.









## VOIP TRUNKS

### VoIP Trunk Configuration

VoIP trunks can be configured in UCM6510 under Web GUI→**Extension/Trunk**→**VoIP Trunks**. Once created, the VoIP trunks will be listed with Provider Name, Type, Hostname/IP, Username and Options to edit/detect the trunk.

**Note:** UCM6510 supports now 200 VoIP trunks.

- Click on "Create New SIP Trunk" or "Create New IAX Trunk" to add a new VoIP trunk.
- Click on  to configure detailed parameters for the VoIP trunk.
- Click on  to configure Direct Outward Dialing (DOD) for the SIP Trunk.
- Click on  to start LDAP Sync.
- Click on  to delete the VoIP trunk.

For VoIP trunk example, please refer to the following document:

[http://www.grandstream.com/sites/default/files/Resources/ucm6xxx\\_sip\\_trunk\\_guide.pdf](http://www.grandstream.com/sites/default/files/Resources/ucm6xxx_sip_trunk_guide.pdf)

The VoIP trunk options are listed in the table below.

**Table 59: Create New SIP Trunk**

<b>Type</b>	Select the VoIP trunk type. <ul style="list-style-type: none"> <li>• Peer SIP Trunk</li> <li>• Register SIP Trunk</li> </ul>
<b>Provider Name</b>	Configure a unique label (up to 64 characters) to identify this trunk when listed in outbound rules, inbound rules and etc.
<b>Host Name</b>	Configure the IP address or URL for the VoIP provider's server of the trunk.
<b>Keep Original CID</b>	Keep the CID from the inbound call when dialing out. This setting will override "Keep Trunk CID" option. Please ensure that the remote peer PBX supports matching user entry via the "username" field from authentication line.
<b>Keep Trunk CID</b>	If enabled, the trunk CID will not be overridden by extension's CID when the extension has CID configured. The default setting is "No".
<b>NAT</b>	Turn on this setting when the PBX is using public IP and communicating with devices behind NAT. If there is one-way audio issue, usually it is related to NAT configuration or SIP/RTP port support on the firewall.
<b>Disable This Trunk</b>	If checked, the trunk will be disabled.



	<p><b>Note:</b> If a current SIP trunk is disabled, UCM6510 will send UNREGISTER message (REGISTER message with expires=0) to the SIP provider.</p>
<b>TEL URI</b>	<p>If the trunk has an assigned PSTN telephone number, this field should be set to "User=Phone". Then a "User=Phone" parameter will be attached to the Request-Line and TO header in the SIP request to indicate the E.164 number. If set to "Enable", "Tel:" will be used instead of "SIP:" in the SIP request. The default setting is disabled.</p>
<b>Caller ID</b>	<p>Configure the Caller ID. This is the number that the trunk will try to use when making outbound calls. For some providers, it might not be possible to set the CallerID with this option and this option will be ignored.</p> <p><b>Important Note:</b> When making outgoing calls, the following priority order rule will be used to determine which CallerID will be set before sending out the call :</p> <ul style="list-style-type: none"> <li>• From user (Register Trunk Only) → CID from inbound call (<b>Keep Original CID Enabled</b>) → Trunk Username/CallerID (<b>Keep Trunk CID Enabled</b>) → DOD → Extension CallerID Number → Trunk Username/CallerID (<b>Keep Trunk CID Disabled</b>) → Global Outbound CID.</li> </ul>
<b>Need Registration</b>	<p>Select whether the trunk needs to register on the external server or not when "Register SIP Trunk" type is selected. The default setting is No.</p>
<b>Username</b>	<p>Enter the username to register to the trunk from the provider when "Register SIP Trunk" type is selected.</p>
<b>Password</b>	<p>Enter the password to register to the trunk from the provider when "Register SIP Trunk" is selected.</p>
<b>Auth ID</b>	<p>Enter the Authentication ID for "Register SIP Trunk" type.</p>
<b>Auto Record</b>	<p>Enable automatic recording for the calls using this trunk (for SIP trunk only). The default setting is disabled. The recording files can be accessed under Web GUI→<b>CDR</b>→<b>Recording Files</b>.</p>
<b>Direct Callback</b>	<p>Allows external numbers the option to get directed to the extension that last called them. For Example: User 2002 has dialed external number 061234575 but they were not reachable, once they have received missed call notification on their phone, they would mostly call back the number, if the option "Direct Callback" is enabled then they will be directly bridged to user 2002 regardless of the configured inbound destination.</p>

**Table 60: SIP Register Trunk Configuration Parameters**

Basic Settings	
<b>Provider Name</b>	Configure a unique label to identify this trunk when listed in outbound rules, inbound rules and etc.



<b>Host Name</b>	Configure the IP address or URL for the VoIP provider's server of the trunk.
<b>Transport</b>	Configure the SIP transport protocol to be used in this trunk. The default setting is "UDP". <ul style="list-style-type: none"> <li>• UDP</li> <li>• TCP</li> <li>• TLS</li> </ul>
<b>SIP URI Scheme When Using TLS</b>	When TLS is selected as Transport for register trunk, users can select between SIP and SIPS URI scheme
<b>Keep Original CID</b>	Keep the CID from the inbound call when dialing out. This setting will override "Keep Trunk CID" option. Please make sure that the peer PBX at the other side supports to match user entry using "username" field from authentication line.
<b>Keep Trunk CID</b>	If enabled, the trunk CID will not be overridden by extension's CID when the extension has CID configured. The default setting is "No".
<b>NAT</b>	Turn on this option when the PBX is using public IP and communicating with devices behind NAT. If there is one-way audio issue, usually it is related to NAT configuration or SIP/RTP port configuration on the firewall.
<b>Disable This Trunk</b>	If selected, the trunk will be disabled. <b>Note:</b> If a current SIP trunk is disabled, UCM6510 will send UNREGISTER message (REGISTER message with expires=0) to the SIP provider.
<b>TEL URI</b>	If the trunk has an assigned PSTN telephone number, this field should be set to "User=Phone". Then a "User=Phone" parameter will be attached to the Request-Line and TO header in the SIP request to indicate the E.164 number. If set to "Enable", "Tel:" will be used instead of "SIP:" in the SIP request. The default setting is disabled.
<b>Need Registration</b>	Select whether the trunk needs to register on the external server or not when "Register SIP Trunk" type is selected. The default setting is No.
<b>Allow outgoing calls if registration failure</b>	If enabled, outbound calls can still be made even if registration to the trunk fails. Note: If Need Registration is disabled, this option will be ignored.
<b>CallerID Name</b>	Configure the new name of the caller when the extension has no CallerID Name configured.
<b>From Domain</b>	Configure the domain name of the SIP user account. This will overwrite the domain in the "From" header. Example: If the user account is "1234567", setting "trunk.UCM6510.provider.com" as the From Domain value will result in the following From header: "sip:1234567@trunk.UCM6510.provider.com".



<b>From User</b>	Configure the username of the account. This will overwrite the user value in the From header. This is useful for scenarios where a single user account has multiple DIDs. Example: If the domain is "trunk.UCM6510.provider.com", setting "1234567" as the From User value will result in the following From header: "sip.
<b>Username</b>	Enter the username to register to the trunk from the provider when "Register SIP Trunk" type is selected.
<b>Password</b>	Enter the password to register to the trunk from the provider when "Register SIP Trunk" is selected.
<b>Auth ID</b>	Enter the Authentication ID for "Register SIP Trunk" type.
<b>Auth Trunk</b>	If enabled, the UCM will send 401 response to the incoming call to authenticate the trunk.
<b>Auto Record</b>	Enable automatic recording for the calls using this trunk (for SIP trunk only). The default setting is disabled. The recording files can be accessed under Web GUI→ <b>CDR</b> → <b>Recording Files</b> .
<b>Direct Callback</b>	Allows external numbers the option to get directed to the extension that last called them. For Example: User 2002 has dialed external number 061234575 but they were not reachable, once they have received missed call notification on their phone, they would mostly call back the number, if the option "Direct Callback" is enabled then they will be directly bridged to user 2002 regardless of the configured inbound destination.
<b>Advanced Settings</b>	
<b>Codec Preference</b>	Select audio and video codec for the VoIP trunk. The available codecs are: PCMU, PCMA, GSM, AAL2-G.726-32, G.726, G.722, G.729, G.723, OPUS, ILBC, ADPCM, H.264, H.265, H.263, H.263p RTX, OPUS and VP8.
<b>Send PPI Header</b>	If enabled, the SIP INVITE message sent to the trunk will contain PPI (P-Preferred-Identity) header. The default setting is "No".  <b>Note:</b> "Send PPI Header" and "Send PAI Header" cannot be enabled at the same time. Only one of the two headers are allowed to be contained in the SIP INVITE message.
<b>PPI Mode</b>	<ul style="list-style-type: none"> <li>• <b>Default</b> – Include the trunk's preferred CID (configured in <i>Basic Settings</i>) in the PPI Header.</li> <li>• <b>Original CID</b> – Include the original CID in the PPI Header.</li> </ul>



	<ul style="list-style-type: none"> <li>• <b>DOD Number</b> – Include the trunk’s DOD number in the PPI Header. If no DOD number has been set, the trunk’s preferred CID will be used.</li> </ul>
<b>Send PAI Header</b>	<p>If enabled, the SIP INVITE message sent to the trunk will contain PAI (P-Asserted-Identity) header including configured PAI Header. The default setting is “No”.</p> <p><b>Note:</b> “Send PPI Header” and “Send PAI Header” cannot be enabled at the same time. Only one of the two headers are allowed to be contained in the SIP INVITE message.</p>
<b>PAI Header</b>	<p>If “Send PAI Header” is enabled and “PAI Header” is configured as “123456” for instance, the PAI header in the SIP message sent from the UCM will contain “123456”. If “Send PAI Header” is enabled and “PAI Header” is configured as “empty”, the PAI header in the SIP message sent from the UCM will contain the original CID.</p> <p><b>Note:</b> “Send PAI Header” needs to be enabled in order to use this feature. Only alphanumeric characters are allowed and/or special characters #*-_+. with a limit of 64 characters.</p>
<b>DOD As From Name</b>	<p>If enabled and "From User" is configured, the INVITE's From header will contain the DOD number.</p>
<b>Passthrough PAI Header</b>	<p>If checked and option "Send PAI Header" not checked, the PAI header will be passthrough from one side to the other side.</p>
<b>Outbound Proxy Support</b>	<p>Select to enable outbound proxy in this trunk. The default setting is "No".</p>
<b>Outbound Proxy</b>	<p>When outbound proxy support is enabled, enter the IP address or URL of the outbound proxy.</p>
<b>DID Mode</b>	<p>Configure where to get the destination ID of an incoming SIP call, from SIP Request-line or To-header.</p> <p>The default is set to "Request-line".</p>
<b>DTMF Mode</b>	<p>Configure the default DTMF mode when sending DTMF on this trunk.</p> <ul style="list-style-type: none"> <li>• <b>Default:</b> The global setting of DTMF mode will be used. The global setting for DTMF Mode setting is under Web GUI→<b>PBX Settings</b>→<b>SIP Settings</b>→<b>ToS</b>.</li> <li>• <b>RFC4733:</b> Send DTMF using RFC4733.</li> <li>• <b>Info:</b> Send DTMF using SIP INFO message.</li> <li>• <b>Inband:</b> Send DTMF using inband audio. This requires 64-bit codec, i.e., PCMU and PCMA.</li> <li>• <b>Auto:</b> Send DTMF using RFC4733 if offered. Otherwise, inband will be used.</li> </ul>



<b>Enable Heartbeat Detection</b>	If enabled, the UCM6510 will regularly send SIP OPTIONS to the trunk to check connection status. The default setting is "No".
<b>Heartbeat Frequency</b>	When "Enable Heartbeat Detection" option is set to "Yes", configure the interval (in seconds) of the SIP OPTIONS message sent to the device to check if the device is still online. The default setting is 60 seconds.
<b>Maximum Number of Call Lines</b>	The maximum number of concurrent calls using the trunk. The default settings 0, which means no limit.
<b>Fax Mode</b>	Select Fax mode. The default setting is "None". <ul style="list-style-type: none"> <li>• <b>None:</b> Disable Fax.</li> <li>• <b>Fax Detect:</b> Fax signal from the user/trunk during the call can be detected and the received Fax will be sent to the Email address configured for this extension. If no Email address can be found for the user, the Fax will be sent to the default Email address configured in Fax setting page under Web GUI→<b>Call Features</b>→<b>Fax/T.38</b>.</li> </ul>
<b>SRTP</b>	Enable SRTP for the VoIP trunk. The default setting is "No".
<b>CC Settings</b>	
<b>Enable CC</b>	If enabled, the system will automatically alert the user when a called party is available, given that a previous call to that party failed for some reason.
<b>CC Max Agents</b>	Configure the maximum number of CCSS agents which may be allocated for this channel. In other words, this number serves as the maximum number of CC requests this channel is allowed to make. Minimum is 1.
<b>CC Max Monitors</b>	Configure the maximum number of monitor structures which may be created for this device. This number tells how many callers may request CC services for a specific device at one time. The minimum value is 1.

**Table 61: SIP Peer Trunk Configuration Parameters**

<b>Basic Settings</b>	
<b>Provider Name</b>	Configure a unique label to identify this trunk when listed in outbound rules, inbound rules and etc.
<b>Host Name</b>	Configure the IP address or URL for the VoIP provider's server of the trunk.
<b>Auto Record</b>	Enable automatic recording for the calls using this trunk (for SIP trunk only). The default setting is disabled. The recording files can be accessed under Web GUI→ <b>CDR</b> → <b>Recording Files</b> .
<b>Keep Original CID</b>	Keep the CID from the inbound call when dialing out, this setting will override "Keep Trunk CID" option. Please ensure that the remote peer PBX supports matching user entry via the "username" field from authentication line.



<b>Keep Trunk CID</b>	If enabled, the trunk CID will not be overridden by extension's CID when the extension has CID configured. The default setting is "No".
<b>NAT</b>	Turn on this option when the PBX is using public IP and communicating with devices behind NAT. If there is one-way audio issue, usually it is related to NAT configuration or SIP/RTP port configuration on the firewall.
<b>Disable This Trunk</b>	If selected, the trunk will be disabled. <b>Note:</b> If a current SIP trunk is disabled, UCM6510 will send UNREGISTER message (REGISTER message with expires=0) to the SIP provider.
<b>TEL URI</b>	If the trunk has an assigned PSTN telephone number, this field should be set to "User=Phone". Then a "User=Phone" parameter will be attached to the Request-Line and TO header in the SIP request to indicate the E.164 number. If set to "Enable", "Tel:" will be used instead of "SIP:" in the SIP request. The default setting is disabled.
<b>Caller ID</b>	Configure the Caller ID. This is the number that the trunk will try to use when making outbound calls. For some providers, it might not be possible to set the CallerID with this option and this option will be ignored.  <b>Important Note:</b> When making outgoing calls, the following priority order rule will be used to determine which CallerID will be set before sending out the call: CID from inbound call ( <b>Keep Original CID</b> Enabled) → Trunk Username/CallerID ( <b>Keep Trunk CID</b> Enabled) → DOD → Extension CallerID Number → Trunk Username/CallerID ( <b>Keep Trunk CID</b> Disabled) → Global Outbound CID.
<b>CallerID Name</b>	Configure the name of the caller to be displayed when the extension has no CallerID Name configured.
<b>From Domain</b>	Configure the domain name of the SIP user account. This will overwrite the domain in the "From" header. Example: If the user account is "1234567", setting "trunk.UCM6510.provider.com" as the From Domain value will result in the following From header: "sip:1234567@trunk.UCM6510.provider.com"..
<b>Transport</b>	Configure the SIP transport protocol to be used in this trunk. <ul style="list-style-type: none"> <li>• UDP</li> <li>• TCP</li> <li>• TLS</li> </ul> The default setting is "UDP".
<b>Direct Callback</b>	Allows external numbers the option to get directed to the extension that last called them. For Example: User 2002 has dialed external number 061234575 but they were not reachable, once they have received missed call notification on





	<p>their phone, they would mostly call back the number, if the option “Direct Callback” is enabled then they will be directly bridged to user 2002 regardless of the configured inbound destination.</p>
<b>Advanced Settings</b>	
<b>Codec Preference</b>	<p>Select audio and video codec for the VoIP trunk. The available codecs are: PCMU, PCMA, GSM, AAL2-G.726-32, G.726, G.722, G.729, G.723, OPUS, ILBC, ADPCM, H.264, H.265, H.263, H.263p, RTX, OPUS and VP8.</p>
<b>DID Mode</b>	<p>Configure where to get the destination ID of an incoming SIP call, from SIP Request-line or To-header. The default is set to "Request-line".</p>
<b>DTMF Mode</b>	<p>Configure the default DTMF mode when sending DTMF on this trunk.</p> <ul style="list-style-type: none"> <li>• <b>Default:</b> The global setting of DTMF mode will be used. The global setting for DTMF Mode setting is under Web GUI→<b>PBX Settings</b>→<b>SIP Settings</b>→<b>ToS</b>.</li> <li>• <b>RFC4733:</b> Send DTMF using RFC4733.</li> <li>• <b>Info:</b> Send DTMF using SIP INFO message.</li> <li>• <b>Inband:</b> Send DTMF using inband audio. This requires 64-bit codec, i.e., PCMU and PCMA.</li> <li>• <b>Auto:</b> Send DTMF using RFC4733 if offered. Otherwise, inband.</li> </ul>
<b>Enable Heartbeat Detection</b>	<p>If enabled, the UCM6510 will regularly send SIP OPTIONS to the trunk to check connection status. The default setting is "No".</p>
<b>Heartbeat Frequency</b>	<p>When "Enable Heartbeat Detection" option is set to "Yes", configure the interval (in seconds) of the SIP OPTIONS message sent to the device to check if the device is still online. The default setting is 60 seconds.</p>
<b>Maximum Number of Call Lines</b>	<p>The maximum number of concurrent calls using the trunk. The default settings 0, which means no limit.</p>
<b>Fax Mode</b>	<p>Select Fax mode. The default setting is “None”.</p> <ul style="list-style-type: none"> <li>• <b>None:</b> Disable Fax.</li> <li>• <b>Fax Detect:</b> Fax signal from the user/trunk during the call can be detected and the received Fax will be sent to the Email address configured for this extension. If no Email address can be found for the user, the Fax will be sent to the default Email address configured in Fax setting page under Web GUI→<b>Call Features</b>→<b>Fax/T.38</b>.</li> </ul>
<b>SRTP</b>	<p>Enable SRTP for the VoIP trunk. The default setting is "No".</p>





<b>IPVT Mode</b>	If enabled, it will allow SDP passthrough to Grandstream IPVideoTalk therefore it will allow calls between the UCM and IPVideoTalk. The default setting is disabled.
<b>Sync LDAP Enable</b>	If enabled, the local UCM6510 will automatically provide and update the local LDAP contacts to the remote UCM6510 SIP peer trunk. In order to ensure successful synchronization, the remote UCM6510 peer also needs to enable this option on the SIP peer trunk. The default setting is "No".
<b>Sync LDAP Password</b>	This is the password used for LDAP contact file encryption and decryption during the LDAP sync process. The password must be the same on both UCM6510 peers to ensure successful synchronization.
<b>Sync LDAP Port</b>	Configure TCP port used LDAP sync feature between two peer UCM6510.
<b>LDAP Outbound Rule</b>	Specify an outbound rule for LDAP sync feature. UCM6510 will automatically modify the remote contacts by adding prefix parsed from this rule.
<b>LDAP Dialed Prefix</b>	Specify the prefix for LDAP sync feature. The UCM6510 will automatically modify the remote contacts by adding this prefix.
<b>CC Settings</b>	
<b>Enable CC</b>	If enabled, the system will automatically alert the user when a called party is available, given that a previous call to that party failed for some reason.
<b>CC Max Agents</b>	Configure the maximum number of CCSS agents which may be allocated for this channel. In other words, this number serves as the maximum number of CC requests this channel is allowed to make. The minimum value is 1.
<b>CC Max Monitors</b>	Configure the maximum number of monitor structures which may be created for this device. In other words, this number tells how many callers may request CC services for a specific device at one time. Min. value is 1.

**Table 62: Create New IAX Trunk**

<b>Type</b>	Select the VoIP trunk type. <ul style="list-style-type: none"> <li>• Peer IAX Trunk</li> <li>• Register IAX Trunk</li> </ul>
<b>Provider Name</b>	Configure a unique label to identify this trunk when listed in outbound rules, inbound rules and etc.
<b>Host Name</b>	Configure the IP address or URL for the VoIP provider's server of the trunk.
<b>Keep Trunk CID</b>	If enabled, the trunk CID will not be overridden by extension's CID when the extension has CID configured. The default setting is "No".
<b>Username</b>	Enter the username to register to the trunk from the provider when



	"Register IAX Trunk" type is selected.
<b>Password</b>	Enter the password to register to the trunk from the provider when "Register IAX Trunk" type is selected.
<b>Disable This Trunk</b>	If selected, the trunk will be disabled.

**Table 63: IAX Register Trunk Configuration Parameters**

Basic Settings	
<b>Provider Name</b>	Configure a unique label to identify this trunk when listed in outbound rules, inbound rules and etc.
<b>Host Name</b>	Configure the IP address or URL for the VoIP provider's server of the trunk.
<b>Keep Trunk CID</b>	If enabled, the trunk CID will not be overridden by extension's CID when the extension has CID configured. The default setting is "No".
<b>Disable This Trunk</b>	If selected, the trunk will be disabled.
<b>Caller ID</b>	<p>Configure the Caller ID. This is the number that the trunk will try to use when making outbound calls. For some providers, it might not be possible to set the CallerID with this option and this option will be ignored.</p> <p><b>Important Note:</b> When making outgoing calls, the following priority order rule will be used to determine which CallerID will be set before sending out the call :</p> <p>From user (Register Trunk Only) → CID from inbound call (<b>Keep Original CID</b> Enabled) → Trunk Username/CallerID (<b>Keep Trunk CID</b> Enabled) → DOD → Extension CallerID Number → Trunk Username/CallerID (<b>Keep Trunk CID</b> Disabled) → Global Outbound CID.</p>
<b>CallerID Name</b>	Configure the name of the caller to be displayed when the extension has no CallerID Name configured.
<b>Username</b>	Enter the username to register to the trunk from the provider.
<b>Password</b>	Enter the password to register to the trunk from the provider.
Advanced Settings	
<b>Codec Preference</b>	Select audio and video codec for the VoIP trunk. The available codecs are: PCMU, PCMA, GSM, AAL2-G.726-32, G.726, G.722, G.729, G.723, ILBC, ADPCM, H.264, H.265, H.263, H.263p.
<b>Enable Heartbeat Detection</b>	If enabled, the UCM6510 will regularly send SIP OPTIONS to the device to check if the device is still online. The default setting is "No".
<b>Heartbeat Frequency</b>	When "Enable Heartbeat Detection" option is set to "Yes", configure the interval (in seconds) of the SIP OPTIONS message sent to the device to



	check if the device is still online. The default setting is 60 seconds.
<b>Maximum Number of Call Lines</b>	The maximum number of concurrent calls using the trunk. The default settings 0, which means not limited.
<b>Fax Mode</b>	<p>Select Fax mode. The default setting is “None”.</p> <ul style="list-style-type: none"> <li>• <b>None:</b> Disable Fax.</li> <li>• <b>Fax Detect:</b> Fax signal from the user/trunk during the call can be detected and the received Fax will be sent to the Email address configured for this extension. If no Email address can be found for the user, the Fax will be sent to the default Email address configured in Fax setting page under Web GUI→Call Features→Fax/T.38.</li> </ul>

**Table 64: IAX Peer Trunk Configuration Parameters**

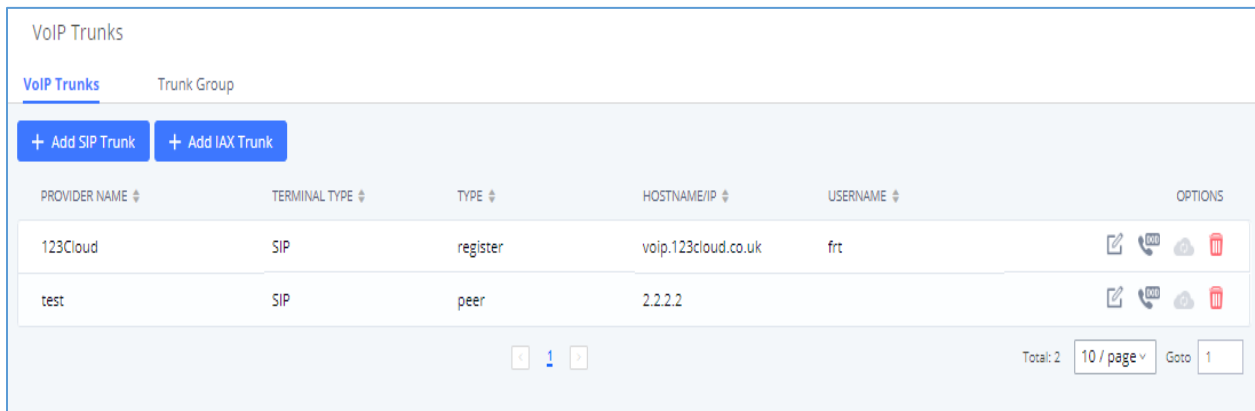
Basic Settings	
<b>Provider Name</b>	Configure a unique label to identify this trunk when listed in outbound rules, inbound rules and etc.
<b>Host Name</b>	Configure the IP address or URL for the VoIP provider’s server of the trunk.
<b>Keep Trunk CID</b>	If enabled, the trunk CID will not be overridden by extension's CID when the extension has CID configured. The default setting is "No".
<b>Disable This Trunk</b>	If selected, the trunk will be disabled.
<b>Caller ID</b>	<p>Configure the Caller ID. This is the number that the trunk will try to use when making outbound calls. For some providers, it might not be possible to set the CallerID with this option and this option will be ignored.</p> <p><b>Important Note:</b> When making outgoing calls, the following priority order rule will be used to determine which CallerID will be set before sending out the call :</p> <p>CID from inbound call (<b>Keep Original CID</b> Enabled) → Trunk Username/CallerID (<b>Keep Trunk CID</b> Enabled) → DOD → Extension CallerID Number → Trunk Username/CallerID (<b>Keep Trunk CID</b> Disabled) → Global Outbound CID.</p>
<b>CallerID Name</b>	Configure the name of the caller to be displayed when the extension has no CallerID Name configured.
Advanced Settings	
<b>Codec Preference</b>	Select audio and video codec for the VoIP trunk. The available codecs are: PCMU, PCMA, GSM, AAL2-G.726-32, G.726, G.722, G.729, G.723, ILBC, ADPCM, H.264, H.265, H.263, H.263p.
<b>Enable Heartbeat Detection</b>	If enabled, the UCM6510 will regularly send SIP OPTIONS to the device



	to check if the device is still online. The default setting is "No".
<b>Heartbeat Frequency</b>	When "Enable Heartbeat Detection" option is set to "Yes", configure the interval (in seconds) of the SIP OPTIONS message sent to the device to check if the device is still online. The default setting is 60 seconds.
<b>Maximum Number of Call Lines</b>	The maximum number of concurrent calls using the trunk. The default settings 0, which means no limited.
<b>Fax Mode</b>	<p>Select Fax mode. The default setting is "None".</p> <ul style="list-style-type: none"> <li>• <b>None:</b> Disable Fax.</li> <li>• <b>Fax Detect:</b> Fax signal from the user/trunk during the call can be detected and the received Fax will be sent to the Email address configured for this extension. If no Email address can be found for the user, the Fax will be sent to the default Email address configured in Fax setting page under Web GUI→Call Features→Fax/T.38.</li> </ul>

## Trunk Groups


Users can create VoIP Trunk Groups to register and easily apply the same settings on multiple accounts within the same SIP server. This can drastically reduce the amount of time needed to manage accounts for the same server and improve the overall cleanliness of the web UI.



The screenshot shows the 'VoIP Trunks' management page. It includes two buttons: '+ Add SIP Trunk' and '+ Add IAX Trunk'. Below these is a table with columns: PROVIDER NAME, TERMINAL TYPE, TYPE, HOSTNAME/IP, USERNAME, and OPTIONS. Two trunks are listed: '123Cloud' (SIP, register, voip.123cloud.co.uk, frt) and 'test' (SIP, peer, 2.2.2.2). At the bottom right, it shows 'Total: 2', '10 / page', and 'Goto 1'.

PROVIDER NAME	TERMINAL TYPE	TYPE	HOSTNAME/IP	USERNAME	OPTIONS
123Cloud	SIP	register	voip.123cloud.co.uk	frt	[Edit] [Phone] [Cloud] [Trash]
test	SIP	peer	2.2.2.2		[Edit] [Phone] [Cloud] [Trash]

**Figure 109: Trunk Group**

Once creating the new trunk group and configuring the SIP settings, users can add multiple accounts within the configured SIP server by pressing  button and configuring the username, password and authentication ID fields.

### Create New SIP Trunk

Type:	<input type="text" value="Register SIP Trunk"/>
* Provider Name:	<input type="text" value="Please select a provider"/>
* Host Name:	<input type="text"/>
Keep Original CID:	<input type="checkbox"/>
Keep Trunk CID:	<input checked="" type="checkbox"/>
NAT:	<input type="checkbox"/>
Disable This Trunk:	<input type="checkbox"/>
TEL URI:	<input type="text" value="Disabled"/>
Need Registration:	<input checked="" type="checkbox"/>
Allow outgoing calls if registration fails:	<input checked="" type="checkbox"/>
CallerID Name:	<input type="text"/>
* Username:	<input type="text"/>
* Password:	<input type="text"/>
AuthID:	<input type="text"/>
AuthTrunk:	<input type="checkbox"/>
Auto Record:	<input type="checkbox"/>
Direct Callback:	<input type="checkbox"/>

Figure 110: Trunk Group Configuration

## Direct Outward Dialing (DOD) via VoIP Trunks

The UCM6510 provides Direct Outward Dialing (DOD) which is a service of a local phone company (or local exchange carrier) that allows subscribers within a company's PBX system to connect to outside lines directly.


### Example of how DOD is used:

Company ABC has a SIP trunk. This SIP trunk has 4 DIDs associated to it. The main number of the office is routed to an auto attendant. The other three numbers are direct lines to specific users of the company. At the moment when a user makes an outbound call their caller ID shows up as the head office number.



This poses a problem as the CEO would like their calls to come from their direct line. This can be accomplished by configuring DOD for the CEO's extension.


### Steps to configure DOD on the UCM:

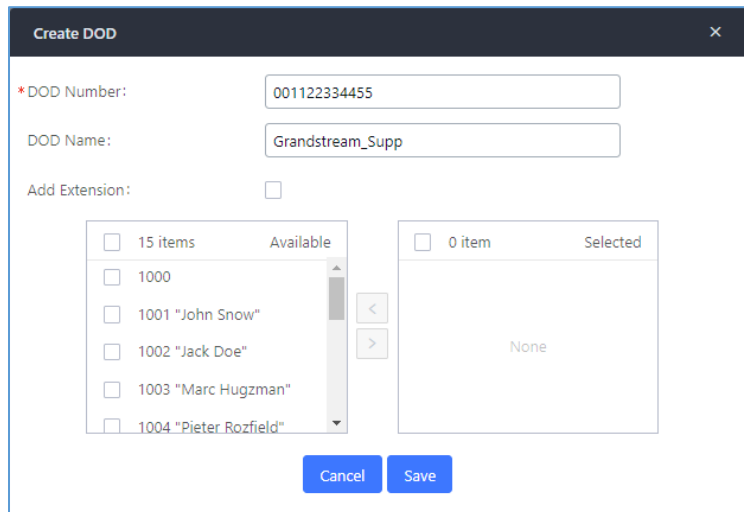
1. To setup DOD go to UCM6510 Web GUI → **Extension/Trunk** → **VoIP Trunks** page.
2. Click  to access the DOD options for the selected SIP Trunk.
3. Click "Create a new DOD" to begin your DOD setup.
4. For "DOD Number" enter one of the numbers (DIDs) from your SIP trunk provider. In the example above Company ABC received 4 DIDs from their provider. ABC will enter the number for the CEO's direct line.

**Note:** DOD number cannot exceed 32 characters.

5. Set the DOD name If extension number need to be appended to the DID number click on "Add Extension".

**Note:** DOD name cannot exceed 32 characters.

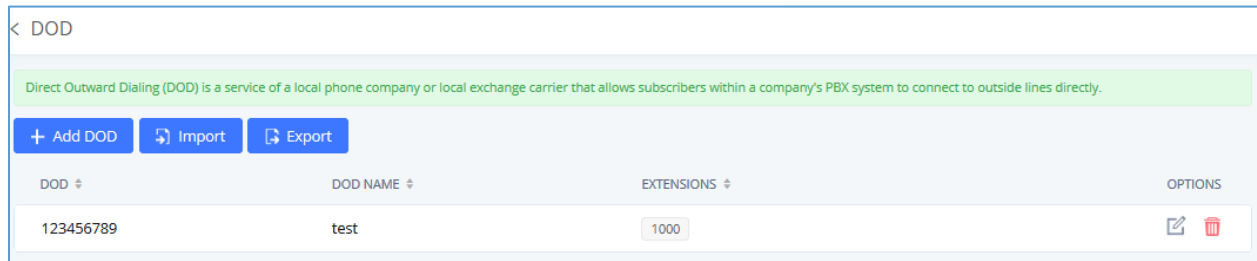
6. Select an extension from the "Available Extensions" list. Users have the option of selecting more than one extension. In this case, Company ABC would select the CEO's extension. After making the selection, click on the  button to move the extension(s) to the "Selected Extensions" list.



**Figure 111: DOD extension selection**

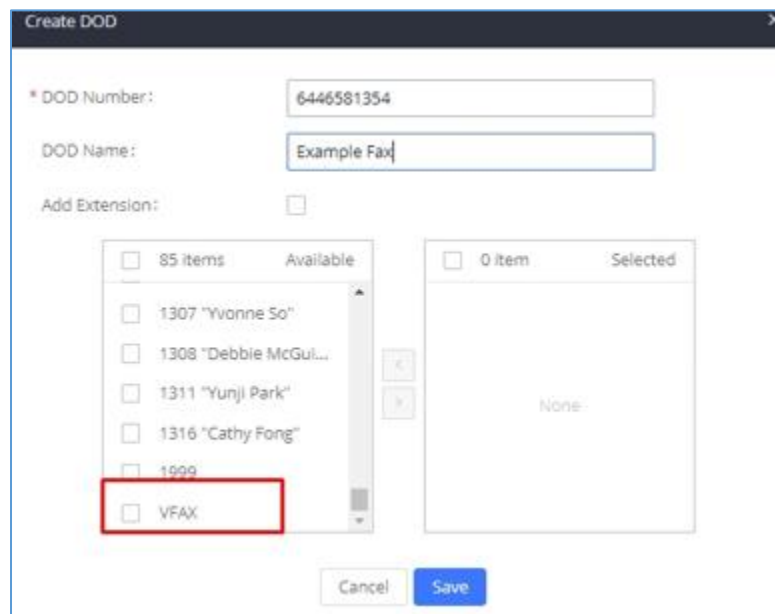
7. Click "Save" at the bottom.

Once completed, the user will return to the **Edit DOD** page that shows all the extensions that are associated to a particular DOD.



**Figure 112: Edit DOD**

DOD can also be assigned to the UCM's **Fax Sending** feature. To do this, select "VFAX" from the extension list when creating or editing a DOD number like shown below.



**Figure 113: Fax Sending DOD**

### DOD Import/Export

UCM62xx now supports to import/export DOD CSV file for an easy configuration.

- To Import DOD CSV file, click on "**Import**".

**Note:** the file must contain and respect the following columns: DOD Number, DOD Name, Add extension, Local Member, LDAP Members.



A	B	C	D	E
DOD Number	DOD Name	Add Extensior	Local Member	Ldap Members
123456789	test	no	1000	

Figure 114: DOD Import file

- To export the DOD file, users can click on “Export”.



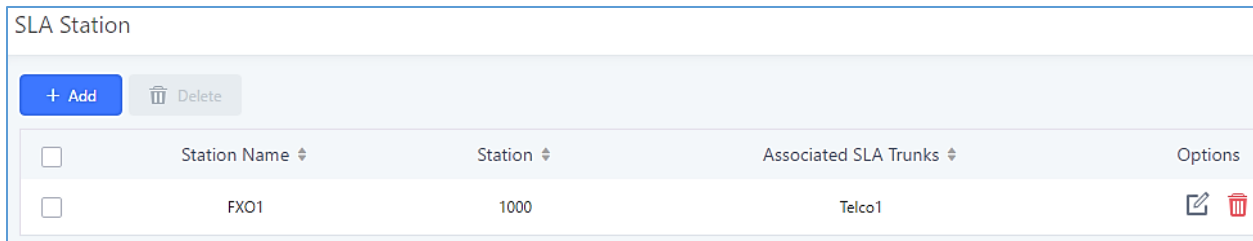


## SLA STATION

UCM6510 supports SLA (Shared Line Appearance) that allows mapping the key with LED on a multi-line phone to different external lines. When there is an incoming call and the phone starts to ring, the LED on the key will flash in red and the call can be picked up by pressing this key. This allows users to know if the line is occupied or not. The SLA function on the UCM6510 is similar to BLF but SLA is used to monitor external line i.e., analog trunk on the UCM6510. Users could configure the phone with BLF mode on the MPK to monitor the analog trunk status or press the line key pick up call from the analog trunk on the UCM6510.

### Create/Edit SLA Station

SLA Station can be configured on Web GUI → **Extension/Trunk** → **SLA Station**.



<input type="checkbox"/>	Station Name ↕	Station ↕	Associated SLA Trunks ↕	Options
<input type="checkbox"/>	FX01	1000	Telco1	

Figure 115: SLA Station

- Click on “Create New SLA Station” to add an SLA Station.
- Click on to edit the SLA Station. The following table shows the SLA Station parameters.
- Click on to delete the SLA Station.

Table 65: SLA Station Configuration Parameters

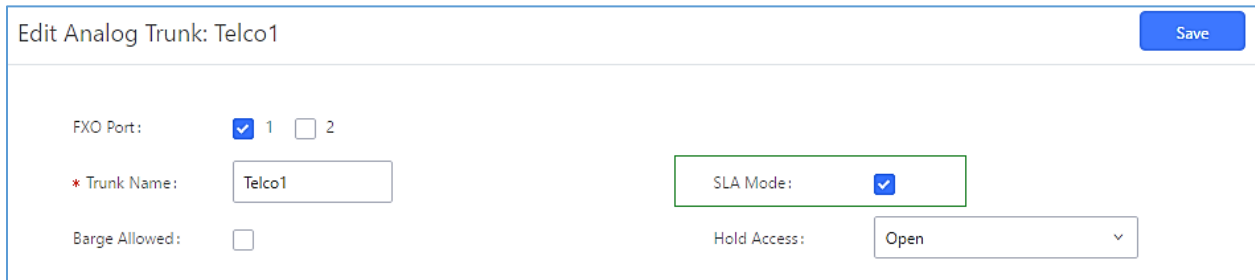
	Configure a name to identify the SLA Station.
<b>Station</b>	Specify a SIP extension as a station that will be using SLA.
<b>Available SLA Trunks</b>	Existing Analog Trunks with SLA Mode enabled will be listed here.
<b>Selected SLA Trunks</b>	Select a trunk for this SLA from the Available SLA Trunks list. Click on     to arrange the order. If there are multiple trunks selected, when there are calls on those trunks at the same time, pressing the LINE key on the phone will pick up the call on the first trunk here.
<b>SLA Station Options</b>	
<b>Ring Timeout</b>	Configure the time (in seconds) to ring the station before the call is considered unanswered. No timeout is set by default. If set to 0, there will be no timeout.



<b>Ring Delay</b>	Configure the time (in seconds) for delay before ringing the station when a call first coming in on the shared line. No delay is set by default. If set to 0, there will be no delay.
<b>Hold Access</b>	This option defines the competence of the hold action for one particular trunk. If set to “open”, any station could hold a call on that trunk or resume one held session; if set to “private”, only the station that places the trunk call on hold could resume the session. The default setting is “open”.

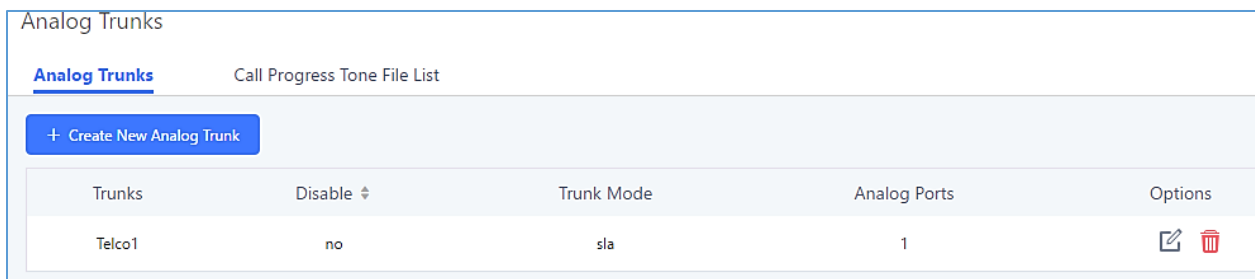
## Sample Configuration



1. On the UCM6510, go to Web GUI → **Extension/Trunk** → **Analog Trunks** page. Create analog trunk or edit the existing analog trunk. Make sure “SLA Mode” is enabled for the analog trunk. Once enabled, this analog trunk will be only available for the SLA stations created under Web GUI → **Extension/Trunk** → **SLA Station** page.



**Figure 116: Enable SLA Mode for Analog Trunk**

Click on “Save”. The analog trunk will be listed with trunk mode “SLA”.





Trunks	Disable	Trunk Mode	Analog Ports	Options
Telco1	no	sla	1	 

**Figure 117: Analog Trunk with SLA Mode Enabled**

2. On the UCM6510, go to Web GUI → **Extension/Trunk** → **SLA Station** page, click on “Create New SLA Station”. Please refer to section [\[Create/Edit SLA Station\]](#) for the configuration parameters. Users can create one or more SLA stations to monitor the analog trunk. The following figure shows two stations, 1002 and 1005, are configured to be associated with SLA trunk “fxo1”.



<input type="checkbox"/>	Station Name ↕	Station ↕	Associated SLA Trunks ↕	Options
<input type="checkbox"/>	SLA1	1005	Telco1	 

**Figure 118: SLA Example - SLA Station**

- On the SIP phone 1, configure to register UCM6510 extension 1002. Configure the MPK as BLF mode and the value must be set to “extension\_trunkname”, which is 1002\_fxo1 in this case.
- On the SIP phone 2, configure to register UCM6510 extension 1005. Configure the MPK as BLF mode and value must be set to “extension\_trunkname”, which is 1005\_fxo1 in this case.

	Mode	Account	Description	Value
MPK 1	Busy Lamp Field (BLF) ▼	Account 2 ▼	1005_fxo1	1005_fxo1

**Figure 119: SLA Example - MPK Configuration**

Now the SLA station is ready to use. The following functions can be achieved by this configuration.

- **Making an outbound call from the station/extension, using LINE key**  
 When the extension is in idle state, pressing the line key for this extension on the phone to off hook. Then dial the station’s extension number, for example, dial 1002 on phone 1 (or dial 1005 on phone 2), to hear the dial tone. Then the users could dial external number for the outbound call.
- **Making an outbound call from the station/extension, using BLF key**  
 When the extension is in idle state, pressing the MPK and users could dial external numbers directly.
- **Answering call using LINE key**  
 When the station is ringing, pressing the LINE key to answer the incoming call.
- **Barging-in active call using BLF key**  
 When there is an active call between an SLA station and an external number using the SLA trunk, other SLA stations monitoring the same trunk could join the call by pressing the BLF key if “Barge Allowed” is enabled for the analog trunk.
- **Hold/UnHold using BLF key**  
 If the external line is previously put on hold by an SLA station, another station that monitors the same SLA trunk could UnHold the call by pressing the BLF key if “Hold Access” is set to “open” on the analog trunk and the SLA station.



# CALL ROUTES







## Outbound Routes

### Configuring Outbound Routes

In the UCM6510, an outgoing calling rule pairs an extension pattern with a trunk used to dial the pattern. This allows different patterns to be dialed through different trunks (e.g., "Local" 7-digit dials through an FXO while "Long distance" 10-digit dials through a low-cost SIP trunk). Users can also set up a failover trunk to be used when the primary trunk fails.

**Note:** UCM6510 supports now 500 Outbound routes.

Go to Web GUI→**Extension/Trunk**→**Outbound Routes** to add and edit outbound rules.

- Click on "Create New Outbound Rule" to add a new outbound route.
- Click on  to edit the outbound route.
- Click on  to delete the outbound route.
- On the UCM6510, the outbound route priority is based on "Best matching pattern". For example, the UCM6510 has outbound route A with pattern 1xxx and outbound route B with pattern 10xx configured. When dialing 1000 for outbound call, outbound route B will always be used first. This is because pattern 10xx is a better match than pattern 1xxx. Only when there are multiple outbound routes with the same pattern configured, users can click on     to move the outbound route up/down to arrange the priority among those outbound routes.

**Table 66: Outbound Route Configuration Parameters**

<b>Calling Rule Name</b>	Configure the name of the calling rule (e.g., local, long_distance, and etc). Letters, digits, _ and - are allowed.
<b>Pattern</b>	<ul style="list-style-type: none"> <li>• All patterns are prefixed with the "_".</li> <li>• Special characters:  <b>X</b>: Any Digit from 0-9.  <b>Z</b>: Any Digit from 1-9.  <b>N</b>: Any Digit from 2-9.            ".": Wildcard. Match one or more characters.            "(": Wildcard. Match zero or more characters immediately.            Example: [12345-9] - Any digit from 1 to 9.</li> </ul>



	<p><b>Notes:</b></p> <ul style="list-style-type: none"> <li>▪ Multiple patterns can be used. Each pattern should be entered in new line.</li> <li>▪ Users can add comments to the end of patterns to better organize and keep track of complex rules by typing “/” and “*/” before and after each comment respectively.</li> <li>▪ <u>Example:</u>          _X.          _NNXXNXXXXX /* 10-digit long distance */          _818X. /* Any number with leading 818 */</li> </ul>
<b>Disable This Route</b>	After creating the outbound route, users can choose to enable and disable it. If the route is disabled, it will not take effect anymore. However, the route settings will remain in UCM. Users can enable it again when it is needed.
<b>Password</b>	Configure the password for users to use this rule when making outbound calls.
<b>Call Duration Limit</b>	Once call duration limit is enabled, it will set the maximum duration of call-blocking.
<b>Maximum Call Duration</b>	User can customize the maximum call duration (in seconds) that is allowed for the outbound call. By default, this value is set to 0 means there is no limit for the call duration.
<b>Warning Time</b>	This option will give caller warning when call duration is approaching to its limit. If the warning time is set to ‘y’, the warning tone will be played to caller when y seconds is left to end the call by UCM.
<b>Warning Repeat Interval</b>	Once this option is set to ‘z’, it will repeatedly be warning caller every z seconds after the first warning.
<b>PIN Groups</b>	If selected, the Password, Privilege Level and Enable Filter on Source Caller ID will not take effect. For more details, refer to [PIN Groups] section.
<b>PIN Groups with Privilege Level</b>	If enabled and PIN Groups are used, Privilege Levels and Filter on Source Caller ID will also be applied.
<b>Password</b>	Configure the password for users to use this rule when making outbound calls.
<b>Privilege Level</b>	Select privilege level for the outbound rule. <ul style="list-style-type: none"> <li>• <b>Internal:</b> The lowest level required. All users can use this rule.</li> </ul>



	<ul style="list-style-type: none"> <li>• <b>Local:</b> Users with Local, National, or International level are allowed to use this rule.</li> <li>• <b>National:</b> Users with National or International level are allowed to use this rule.</li> <li>• <b>International:</b> The highest level required. Only users with international level can use this rule.</li> </ul> <p>The default setting is "Disable". Please be aware of the potential security risks when using "Internal" level, which means all users can use this outbound rule to dial out from the trunk.</p>
<b>Enable Filter on Source Caller ID</b>	<p>When enabled, users could specify extensions allowed to use this outbound route. "Privilege Level" is automatically disabled if using "Enable Filter on Source Caller ID".</p> <p>The following two methods can be used at the same time to define the extensions as the source caller ID.</p> <ol style="list-style-type: none"> <li>1. Select available extensions/extension groups from the left to the right. This allows users to specify arbitrary single extensions available in the PBX.</li> <li>2. Custom Dynamic Route: define the pattern for the source caller ID. This allows users to define extension range instead of selecting them one by one. <ul style="list-style-type: none"> <li>• All patterns are prefixed with the "_".</li> <li>• Special characters:  <b>X:</b> Any Digit from 0-9.  <b>Z:</b> Any Digit from 1-9.  <b>N:</b> Any Digit from 2-9.  <b>":</b> Wildcard. Match one or more characters.  <b>!":</b> Wildcard. Match zero or more characters immediately.</li> </ul> <p>Example: [12345-9] - Any digit from 1 to 9.</p> <p><u>Note:</u> Multiple patterns can be used. Patterns should be separated by comma ",". Example: _X. , _NNXXNXXXXX , _818X.</p> </li> </ol>
<b>Outbound Route CID</b>	<p>Attempt to use the configured outbound route CID. This CID will not be used if DOD is configured. It is formatted as "name&lt;number&gt;" or "&lt;number&gt;" or "number".</p>



### Send This Call Through Trunk

<b>Use Trunk</b>	Select the trunk for this outbound rule.
<b>Strip</b>	<p>Allows the user to specify the number of digits that will be stripped from the beginning of the dialed string before the call is placed via the selected trunk.</p> <p><u>Example:</u></p> <p>The users will dial 9 as the first digit of a long-distance calls. However, 9 should not be sent out via analog lines and the PSTN line. In this case, 1 digit should be stripped before the call is placed.</p>
<b>Prepend</b>	<p>Specify the digits to be prepended before the call is placed via the trunk.</p> <p>Those digits will be prepended after the dialing number is stripped.</p>

### Use Failover Trunk

<b>Failover Trunk</b>	<p>Failover trunks can be used to ensure calls can still be made in the scenario that the main trunk is congested or down. UCM6510 support up to 10 failover trunks.</p> <p><u>Example:</u> The user's primary trunk is a VoIP trunk and the user would like to use the PSTN when the VoIP trunk is not available. The PSTN trunk can be configured as the failover trunk of the VoIP trunk.</p>
<b>Strip</b>	<p>Allows the user to specify the number of digits that will be stripped from the beginning of the dialed string before the call is placed via the selected trunk.</p> <p><u>Example:</u></p> <p>The users will dial 9 as the first digit of a long-distance calls. However, 9 should not be sent out via analog lines and the PSTN line. In this case, 1 digit should be stripped before the call is placed.</p>
<b>Prepend</b>	<p>Specify the digits to be prepended before the call is placed via the trunk.</p> <p>Those digits will be prepended after the dialing number is stripped.</p>

### Time Condition

<b>Time Condition</b>	Outbound routes can be configured to use different trunks based on time conditions such as holidays, office times, specific times, etc.
-----------------------	---

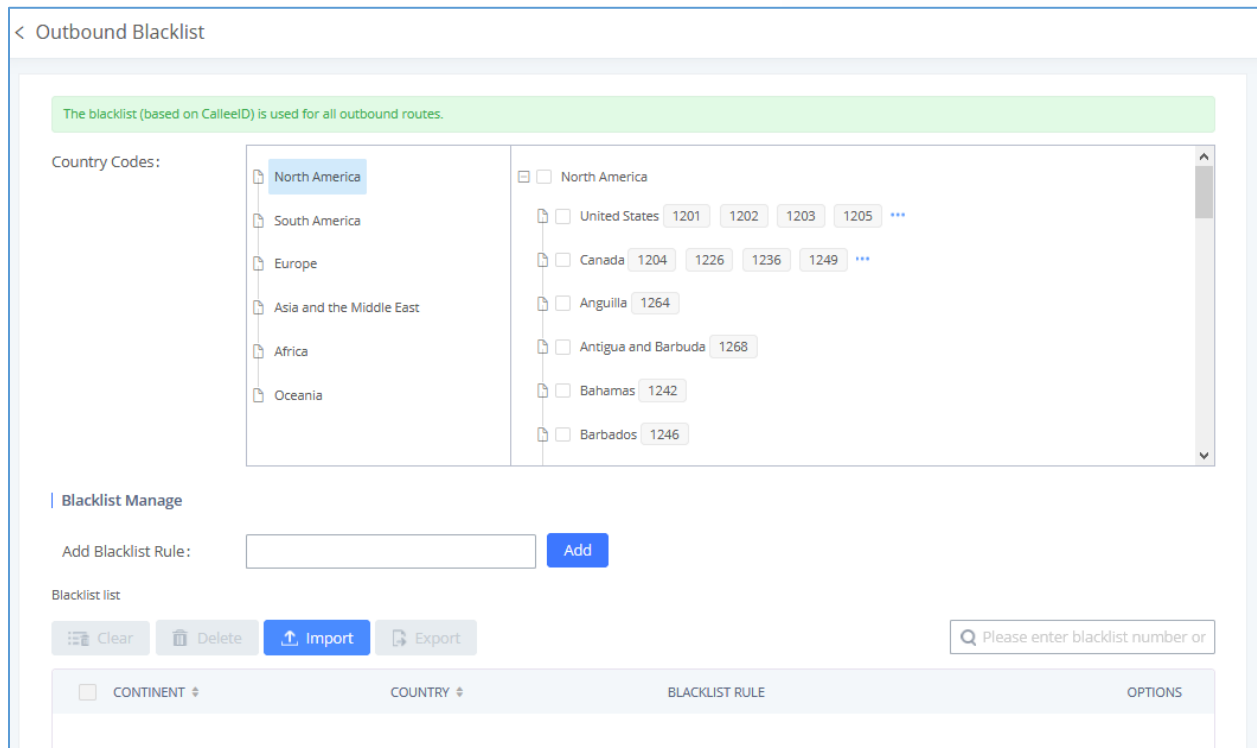
## Outbound Blacklist

The UCM6510 allows users to configure blacklist for outbound routes. If the dialing number matches the blacklist numbers or patterns, the outbound call will not be allowed. The outbound blacklist can be configured under UCM Web GUI → **Extension/Trunk** → **Outbound Routes: Outbound Blacklist**.

Users can configure number, pattern or select country code to add in the blacklist. Please note that the



blacklist settings apply to all outbound routes.



**Figure 120: Outbound Blacklist**

**Table 67: Blacklist Manage - Matching Rules**

Blacklist Manage	
<b>Add Blacklist Rule</b>	<p>Allows to define a rule based on number(s) or pattern(s) as blacklist entry. Pattern rules:</p> <p><b>N</b> : Any digit from 2-9</p> <p><b>X</b> : Any digit from 0-9</p> <p><b>Z</b> : Any digit from 1-9</p> <p><b>.</b> : Wildcard, matching one or more characters</p> <p><b>!</b> : Wildcard, matching zero or more characters immediately</p> <p><b>-</b> : Hyphens are used mainly to improve readability and are not involved in pattern matching.</p>

**Note:** Users can export outbound route blacklists and delete all blacklist entries. Additionally, users can also import blacklists for outbound routes.



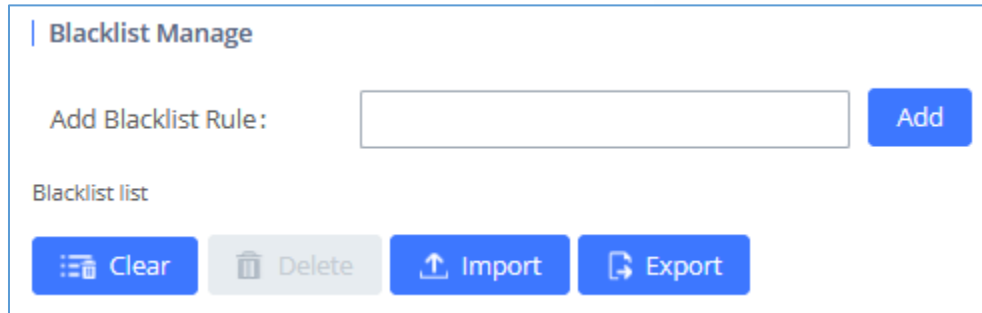


Figure 121: Blacklist Import/Export

## Scheduled Sync

Outbound Routes can be synced from a UTF-8 encoded CSV file located in the configured TFTP server. CSV files can be opened using programs such as Notepad and saved as a UTF-8 encoded file.

Table 68: Sync Outbound Routes

Sync Outbound Routes	
<b>Scheduled Sync</b>	Enable Scheduled Sync option.
<b>Server Address</b>	Enter the TFTP server address (e.g., 192.168.1.2:69).
<b>File Name</b>	Enter the file name.
<b>Sync Time</b>	Enter the sync time (24hr format). Valid range is 0-23.
<b>Sync Frequency</b>	Create new sync every x day(s). The valid range is 1 to 30.

## PIN Groups

The UCM6510 supports pin group. Once this feature is configured, users can apply pin group to specific outbound routes. When placing a call on pin protected outbound routes, caller will be asked to input the group pin number, this feature can be found on the webGUI→**Extension/Trunk**→**Outbound Routes**→**PIN Groups**.

Table 69: Outbound Routes/PIN Group

<b>Name</b>	Configure the name of the group
<b>Record In CDR</b>	Configure whether or not to display the used PIN group and name in a call's CDR entry.
<b>PIN Number</b>	Configure the PIN that will be required to dial out.



**PIN Name**

Configure the name of the PIN

Once user click on [PIN Groups](#) the following figure shows to configure the new PIN.

Create New PIN Group
Save

\* Name:

Record in CDR:

Members

\* PIN Number:

\* PIN Name:

✓ Save
✗ Cancel

PIN Number: 2020 PIN Name: John
✎ 🗑

**Figure 122: Create New PIN Group**

The following screenshot shows an example of created PIN Groups and members:

PIN Groups

+ Add
Choose file to upload

	Name	Record in CDR	Options
-	GSEMEA	yes	✎ 🗑

	PIN Number	PIN Name
	2020	John
	2025	Emily
	3009	Jane

**Figure 123: PIN members**


**Edit Outbound Rule: National** Save

---

\* Calling Rule Name:

Disable This Route:

Password:

\* Pattern:

PIN Groups:

Privilege Level:

**Figure 124: Outbound PIN**

If pin group CDR is enabled, the call with PIN group information will be displayed as part of CDR under Account Code field.

**CDR**

Delete All
 Download All Records
 Download Search Result (s)
 Automatic Download Settings

Status	Call from	Call to	Action Type	Start Time	Talk Time	Account Code
+	1002	7946541 [Trunk: BranchOffice]	DIAL	2017-05-05 04:59:51	0:00:08	Emily/GSEMEA
+	1002	7654654 [Trunk: BranchOffice]	DIAL	2017-05-05 04:59:12	0:00:06	Jane/GSEMEA
+	1002	7564654 [Trunk: BranchOffice]	DIAL	2017-05-05 04:58:38	0:00:06	John/GSEMEA

**Figure 125: CDR Record**

**- Importing PIN Groups from CSV files:**

User can also import PIN Groups by uploading CSV files for each group. To do this:

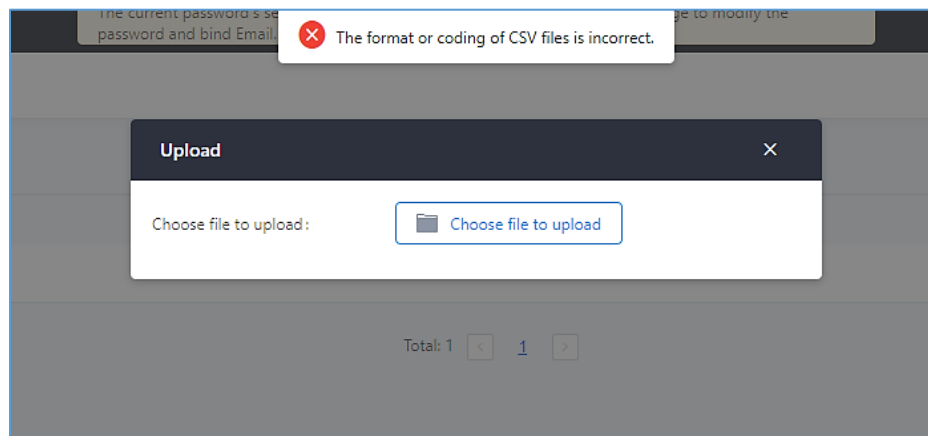
1. Navigate to **Extension/Trunk** → **Outbound Routes** → **PIN Groups** and click on the “Choose file to upload” button.





**Figure 126: Importing PIN Groups from CSV files**

2. Select the CSV file to upload. Incorrect file formats and improperly formatted CSV files will result in error messages such as the one below:



**Figure 127: Incorrect CSV File**

3. To ensure a successful import, please follow the format in the sample image below

	A	B	C	D
1	ALPHA			
2	pin	pin_name		
3	1625	test1		
4	9497	test2		
5	5872	test3		
6				
7				

**Figure 128: CSV File Format**

- The top-left value (A1) is the PIN Group name. In this case, it is “ALPHA”.
- Row 2 contains the labels for the modifiable fields: pin and pin\_name. These values should not be changed and will cause an upload error otherwise.
- Rows 3+ contain the user-defined values with Column A holding the PINs and Column B holding the PIN names. PIN values must consist of at least four digits.
- Once the file is successfully uploaded, the entry will be added to the list of PIN Groups.


< PIN Groups

+ Add Upload

NAME	RECORD IN CDR	OPTIONS
▶ ALPHA	yes	
▶ PIN2	yes	

**Figure 129: CSV File Successful Upload**



### - Exporting PIN Groups from CSV files:

Press  button under “Options” to download/export PIN Group settings.

## Inbound Routes

Inbound routes can be configured via Web GUI→**Extension/Trunk**→**Inbound Routes**.

**Note:** UCM6510 now supports 5000 Inbound route.

- Click on "Create New Inbound Rule" button to add a new inbound route.
- Click on "Blacklist" button to configure blacklist for all inbound routes.
- Click on  to edit the inbound route.
- Click on  to delete the inbound route.



## Inbound Rule Configurations

**Table 70: Inbound Rule Configuration Parameters**

<b>Trunks</b>	Select the trunk to configure the inbound rule.								
<b>Pattern</b>	<ul style="list-style-type: none"> <li>All patterns are prefixed with the "_".</li> <li>Special characters:           <ul style="list-style-type: none"> <li><b>X</b>: Any Digit from 0-9.</li> <li><b>Z</b>: Any Digit from 1-9.</li> <li><b>N</b>: Any Digit from 2-9.</li> <li><b>"."</b>: Wildcard. Match one or more characters.</li> <li><b>"!"</b>: Wildcard. Match zero or more characters immediately.</li> </ul> </li> <li>Example: [12345-9] - Any digit from 1 to 9.</li> <li>There are two pattern fields: Pattern and CallerID           <ul style="list-style-type: none"> <li>➤ <b>Pattern</b>. Pattern: Specifies the pattern that the dialed number must satisfy to use the inbound route. Example: if the pattern is "_2xxx", the dialed number must be a four-digit number that starts with 2 in order for this route to be used.</li> <li>➤ <b>CallerID Pattern</b>: Specifies the CallerID pattern that callers must satisfy to use the inbound route. Example: if the CallerID pattern is "_1234", only callers with a CID of 1234 can use this route.</li> </ul> </li> </ul> <p><u>Notes:</u></p> <ul style="list-style-type: none"> <li>Multiple patterns can be used. Each pattern should be entered in new line.</li> <li>Users can add comments to the end of patterns to better organize and keep track of complex rules by typing "/" and "/" before and after each comment respectively.</li> <li>Example:</li> </ul> <table border="1" data-bbox="618 1331 1417 1507"> <thead> <tr> <th>Pattern</th> <th>CallerID Pattern</th> </tr> </thead> <tbody> <tr> <td>_X.</td> <td>1000</td> </tr> <tr> <td>_NNXXNXXXXX /* 10-digit long distance */</td> <td>1001</td> </tr> <tr> <td>_818X. /* Any number with leading 818 */</td> <td></td> </tr> </tbody> </table>	Pattern	CallerID Pattern	_X.	1000	_NNXXNXXXXX /* 10-digit long distance */	1001	_818X. /* Any number with leading 818 */	
Pattern	CallerID Pattern								
_X.	1000								
_NNXXNXXXXX /* 10-digit long distance */	1001								
_818X. /* Any number with leading 818 */									
<b>Disable This Route</b>	After creating the inbound route, users can choose to enable and disable it. If the route is disabled, it will not take effect anymore. However, the route settings will remain in UCM. Users can enable it again when it is needed.								
<b>Allowed to seamless transfer</b>	Allows the selected extension to use this function. If an extension is busy, and a mobile phone is bound to that extension, the mobile phone can pick up calls to that extension.								
<b>Alert-Info</b>	Configure the Alert-Info, when UCM6510 receives an INVITE request, the Alert-Info header field specifies an alternative ring tone to the UAS.								



<b>special ringing tone</b>	This option will allow users to choose the custom ring back tone to play when caller reaches the route.
<b>Fax Detection</b>	If enabled, fax signals from the trunk during a call will be detected.
<b>Fax Destination</b>	<p>Configures the destination of faxes.</p> <ul style="list-style-type: none"> <li>• <b>Extension:</b> Send the fax to the designated FXS/SIP extension (fax machine) or a FAX extension.</li> <li>• <b>Fax to Email:</b> Send the fax as an email attachment to the designated extension's email address. If the selected extension does not have an associated email address, it will be sent to the default email address configured in the Call Features → Fax/T.38 → Fax Settings page. <b>Note:</b> Please make sure the sending email address is correctly configured in System Settings → Email Settings.</li> </ul>
<b>Prepend Trunk Name</b>	If enabled, the trunk name will be added to the caller id name as the displayed caller id name.
<b>Block Collect Calls</b>	<p>If enabled, collect calls will be blocked.</p> <p><b>Note 1:</b> Collect calls are indicated by the header "P-Asserted-Service-Info: service-code=Backward Collect Call, P-Asserted-Service-Info: service-code=Collect Call".</p> <p><b>Note 2:</b> There is also a global setting for this option in the SIP Settings -&gt; General Settings page.</p>
<b>Set Caller ID Info</b>	Manipulates Caller ID (CID) name and/or number within the call flow to help identify who is calling. When enabled two field will show allowing to manipulate the CallerID Number and the Caller ID Name.
<b>CallerID Number</b>	<p>Configures the pattern-matching format to manipulate the numbers of incoming callers or to set a fixed CallerID number for calls that go through this inbound route.</p> <ul style="list-style-type: none"> <li>• <b>`\${CALLERID(num)}`:</b> Default value which indicates the number of an incoming caller (CID). The CID will not be modified.</li> <li>• <b>`\${CALLERID(num):n}`:</b> Skips the first n characters of a CID number, where n is a number.</li> <li>• <b>`\${CALLERID(num):-n}`:</b> Takes the last n characters of a CID number, where n is a number.</li> <li>• <b>`\${CALLERID(num):s:n}`:</b> Takes n characters of a CID number starting from s+1, where n is a number and s is a character position (e.g. `\${CALLERID(num):2:7}` takes 7 characters after the second</li> </ul>



	<p>character of a CID number).</p> <ul style="list-style-type: none"> <li>• <b>n\${CALLERID(num)}</b>: Prepends n to a CID number, where n is a number.</li> </ul>
<b>CallerID Name</b>	<p>Default string is <b>\${CALLERID(name)}</b> which means the name of an incoming caller, it is a pattern-matching syntax format.</p> <p><b>A\${CALLERID(name)}B</b> means Prepend a character 'A' and suffix a character 'B' to <b>\${CALLERID(name)}</b>.</p> <p>Not using pattern-matching syntax means setting fix name to incoming caller.</p>
<b>Enable Route-Level Inbound</b>	<p>Gives uses the ability to configure inbound mode per individual route. When enabled two fields will show allowing to set the Inbound mode and the Inbound mode Suffix.</p> <p><b>Note:</b> Global inbound mode must be enabled before users can configure route-level inbound mode</p>
<b>Inbound Mode</b>	<p>Choose the inbound mode for this route.</p> <p><b>Note:</b> Toggling the global inbound mode will not affect routes that have Route-level Inbound Mode enabled. If all routes have the option enabled, toggling the global inbound mode via BLF will trigger a voice prompt indicating that none of the routes will be affected by the global inbound mode change.</p>
<b>Inbound Mode Suffix</b>	<p>Dial "Global Inbound Mode feature code + Inbound Mode Suffix" or a route's assigned suffix to toggle the route's inbound mode.</p> <p>The BLF subscribed to the inbound mode suffix can monitor the current inbound mode.</p>
<b>Inbound Multiple Mode</b>	<p>Multiple mode allows user to switch between destinations of the inbound rule by feature codes. Configure related feature codes as described in <b>[Inbound Route: Multiple Mode]</b>. If this option is enabled, user can use feature code to switch between different modes/destinations.</p>
<b>Dial Trunk</b>	<p>This option shows up only when "By DID" is selected. If enabled, the external users dialing in to the trunk via this inbound route can dial outbound call using the UCM6510's trunk.</p>





<b>Privilege Level</b>	<p>This option shows up only when "By DID" is selected.</p> <ul style="list-style-type: none"> <li>• <b>Disable:</b> Only the selected Extensions or Extension Groups are allowed to use this rule, when enabled Filter on Source Caller ID.</li> <li>• <b>Internal:</b> The lowest level required. All users are allowed to use this rule, check this level might be risky for security purpose.</li> <li>• <b>Local:</b> User with Local level, National or International level are allowed to use this rule.</li> <li>• <b>National:</b> Users with National or International Level are allowed to use this rule.</li> <li>• <b>International:</b> The highest level required. Only users with international level are allowed to use this rule.</li> </ul>
<b>Allowed DID Destination</b>	<p>This option shows up only when "By DID" is selected. This controls the destination that can be reached by the external caller via the inbound route. The DID destination are:</p> <ul style="list-style-type: none"> <li>• Extension</li> <li>• Conference</li> <li>• Call Queue</li> <li>• Ring Group</li> <li>• Paging/Intercom Groups</li> <li>• IVR</li> <li>• Voicemail Groups</li> <li>• Fax Extension</li> <li>• Dial By Name</li> <li>• All</li> </ul>
<b>Default Destination</b>	<p>Select the default destination for the inbound call.</p> <ul style="list-style-type: none"> <li>• Extension</li> <li>• Voicemail</li> <li>• Conference Room</li> <li>• Call Queue</li> <li>• Ring Group</li> <li>• Paging/Intercom</li> <li>• Voicemail Group</li> <li>• Fax</li> <li>• DISA</li> <li>• IVR</li> <li>• External Number</li> <li>• By DID</li> </ul>



	<p>When "By DID" is used, the UCM6510 will look for the destination based on the number dialed, which could be local extensions, conference, call queue, ring group, paging/intercom group, IVR, voicemail groups and Fax extension as configured in "DID destination". If the dialed number matches the DID pattern, the call will be allowed to go through.</p> <ul style="list-style-type: none"> <li>• Dial By Name</li> <li>• Callback</li> <li>• Announcement</li> </ul>
<b>Strip</b>	Specify the number of digits to strip from the beginning of the DID. This is used when "By DID" is selected in "Default Destination".
<b>Prepend</b>	Specify the digits to be prepended before the call is placed via the trunk. Those digits will be prepended after the dialing number is stripped.
<b>Time Condition</b>	
<b>Start Time</b>	Select the start time "hour:minute" for the trunk to use the inbound rule.
<b>End Time</b>	Select the end time "hour:minute" for the trunk to use the inbound rule.
<b>Frequency</b>	<p>Select either "By Week" or "By Month" for the time condition.</p> <p>If "By Week" is selected, select the weekdays that the time condition will be used.</p> <p>If "By Month" is selected, select the months that the time condition will be used. Next, select either "Week" or "Day".</p> <p>(1) If "Week" is selected, choose the weekdays of the month that the time condition will be used.</p> <p>(2) If "Day" is selected, choose the specific days of the month that the time condition will be used.</p>
<b>Destination</b>	<p>Select the destination for the inbound call under the defined time condition.</p> <ul style="list-style-type: none"> <li>• Extension</li> <li>• Voicemail</li> <li>• Conference Room</li> <li>• Call Queue</li> <li>• Ring Group</li> <li>• Paging/Intercom</li> <li>• Voicemail Group</li> <li>• Fax</li> <li>• DISA</li> <li>• IVR</li> <li>• By DID</li> </ul> <p>When "By DID" is used, the UCM6510 will look for the destination based on the number dialed, which could be local extensions, conference, call queue, ring group, paging/intercom group, IVR, voicemail groups and Fax extension as configured in "DID destination". If the dialed number</p>

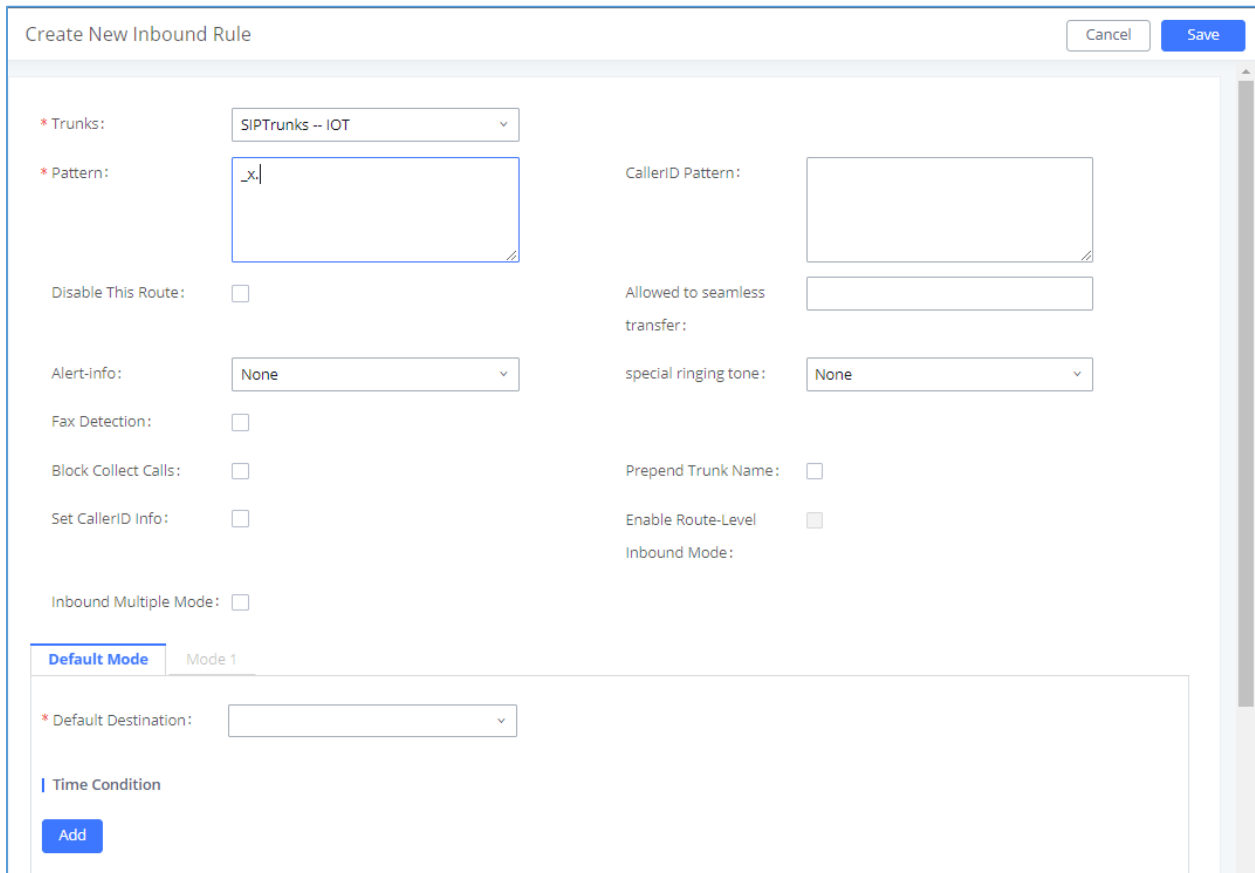


matches the DID pattern, the call will be allowed to go through. Configure the number of digits to be stripped in "Strip" option.

- Dial By Name
- External Number
- Callback
- Announcement

## Inbound Route: Prepend Example

UCM6510 now allows user to prepend digits to an inbound DID pattern, with strip taking precedence over prepend. With the ability to prepend digits in inbound route DID pattern, user no longer needs to create multiple routes for the same trunk in order to route calls to different extensions.



The screenshot shows the 'Create New Inbound Rule' configuration window. Key fields include:

- \* Trunks:** SIPTrunks -- IOT
- \* Pattern:** \_x|
- CallerID Pattern:** (Empty)
- Disable This Route:**
- Alert-info:** None
- Allowed to seamless transfer:** (Empty)
- Fax Detection:**
- special ringing tone:** None
- Block Collect Calls:**
- Prepend Trunk Name:**
- Set CallerID Info:**
- Enable Route-Level Inbound Mode:**
- Inbound Multiple Mode:**
- \* Default Destination:** (Empty)
- Time Condition:** (Collapsed)

**Figure 130: Inbound Route feature: Prepend**

The following example demonstrates the process:

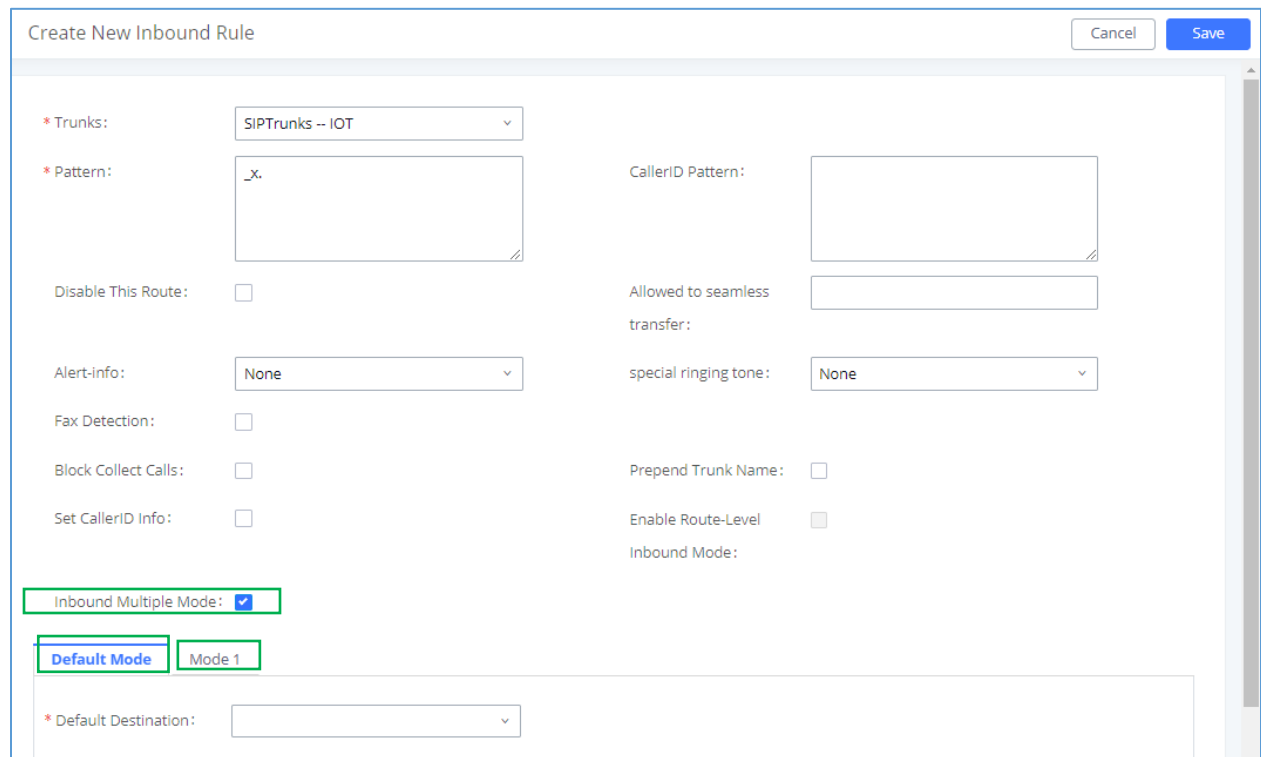
1. If Trunk provides a DID pattern of 18005251163.
2. If **Strip** is set to 8, UCM6510 will strip the first 8 digits.



3. If **Prepend** is set to 2, UCM6510 will then prepend a 2 to the stripped number, now the number become 2163.
4. UCM6510 will now forward the incoming call to extension 2163.

### Inbound Route: Multiple Mode

In UCM6510, user can configure inbound route to enable multiple mode to switch between different destinations. The inbound multiple mode can be enabled under Inbound Route settings.



The screenshot shows the 'Create New Inbound Rule' configuration interface. Key elements include:

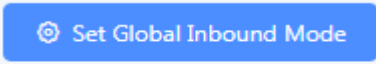
- Trunks:** A dropdown menu set to 'SIPTrunks -- IOT'.
- Pattern:** A text input field containing '\_X.'.
- CallerID Pattern:** An empty text input field.
- Disable This Route:** An unchecked checkbox.
- Alert-info:** A dropdown menu set to 'None'.
- Fax Detection:** An unchecked checkbox.
- Block Collect Calls:** An unchecked checkbox.
- Set CallerID Info:** An unchecked checkbox.
- Allowed to seamless transfer:** An empty text input field.
- special ringing tone:** A dropdown menu set to 'None'.
- Prepend Trunk Name:** An unchecked checkbox.
- Enable Route-Level:** An unchecked checkbox.
- Inbound Mode:** A section containing a checked 'Inbound Multiple Mode' checkbox, two buttons ('Default Mode' and 'Mode 1'), and a 'Default Destination' dropdown menu.

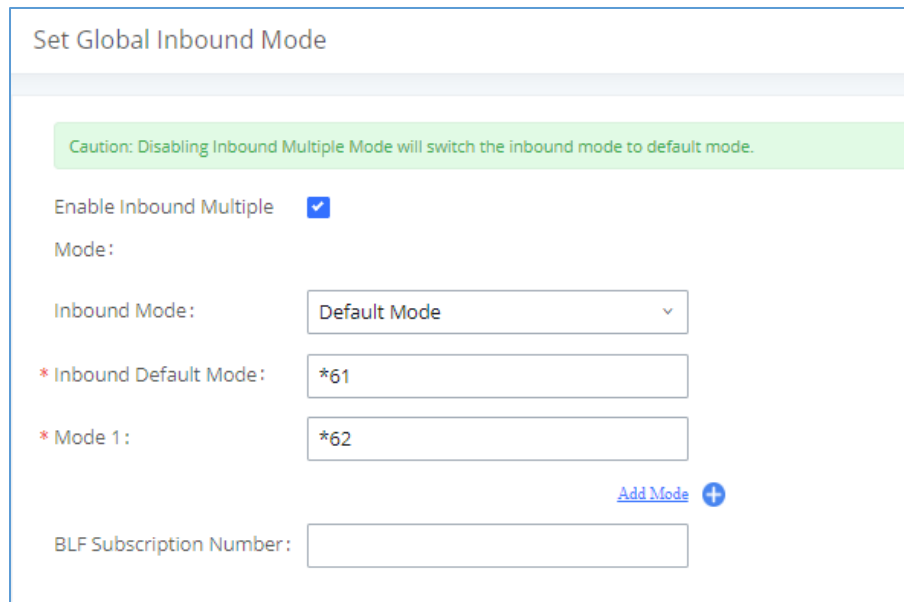
**Figure 131: Inbound Route - Multiple Mode**

When Multiple Mode is enabled for the inbound route, the user can configure a “Default Destination” and a “Mode 1” destination for all routes. By default, the call coming into this inbound route will be routed to the default destination.

SIP end devices that have registered on the UCM6510 can dial feature code \*62 to switch to inbound route “Mode 1” and dial feature code \*61 to switch back to “Default Destination”. Switching between different mode can be easily done without Web GUI login.

For example, the customer service hotline destination has to be set to a different IVR after 7PM. The user can dial \*62 to switch to “Mode 1” with that IVR set as the destination before off work. To customize feature

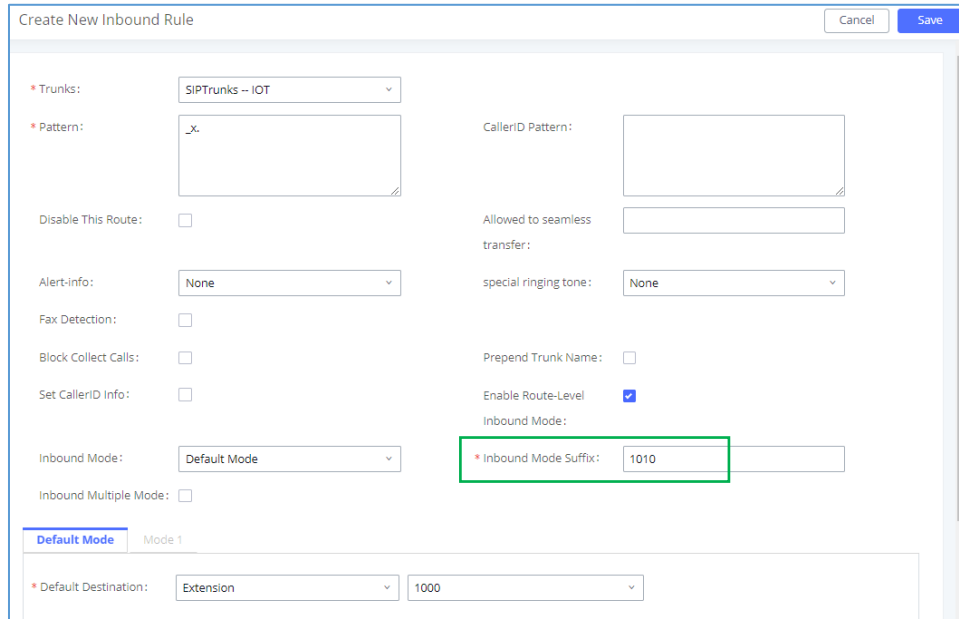
codes for “Default Mode” and “Mode 1”, click on  under “Inbound Routes” page, check “Enable Inbound Multiple Mode” option and change “Inbound Default Mode” and “Inbound Mode 1” values (By default, \*61 and \*62 respectively).



**Figure 132: Inbound Route - Multiple Mode Feature Codes**

### **Inbound Route: Route-Level Mode**

In the UCM6510, users can enable Route-Level Inbound Mode to switch between different destinations for each individual inbound route. The inbound Route-Level mode can be enabled under Inbound Route settings.



**Figure 133: Inbound Route - Route-Level Mode**

Global inbound mode must be enabled before configuring Route-Level Inbound Mode. Additionally, the Mode 1 must be configured as well.

When Route-Level Inbound Mode is enabled, the user can configure a “Default Destination” and a “Mode 1” destination for each specific route. By default, the call coming into this specific inbound route will be routed to the default destination.

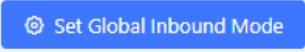
Users can toggle the route’s inbound mode by dialing "Global Inbound Mode feature code + Inbound Mode Suffix” and the current inbound route can be monitored by subscribing a BLF to the Inbound Mode Suffix.

For example, Inbound Default Mode feature code is set to \*61 and the Inbound Mode suffix for route 1 is set to 1010. To switch the mode of route 1 to Default Mode, users can dial \*611010.

**Note:** Toggling the global inbound mode will not affect routes that have *Route-level Inbound Mode* enabled. If all routes have the option enabled, toggling the global inbound mode via BLF will trigger a voice prompt indicating that none of the routes will be affected by the global inbound mode change.

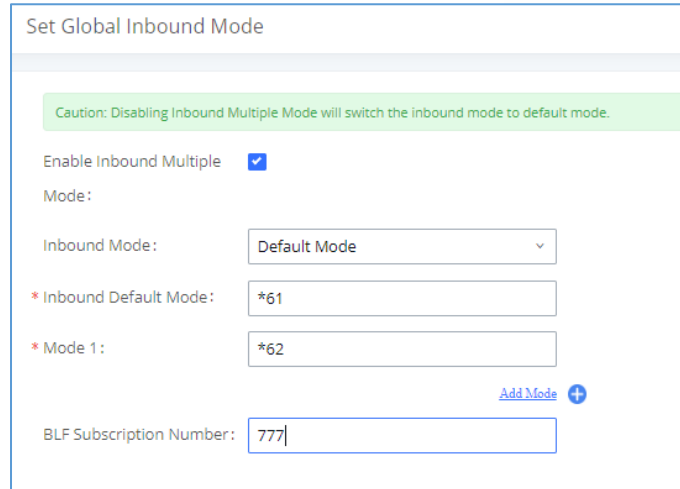
### **Inbound Route: Inbound Mode BLF Monitoring**

Users can assign MPKs and VPKs to monitor and toggle the current global inbound mode of the UCM. To do this, please refer to the following steps:

1. Access the UCM web GUI and navigate to Extension/Trunk->Inbound Routes.
2. Click on the  button and enable Inbound Multiple Mode.



3. Edit the subscribe number field to the desired BLF value.



**Figure 134: Global Inbound Mode**

4. Configure the BLF value on a phone's MPK/VPK. As an example, a GXP2140 with the BLF configured will show the Inbound Mode status on its screen once configured. The 777 BLF is lit green, indicating that the current inbound mode is "Default Mode".



**Figure 135 : Inbound Mode - Default Mode**

5. Pressing the key will toggle the inbound mode to "Mode 1", and the button's color will change to red.

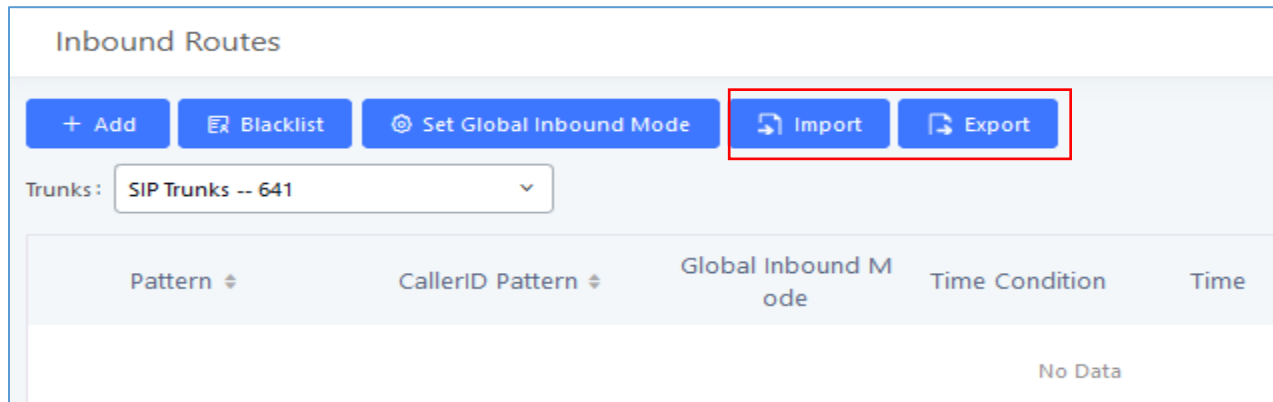


**Figure 136 : Inbound Mode - Mode 1**



## Inbound Route: Import/Export Inbound Route

Users can now import and export inbound routes to quickly set up inbound routing on a UCM or to back up an existing configuration. An exported inbound route configuration can be directly imported without needing any manual modifications.



**Figure 137: Import/Export Inbound Route**

The imported file should be on CSV format and using UTF-8 encoding, the imported file should contain below columns, and each column should be separated by a comma (It is recommended to use Notepad++ for the imported file creation):

- Disable This Route: Yes/No.
- Pattern: Always prefixed with \_
- CallerID Pattern: Always prefixed with \_
- Prepend Trunk Name: Yes/No.
- Prepend User Defined Name Enable: Yes/No.
- Prepend User Defined Name: A string.
- Alert-info: None, Ring 1, Ring 2... User should enter an Alert-info string following the values we have in the Inbound route Alert-Info list.
- Allowed to seamless transfer: [Extension\_number]
- Fax Detection: No, Yes.
- Fax Type: Extension, Fax to Email.
- Fax Destination: [Extension\_number] or [Email address]
- Inbound Multiple Mode: Yes/No.
- Default Destination: By DID, Extension, Voicemail... User should enter a Default Destination string following the values we have in the Inbound route Default Destination list.
- Destination: An Extension number, Ring Group Extension...
- Default Time Condition.
- Mode 1: By DID, Extension, Voicemail... User should enter a Default Destination string following the values we have in the mode 1 Default Destination list.
- Mode 1 Destination: An Extension number, Ring Group Extension...
- Mode 1 Time Condition.





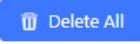



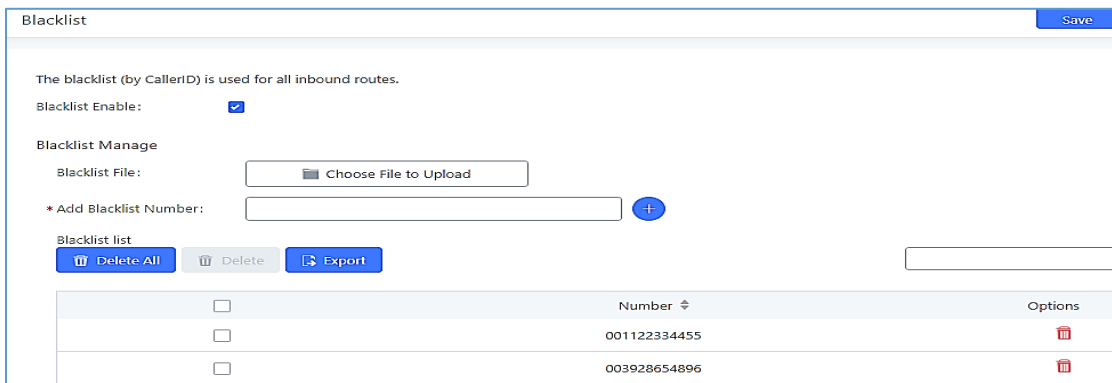
## Fax with Two Media

Since UCM's system is now based on Asterisk 13, fax re-invites that negotiate with multiple codecs are now supported. If a re-invite contains both T.38 and PCMU/PCMA codecs, T.38 will be prioritized.

## Blacklist Configurations

In the UCM6510, Blacklist is supported for all inbound routes. Users could enable the Blacklist feature and manage the Blacklist by clicking on "Blacklist".

- Select the checkbox for "Blacklist Enable" to turn on Blacklist feature for all inbound routes. Blacklist is disabled by default.
- Enter a number in "Add Blacklist Number" field and then click  to add to the list. Anonymous can also be added as a Blacklist Number.
- To remove a number from the Blacklist, select the number in "Blacklist list" and click on  or click on  button to remove all the numbers on the blacklist.
- User can also export the inbound route blacklist by pressing on  button.




Blacklist

The blacklist (by CallerID) is used for all inbound routes.




Blacklist Enable:

Blacklist Manage

Blacklist File:  Choose File to Upload

\* Add Blacklist Number:  

Blacklist list



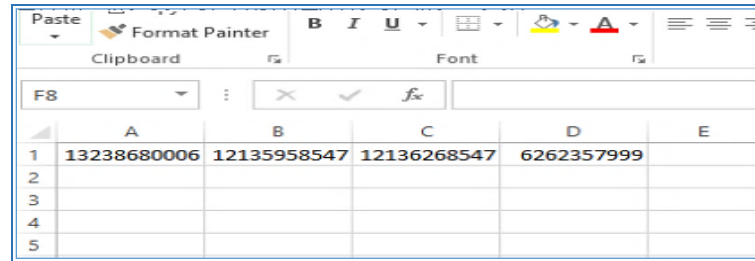
<input type="checkbox"/>	Number	Options
<input type="checkbox"/>	001122334455	
<input type="checkbox"/>	003928654896	

Figure 138: Blacklist Configuration Parameters

- To add blacklist number in batch, click on "choose file to upload" to upload blacklist file in csv format. The supported csv format is as below.



	A	B	C	D	E
1	13238680006	12135958547	12136268547	6262357999	
2					
3					
4					
5					

Figure 139: Blacklist csv File

---

 **Note:**

- Users could also add a number to the Blacklist or remove a number from the Blacklist by dialing the feature code for "Blacklist Add" (default: \*40) and "Blacklist Remove" (default: \*41) from an extension. The feature code can be configured under Web GUI→**Call Features**→**Feature Codes**.
  - Starting with 1.0.20.x, users can enter patterns to blacklist blocks of numbers.
- 





## CONFERENCE

The UCM6510 supports Conference rooms allowing 64 participants with up to 8 bridged rooms at the same time. The conference room configurations can be accessed under Web GUI → **Call Features** → **Conference**.

In this page, users could create, edit, view, invite, manage the participants and delete conference rooms. The conference room status and conference call recordings (if recording is enabled) will be displayed in this web page as well.

### Conference room Configurations

- Click on "Create New Conference Room" to add a new conference room.
- Click on  to edit the conference room.
- Click on  to delete the conference room.

**Table 71: Conference room Configuration Parameters**

<b>Extension</b>	Configure the conference number for the users to dial into the conference. <b>Note:</b> The conference extension number can contain up to 64 characters.
<b>Password</b>	When configured, the users who would like to join the conference call must enter this password before accessing the conference room.  <b>Notes:</b> <ul style="list-style-type: none"> <li>• If "Public Mode" is enabled, the password is not required to join the conference room thus this field is invalid.</li> <li>• The password must contain at least 4 characters.</li> <li>• Conference extension number can no longer be used as the conference password if Strong Password is enabled.</li> </ul>
<b>Host Password</b>	Configure the password to join the conference room as host. Conference host can manage the conference call via IVR (if "Enable Caller Menu" is enabled) as well as invite other parties to join the conference by dialing "0" (permission required from the invited party) or "1" (permission not required from the invited party) during the conference call.  <b>Notes:</b> <ul style="list-style-type: none"> <li>• If "Public Mode" is enabled, the password is not required to join the conference room thus this field is invalid.</li> <li>• Password must be at least 4 characters and different than conference extension number.</li> </ul>
<b>Enable Caller Menu</b>	If enabled, conference participant could press the * key to access the conference room menu. The default setting is "No".



<b>Record Conference</b>	<p>If enabled, the calls in this conference room will be recorded automatically in a .wav format file.</p> <p>All the recording files will be displayed and can be downloaded in the conference web page. The default setting is "No".</p>
<b>Quiet Mode</b>	<p>If enabled, if there are users joining or leaving the conference, voice prompt or notification tone will not be played. The default setting is "No".</p> <p><b>Note:</b> "Quiet Mode" and "Announce Callers" cannot be enabled at the same time.</p>
<b>Kick Warning Interval (minutes)</b>	<p>If there is only one participant in a conference room, a kick warning prompt will play at the configured interval. If no input from the participant is received after the prompt, he will be automatically kicked out of the conference. The valid range is 1-60 minutes.</p>
<b>Wait For Host</b>	<p>If enabled, the participants will not hear each other until the conference host joins the conference. The default setting is "No".</p> <p><b>Note:</b> If "Quiet Mode" is enabled, the voice prompt for "Wait For Host" will not be announced.</p>
<b>Allow User Invite</b>	<p>If enabled, users could press 0 to invite other users (with the users' permission) or press 1 to invite other users (without the user's permission) to join the conference. The default setting is "No".</p> <p><b>Note:</b> Conference host can always invite other users without enabling this option.</p>
<b>Announce Callers</b>	<p>If enabled, the caller will be announced to all conference participants when there the caller joins the conference. The default setting is "No".</p> <p><b>Notes:</b></p> <ul style="list-style-type: none"> <li>"Quiet Mode" and "Announce Callers" cannot be enabled at the same time.</li> <li>Conference participant names will be announced when joining/leaving the conference even when the conference is on hold.</li> </ul>
<b>Public Mode</b>	<p>If enabled, no authentication will be required when joining the conference call.</p> <p>The default setting is "Yes".</p>
<b>Play Hold Music</b>	<p>If enabled, the UCM6510 will play Hold music to the first participant in the conference until another user joins in. The default setting is "No".</p>
<b>Music On Hold</b>	<p>Select the music on hold playlist to be played in conference call. This option shows up if "Play Hold Music For First Caller" is enabled. Music On Hold playlist can be set up under Web GUI→<b>PBX Settings</b>→<b>Music On Hold</b>.</p>
<b>Custom Music On Hold</b>	<p>Select a custom Music On Hold</p>



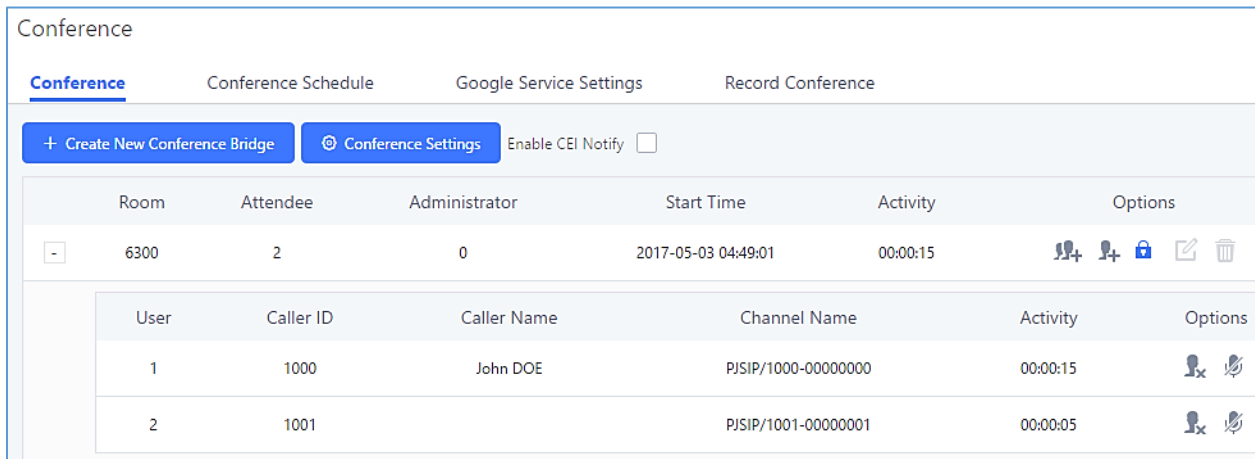
<b>Skip Authentication</b>	If enabled, the invitation from Web GUI for a conference room with password will skip the authentication for the invited users. The default setting is "No".
----------------------------	--

Conference Settings contains the following options:

**Table 72: Conference Settings**

<b>Enable Talk detection</b>	If enabled, the AMI will send the corresponding event when a user starts or ends talking.
<b>DSP Talking Threshold</b>	The time in milliseconds of sound above what the dsp has established as base line silence for a user before a user is considered to be talking. This value affects several operations and should not be changed unless the impact on call quality is fully understood, the default value is 128.
<b>DSP Silence Threshold</b>	The time in milliseconds of sound falling within the what the dsp has established as base line silence before a user is considered to be silent. This value affects several operations and should not be changed unless the impact on call quality is fully understood, the default value is 2500.
<b>Enable Neteq</b>	If enabled, conference audio quality may improve, but system performance will be lowered.

Users can check the talking Caller IDs in conference control page (UCM WebUI→**Call Features**→**Conference**). The image will move up and down when the user is talking.



The screenshot shows the 'Conference' page in the UCM WebUI. It includes navigation tabs for 'Conference', 'Conference Schedule', 'Google Service Settings', and 'Record Conference'. Below the tabs are buttons for '+ Create New Conference Bridge' and 'Conference Settings', along with an 'Enable CEI Notify' checkbox. The main content area displays a table of conference rooms and a detailed view of participants.

Room	Attendee	Administrator	Start Time	Activity	Options
6300	2	0	2017-05-03 04:49:01	00:00:15	[Icons]

User	Caller ID	Caller Name	Channel Name	Activity	Options
1	1000	John DOE	PJSIP/1000-00000000	00:00:15	[Icons]
2	1001		PJSIP/1001-00000001	00:00:05	[Icons]

**Figure 140: Conference**



## Conference Call Operations


### Join a Conference Call

Users could dial the conference room extension to join the conference. If password is required, enter the password to join the conference as a normal user, or enter the admin password to join the conference as a host.

### Invite Other Parties to Join Conference

When using the UCM6510 conference room, there are two ways to invite other parties to join the conference.

- **Invite from Web GUI**

For each conference room in UCM6510 Web GUI → **Call Features** → **Conference**, there is an icon  for option "Invite a participant". Click on it and enter the number of the party you would like to invite. Then click on "Add". A call will be sent to this number to invite it to the conference.

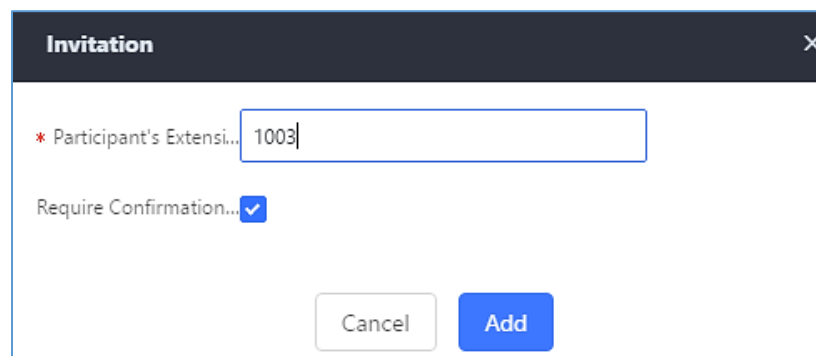


Figure 141: Conference Invitation From Web GUI


- **Invite by dialing 0 or 1 during conference call**

A conference participant can invite other parties to the conference by dialing during the conference call. Please make sure "Allow User Invite" is turned on for the conference room first. Enter 0 or 1 during the conference call. Follow the voice prompt to input the number of the party you would like to invite. A call will be sent to this number to join it into the conference.

If 0 is entered, once the invited party picks up the invitation call, the system will ask the party to accept or reject the invitation.

If 1 is entered, once the invited party picks up the call, they will automatically be brought into the conference.

---

 **Note:**

Conference administrator can always invite other parties from the phone during the call by entering 0 or 1.





---

## During The Conference

During the conference call, users can manage the conference from Web GUI or IVR.

- **Manage the conference call from Web GUI.**

Log in UCM6510 Web GUI during the conference call, the participants in each conference room will be listed.

1. Click on  to kick a participant from the conference.
2. Click on  to mute the participant.
3. Click on  to lock this conference room so that other users cannot join it anymore.
4. Click on  to invite other users into the conference room.

- **Manage the conference call from IVR.**

If "Enable Caller Menu" is enabled, conference participant can input \* to enter the IVR menu for the conference. Please see options listed in the table below.


**Table 73: Conference Caller IVR Menu**

Conference Administrator IVR Menu	
1	Mute/unmute yourself.
2	Lock/unlock the conference room.
3	Kick the last joined user from the conference.
4	Decrease the volume of the conference call.
6	Increase the volume of the conference call.
7	Decrease your volume.
9	Increase your volume.



<b>8</b>	More options: <ul style="list-style-type: none"> <li>• 1: List all users currently in the conference call.</li> <li>• 2: Kick all non-Administrator participants from the conference call.</li> <li>• 3: Mute/Unmute all non-Administrator participants from the conference call.</li> <li>• 4: Enable/disable conference call recording.</li> <li>• 8: Exit the caller menu and return to the conference.</li> </ul>
<b>Conference User IVR Menu</b>	
<b>1</b>	Mute/unmute yourself.
<b>4</b>	Decrease the volume of the conference call.
<b>6</b>	Increase the volume of the conference call.
<b>7</b>	Decrease your volume.
<b>9</b>	Increase your volume.
<b>8</b>	Exit the caller menu and return to the conference.

---

 **Note:** When there is participant in the conference, the conference room configuration cannot be modified.

---

## Google Service Settings Support

UCM6510 now supports Google OAuth 2.0 authentication. This feature is used for supporting UCM6510 conference scheduling system. Once OAuth 2.0 is enabled, UCM6510 conference system can access Google calendar to schedule or update conference.

Google Service Settings can be found under Web GUI → **Call Features** → **Conference** → **Google Service Settings**.

OAuth2.0 Authentication

\* OAuth2.0 Client ID:

\* OAuth2.0 Client Secret:

**Figure 142: Google Service Settings: OAuth2.0 Authentication**

If you already have OAuth2.0 project set up on **Google Developers** web page, please use your existing

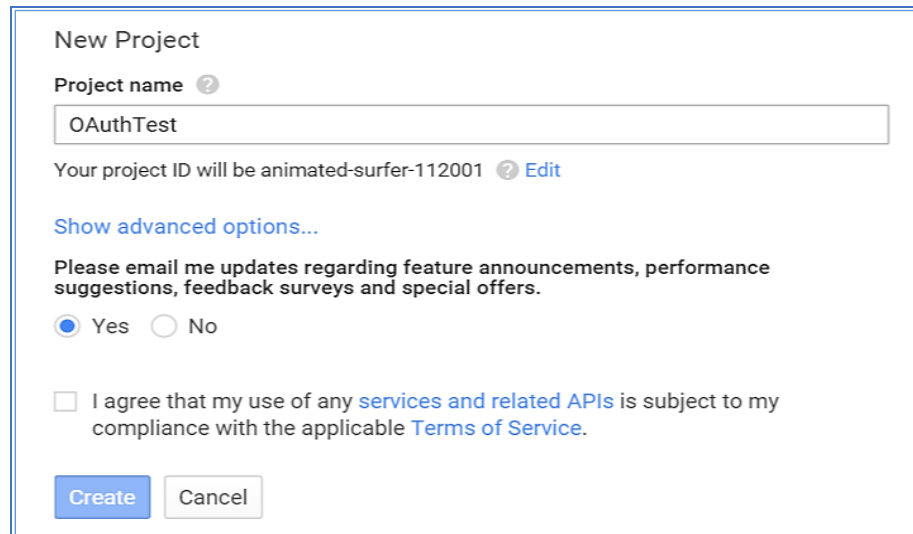




login credential for “OAuth2.0 Client ID” and “OAuth2.0 Client Secret” in the above figure for the UCM6510 to access Google Service.

If you do not have OAuth2.0 project set up yet, please following the steps below to create new project and obtain credentials:

1. Go to Google Developers page <https://console.developers.google.com/start> Create a New Project in Google Developers page.



**New Project**

Project name <sup>?</sup>

OAuthTest

Your project ID will be animated-surfer-112001 <sup>?</sup> [Edit](#)

[Show advanced options...](#)

Please email me updates regarding feature announcements, performance suggestions, feedback surveys and special offers.

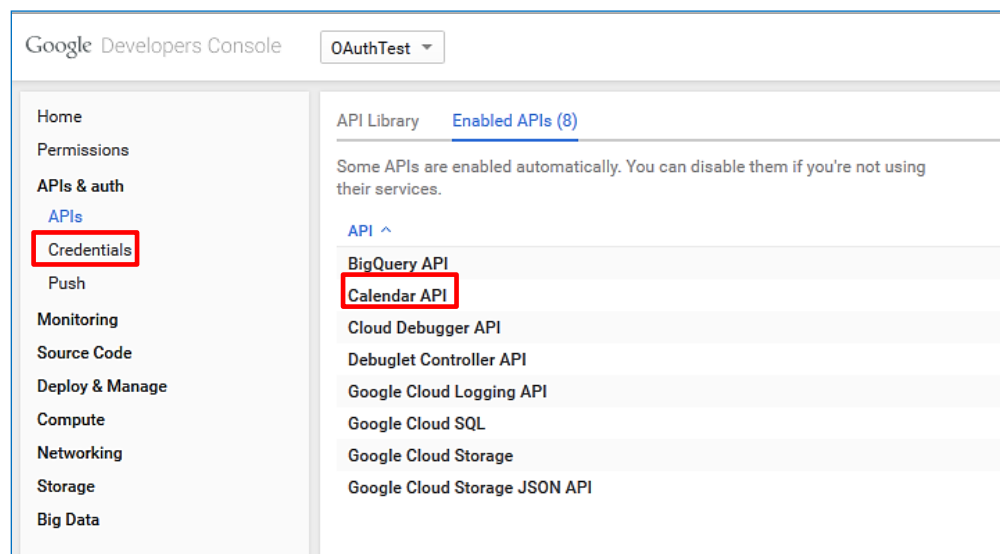
Yes  No

I agree that my use of any [services and related APIs](#) is subject to my compliance with the applicable [Terms of Service](#).

[Create](#) [Cancel](#)

**Figure 143: Google Service: New Project**

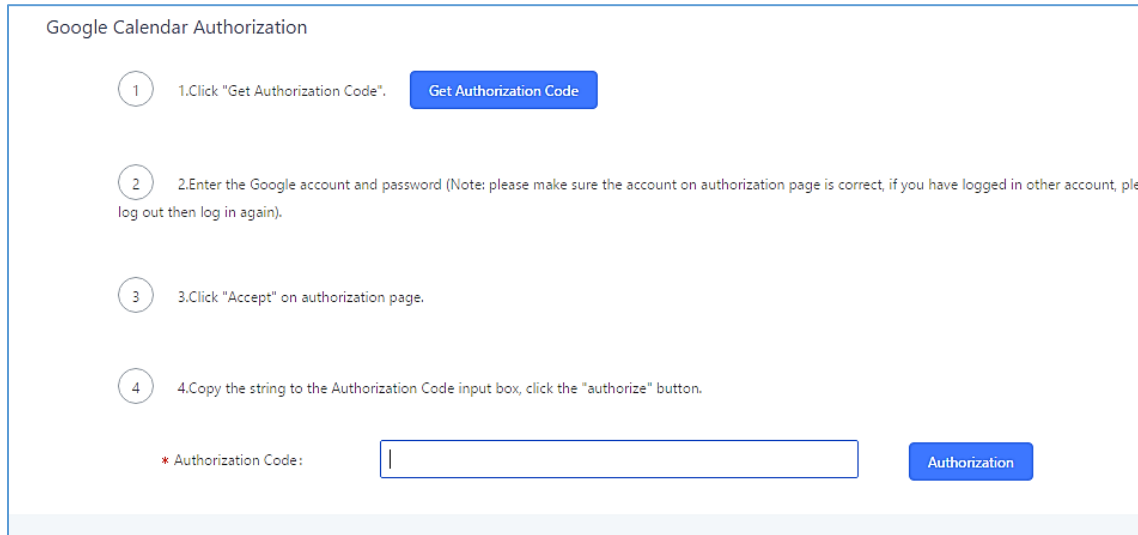
2. Enable Calendar API from API Library.
3. Click “Credentials” on the left drop down menu to create new OAuth2.0 login credentials.



**Figure 144: Google Service: Create new credential**



4. Use the newly created login credential to fill in “OAuth2.0 Client ID” and “OAuth2.0 Client Secret”.
5. Click “Get Authentication Code” to obtain authentication code from Google Service.



**Figure 145: Google Service: OAuth2.0 login**

6. Now UCM6510 is connected with Google Service.

## Conference Schedule

Conference Schedule can be found under UCM6510 Web GUI → **Call Features** → **Conference Schedule**. Users can create, edit, view and delete a Conference Schedule.

- Click on “Create New Conference Schedule” to add a new Conference Schedule.
- Click on the scheduled conference to edit or delete the event.

After the user configures UCM6510 with Google Service Settings [**Google Service Settings Support**] and enables Google Calendar for Conference Schedule, the conference schedule on the UCM6510 can be synchronized with Google Calendar for authorized Google account.

**Table 74: Conference Schedule Parameters**

Schedule Options	
<b>Conference Subject</b>	Configure the topic of the scheduled conference. Letters, digits, _ and - are allowed.
<b>Conference Room</b>	Select a conference room for this scheduled conference.
<b>Conference Password</b>	Conference login password.
<b>Host Password</b>	Host Password.



<b>Kick Time(m)</b>	<p>Set kick time before conference starts. When kick time is reached, a warning prompt will be played for all attendees in the conference room. After 5 minutes, this conference room will be cleared and locked for the scheduled conference to begin.</p> <p><b>Note:</b> Kick Time cannot be less than 6 minutes in order to clear the conference room.</p>
<b>Wait for Host</b>	<p>If enabled, conference participants will not hear each other until the host joins the conference.</p> <p>Note: If Quiet Mode is enabled, the voice prompt for this option will not be played.</p>
<b>Description</b>	The description of scheduled conference.
<b>Repeat</b>	Repeat interval of scheduled conference. By default, set to single event.
<b>Schedule Time</b>	<p>Configure the beginning date and duration of scheduled conference.</p> <p><b>Note:</b> Please pay attention to avoid time conflict on schedules in the same conference room.</p>
<b>Meeting Duration</b>	<p>Duration of the conference meeting.</p> <p><b>Note:</b> The maximum allowed meeting duration that can be set is 8 hour(s).</p>
<b>Enable Google Calendar</b>	<p>Select this option to synchronize scheduled conference with Google Calendar.</p> <p><b>Note:</b> Google Service Setting OAuth2.0 must be configured on the UCM6510. Please refer to section <b>[Google Service Settings Support]</b>.</p>
<b>Send email notification</b>	Sends Email notification to the extension.
<b>Conference Administrator</b>	<p>Select the administrator of scheduled conference from selected extensions.</p> <p><b>Note:</b> “Public Mode” must be disabled from Conference Room Options tab.</p>
<b>Local Extension</b>	Select available extensions from the list to attend scheduled conference.
<b>Remote Extension</b>	<p>Select available extensions from the remote peer PBX.</p> <p><b>Note:</b> “LDAP Sync” must be enabled on the UCM6510 in order to view remote extensions here.</p>
<b>Special Extension</b>	Add extensions that are not in the list (both local and remote list). If the user wishes to add the special extension, please make sure that the UCM's outbound routes will allow calling that special extension.
<b>Remote Conference</b>	Invite a remote conference.
<b>Conference Room Options</b>	
<b>Password</b>	Configure conference room password. Please note that if “Public Mode” is enabled, this option is automatically disabled.



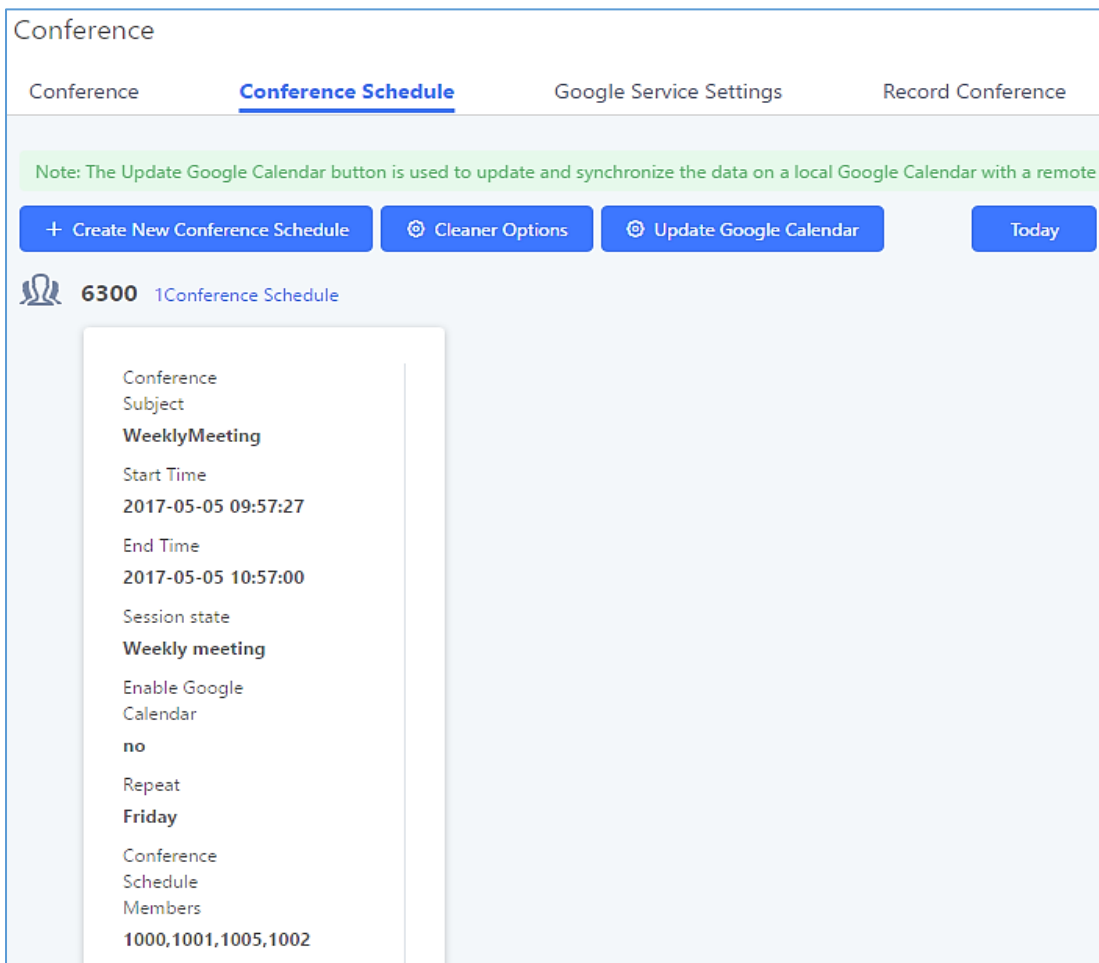
<b>Admin Password</b>	<p>Configure the password to join as conference administrator.</p> <p>Please note that if “Public Mode” is enabled, this option is automatically disabled.</p>
<b>Enable Caller Menu</b>	<p>If this option is enabled, conference participants will be able to access conference room menu by pressing the * key.</p>
<b>Record Conference</b>	<p>If this option is enabled, conference call will be recorded in .wav format. The recorded file can be found from <b>Conference</b> page.</p>
<b>Quiet Mode</b>	<p>If this option is enabled, the notification tone or voice prompt for joining or leaving the conference will not be played.</p> <p><b>Note:</b> Option “Quiet Mode” and option “Announce Caller” cannot be enabled at the same time.</p>
<b>Wait For Admin</b>	<p>If this option is enabled, the participants in the conference will not be able to hear each other until conference administrator joins the conference.</p> <p><b>Note:</b> If “Quiet Mode” is enabled, voice prompt for this option will not be played.</p>
<b>Enable User Invite</b>	<p>If this option is enabled, the user can:</p> <ul style="list-style-type: none"> <li>• Press ‘0’ to invite others to join the conference with invited party’s permission</li> <li>• Press ‘1’ to invite without invited party’s permission</li> <li>• Press ‘2’ to create a multi-conference room to another conference room</li> <li>• Press ‘3’ to drop all current multi-conference rooms</li> </ul> <p><b>Note:</b> Conference Administrator is always allowed to access this menu.</p>
<b>Announce Callers</b>	<p>If this option is enabled, when a participant joins the conference room, participant’s name will be announced to all members in the conference room.</p> <p><b>Note:</b> Option “Quiet Mode” and option “Announce Caller” cannot be enabled at the same time.</p>
<b>Public Mode</b>	<p>If this option is enabled, no authentication is required for entering the conference room.</p> <p><b>Note:</b> Please be aware of the potential security risks when turning on this option.</p>
<b>Play Hold Music</b>	<p>If this option is enabled, UCM6510 will play Hold Music while there is only one participant in the conference room or the conference is not yet started.</p>
<b>Skip Authentication When Inviting Users via Trunk from Web GUI</b>	<p>If this option is enabled, the invitation from Web GUI via a trunk with password will not require authentication.</p> <p><b>Note:</b> Please be aware of the potential security risks when turning on this option.</p>



## Cleaner Options

Cleaner Options	
<b>Enable Conference Schedules Cleaner</b>	If this option is enabled, conference schedules will be automatically cleaned as configured.
<b>Conference Schedules Clean Time</b>	Enter the clean time (in hours). The valid range is from 0 to 23.
<b>Clean Interval</b>	Enter the clean interval (in days). The valid range is from 1 to 30.

After configuring the scheduled conference, it will be shown under Conference Schedule page as below:



Conference

Conference Conference Schedule Google Service Settings Record Conference

Note: The Update Google Calendar button is used to update and synchronize the data on a local Google Calendar with a remote

+ Create New Conference Schedule Cleaner Options Update Google Calendar Today

6300 1Conference Schedule

Conference  
 Subject  
**WeeklyMeeting**  
 Start Time  
 2017-05-05 09:57:27  
 End Time  
 2017-05-05 10:57:00  
 Session state  
**Weekly meeting**  
 Enable Google Calendar  
**no**  
 Repeat  
**Friday**  
 Conference Schedule Members  
**1000,1001,1005,1002**

Figure 146: Conference Schedule

Once the conference room is scheduled, at the kick time, all users will be removed from conference room and no extension is allowed to join the conference room anymore. At the scheduled conference time, UCM6510 will send INVITE to the extensions that have been selected for conference.



 **Note:**

- Please make sure that outbound route is properly configured for remote extensions to join the conference.
- Once Kick Time is reached, Conference Schedule is locked and cannot be modified.

## Contact Group

Users can quickly invite multiple participants at once to a conference via conference contact groups. Up to 5 contact groups can be created. The maximum allowed number of contacts per group is based on the UCM model's conference participant limit: 25 for 6202/6204, 32 for 6208, 64 for 6510.

Each contact group must have a password configured, which will be required when inviting the specified contact group to a conference. Additionally, an audio file can be uploaded to each group to be used to announce the contact group name such as "Sales" or "Marketing". The default announcement for each group is "Conference Contact Group 1", "Conference Contact Group 2", etc.

**Create New Contact Group**

---

**Normal**

\* Name:

\* Password:

\* Prompt:  Upload Audio File

**Members ( 6 )**

Type:  Extensions  Self-defined

\* Number:



\* Name:

Add Cancel

NUMBER	NAME	TYPE	OPTIONS
1001	1001	Extensions	
1002	1002	Extensions	

**Figure 147: Contact Group Parameters**

## Contact Group Configurations

- Click on "Create New Contact Group" to add a new Contact Group.
- Click on  to edit the Contact Group.
- Click on  to delete the Contact Group.



**Table 75: Contact Group Parameters**

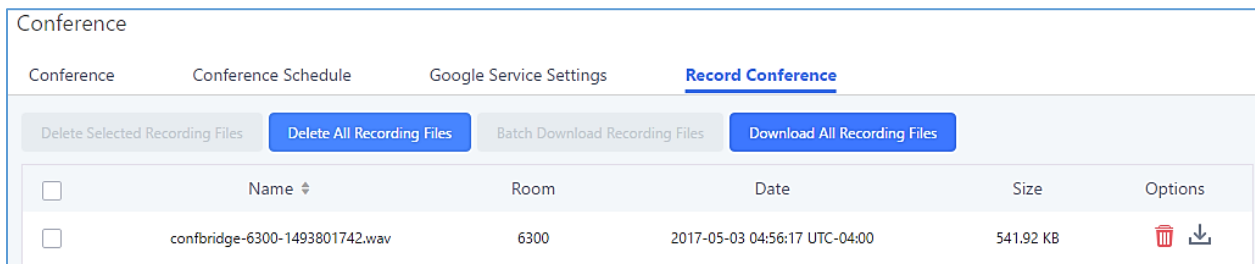
<b>Name</b>	Name associated to the contact group.
<b>Password</b>	Password required to invite the specified contact group to a conference.
<b>Prompt</b>	Audio file that can be uploaded to the group to announce the contact group name such as "Sales" or "Marketing". The <b>default</b> announcement for each group is "Conference Contact Group 1", "Conference Contact Group 2", etc.
<b>Members</b>	Contacts that needs to be added in each group.
<b>Type</b>	Type of the members to be added, it can be either <b>Extensions</b> or a <b>self-defined number</b> .



## Conference Recordings

The UCM6510 allows users to record the conference call and retrieve the recording from Web GUI → **Call Features** → **Conference**.

To record the conference call, when the conference room is in idle, enable "Record Conference" from the conference room configuration dialog. Save the setting and apply the change. When the conference call starts, the call will be automatically recorded in .wav format.

The recording files will be listed as below once available. Users could click on  to download the recording or click on  to delete the recording.



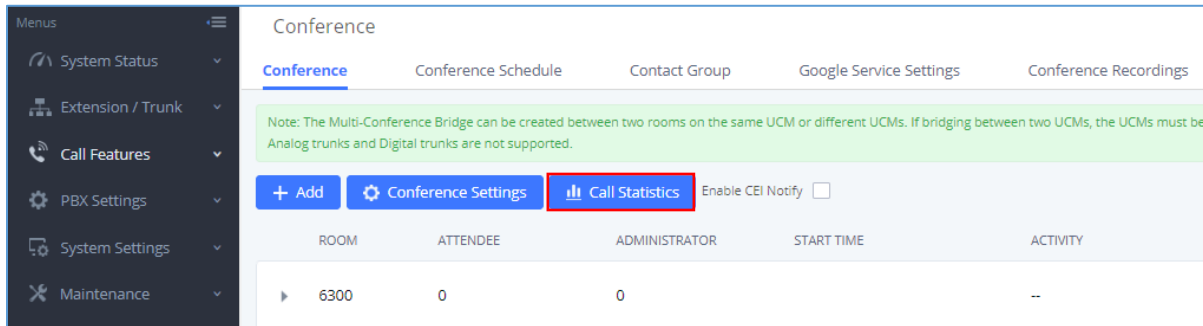
Conference					
Conference	Conference Schedule	Google Service Settings	<b>Record Conference</b>		
Delete Selected Recording Files		Delete All Recording Files		Batch Download Recording Files	
Download All Recording Files					
<input type="checkbox"/>	Name ↕	Room	Date	Size	Options
<input type="checkbox"/>	confbridge-6300-1493801742.wav	6300	2017-05-03 04:56:17 UTC-04:00	541.92 KB	 

**Figure 148: Conference Recording**



## Conference Call Statistics

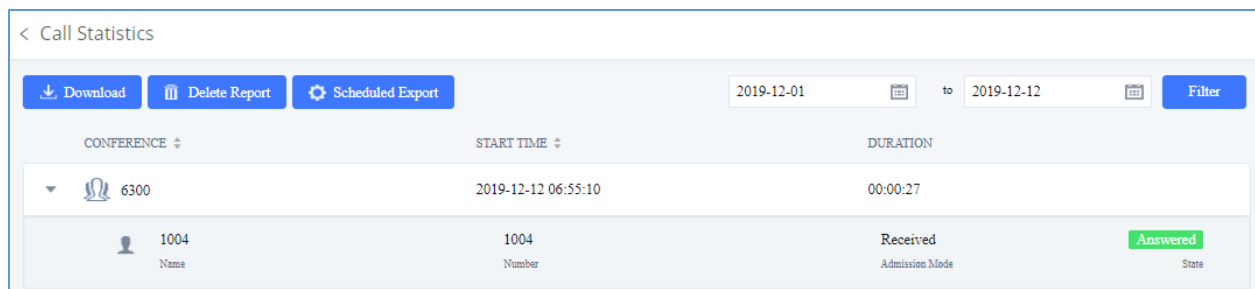
Conference reports will now be generated after every conference. These reports can be exported to a .CSV file for offline viewing. The conference report page can be accessed by clicking on the Call Statistics button on the main Conference page.



The screenshot shows the 'Conference' management page. On the left is a navigation menu with options like System Status, Extension / Trunk, Call Features, PBX Settings, System Settings, and Maintenance. The main content area has tabs for 'Conference', 'Conference Schedule', 'Contact Group', 'Google Service Settings', and 'Conference Recordings'. A green note states: 'Note: The Multi-Conference Bridge can be created between two rooms on the same UCM or different UCMs. If bridging between two UCMs, the UCMs must be Analog trunks and Digital trunks are not supported.' Below the note are buttons for '+ Add', 'Conference Settings', and 'Call Statistics' (highlighted in red). There is also an 'Enable CEI Notify' checkbox. A table below shows a single entry for room 6300 with 0 attendees and 0 administrators.

ROOM	ATTENDEE	ADMINISTRATOR	START TIME	ACTIVITY
▶ 6300	0	0		--

Figure 149: Conference Call Statistics



The screenshot shows the 'Call Statistics' report page. At the top, there are buttons for 'Download', 'Delete Report', and 'Scheduled Export'. A date range filter is set from 2019-12-01 to 2019-12-12. The table below has columns for CONFERENCE, START TIME, and DURATION. A single entry is shown for conference 6300 starting on 2019-12-12 at 06:55:10 with a duration of 00:00:27. Below this, a call entry is shown for contact number 1004, name 1004, admission mode 'Received', and state 'Answered'.

CONFERENCE	START TIME	DURATION
6300	2019-12-12 06:55:10	00:00:27

Contact Number	Name	Number	Admission Mode	State
1004	1004	1004	Received	Answered

Figure 150: Conference Report on Web

	A	B	C	D	E	F	G
1	Room	Start Time	Duration Time				
2	6301	11/7/2019 16:12	0:01:16				
3	Contact Number	Name	Way	Status	Contact Group Name		
4	1002	Conference invitatio	INVITE	FAILURE	Sales		
5	1005	Conference invitatio	INVITE	FAILURE	Sales		
6	1004	Conference invitatio	INVITE	FAILURE	Sales		
7	1003	Conference invitatio	INVITE	FAILURE	Sales		
8	1001	1001	CALLIN	ANSWER			

Figure 151: Conference Report on CSV







## VIDEO CONFERENCE

With the UCM you can easily create, schedule, manage, and join video conference calls, from your desktop or laptop computer. UCM Video conferencing uses WebRTC technology, so all the participants don't have to download and install any additional software or plugins. If upgrading from firmware that does not have this functionality, system administrators must first toggle on the Enable WebRTC option for extensions that want to use the UCM's WebRTC video conferencing feature. The video conference configurations can be accessed under Web GUI → **Call Features** → Video **Conference**. Here, users can create and manage video conference rooms and schedule video conferences.

### Video Conference Room Configurations

- Click on "Create New Conference Room" to add a new conference room.
- Click on  to edit the conference room.
- Click on  to delete the conference room.

**Table 76: Video Conference Room Configuration Parameters**

<b>Extension</b>	Configure the conference number for the users to dial into the conference. <b>Note:</b> Up to 64 characters.
<b>Password</b>	When configured, the users who would like to join the conference call must enter this password before accessing the conference room. <b>Note:</b> <ul style="list-style-type: none"> <li>• Only digits are allowed.</li> <li>• The password has to be at least 4 characters. All repetitive and sequential digits (e.g., 0000, 1111, 1234 and 2345) or common digits (e.g., 111222 and 321321) are not allowed.</li> </ul>



## Conference Settings

### Conference Settings

---

Video Conferencing:

\* Bind UDP Port:

Packet Loss Retransmission:

FEC:

Enable Talk Detection:

\* DSP Talking Threshold:

\* DSP Silence Threshold:

**Figure 152 : Video Conference Basic settings**

**Table 77: Video Conference Basic Settings**

Basic Settings	
<b>Video Conferencing</b>	This option should be enabled in order to activate the Video Conference feature.
<b>Bind UDP Port</b>	Configure the UDP port number for MCM. The standard UDP port for MCM is 5062.
<b>Packet Loss Retransmission</b>	Configure to enable Packet Loss Retransmission.
<b>FEC</b>	If enabled, the Forward Error Correction (FEC) will be activated. The default setting is "No".
<b>Enable Talk Detection</b>	If enabled, the AMI will send the corresponding event when a user starts or stops talking.
<b>DSP Talking Threshold</b>	The amount of time (ms) that sound exceeds what the DSP has established as the baseline for silence before a user is considered to be talking. This value affects several operations and should not be changed unless the impact on call quality is fully understood.
<b>DSP Silence Threshold</b>	The amount of time(ms) that sound falls within what the DSP has established as the baseline for silence before a user is considered be



silent. This value affects several operations and should not be changed unless the impact on call quality is fully understood.

## Conference Schedule

Conference Schedule can be found under UCM6510 **Web GUI** → **Call Features** → **Video Conference** → **Conference Schedule**. Users can create, edit, view and delete a Conference Schedule.

- Click on “Schedule New Conference” to add a new Conference Schedule.
- Click on the scheduled conference to edit or delete the event.

**Table 78: Video Conference Schedule Parameters**

Schedule Options	
<b>Conference Subject</b>	Configure the topic of the scheduled conference. Letters, digits, _ and - are allowed.
<b>Conference Room</b>	Select a conference room for this scheduled conference.
<b>Conference Password</b>	Configure conference room password. Please note that if “Public Mode” is enabled, this option is automatically disabled.
<b>Kick Time(m)</b>	Configure the time before the scheduled conference. When this time is reached, a warning prompt will be played, and all attendees currently in the scheduled conference room will be kicked after 5 mins. The conference room will be locked until the scheduled conference begins. Default value is 10 min.
<b>Schedule Time</b>	Configure the beginning date and duration of scheduled conference. <b>Note:</b> Please be mindful to avoid schedule conflicts for the same conference room.
<b>Host</b>	Set the admin of this scheduled conference from the following list of members.
<b>Members</b>	Select available extensions from the list to attend scheduled conference.
<b>Special Extension</b>	Add extensions that are not in the list (both local and remote list). If the user wishes to add the special extension, please make sure that the UCM's outbound routes will allow calling that special extension.
<b>Description</b>	Set a description of scheduled conference.
<b>Time Zone</b>	Configure the conference Time Zone.
<b>Local Extension</b>	Select the extensions from the list to attend this scheduled conference.
<b>Remote Extension</b>	The remote extension in the peer PBX connected to the local PBX via LDAP sync.



Once created, the Web GUI will display scheduled conference in Conference Schedule. Please see figure below:

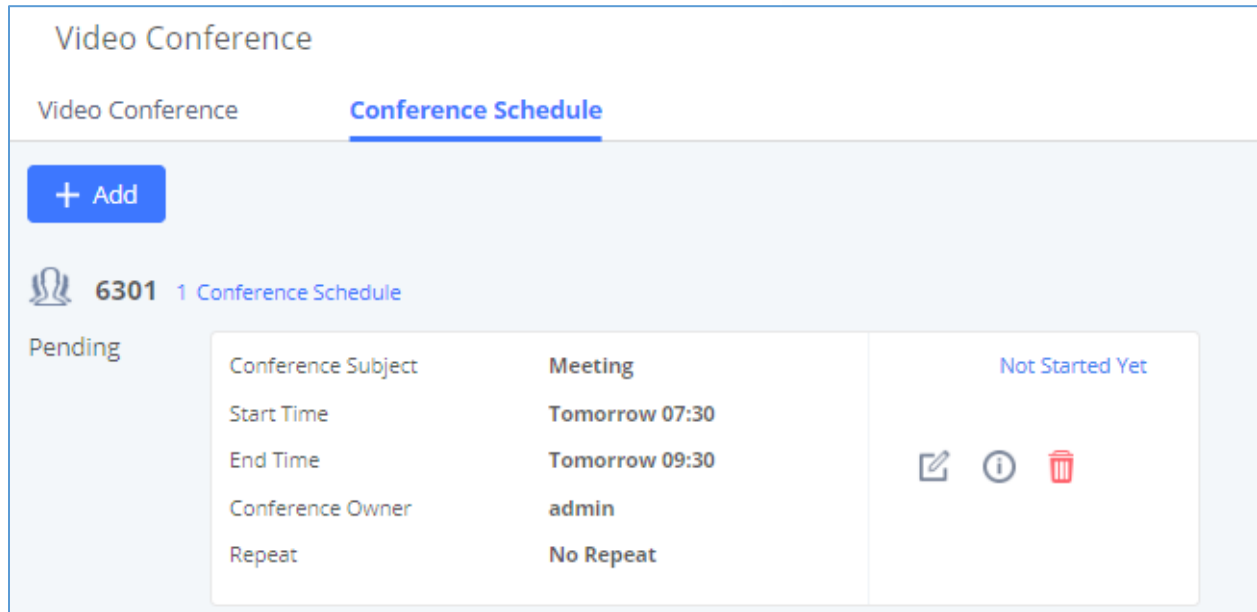


Figure 153: Video Conference Schedule

Once the conference room is scheduled, at the kick time, all users will be removed from conference room and no extension is allowed to join the conference room anymore. At the scheduled conference time, UCM6510 will send INVITE to the extensions that have been selected for conference.

---

 **Notes:**

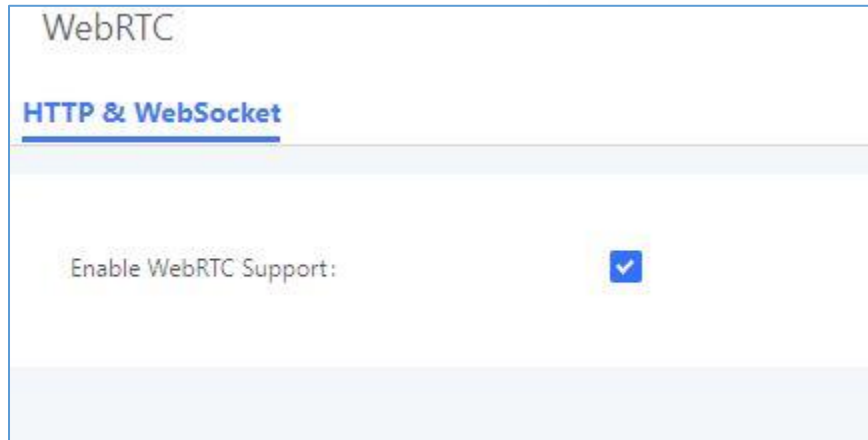
- Video conferencing can be resource-intensive and may cause performance issues with the UCM when used.
  - To ensure the best experience, please use Google Chrome (v67 or higher) or Mozilla Firefox (v60).
- 

## Wave WebRTC Video Calling & Conferencing

Web audio and video calls and conferencing can now be achieved through the UCM's new WebRTC page. To get started with this new feature, please make sure to:

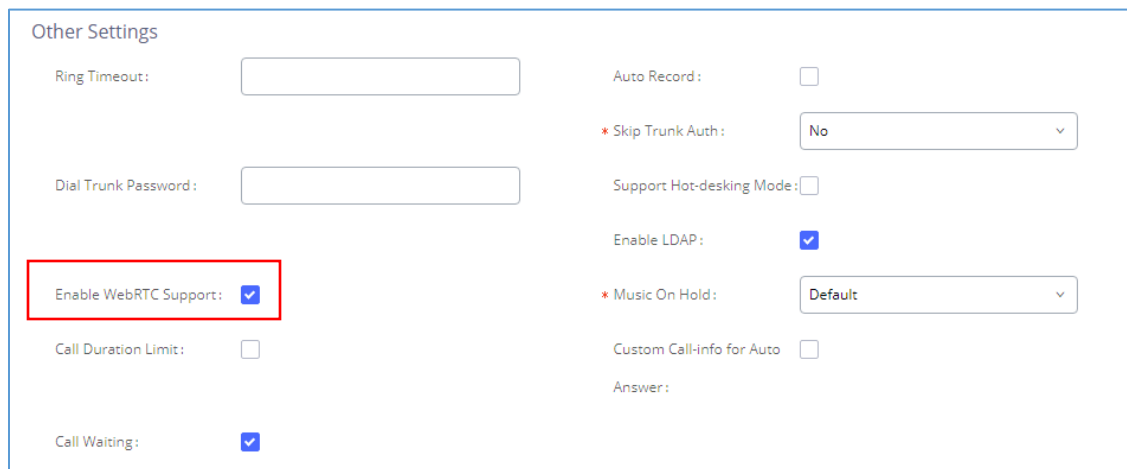
1. Navigate to **Value-Added Features** → **WebRTC** and enable WebRTC support.





**Figure 154 : Enabling WebRTC feature**

2. Enable the WebRTC on the extensions that would use this feature under **Extension / Trunk → Extensions**.

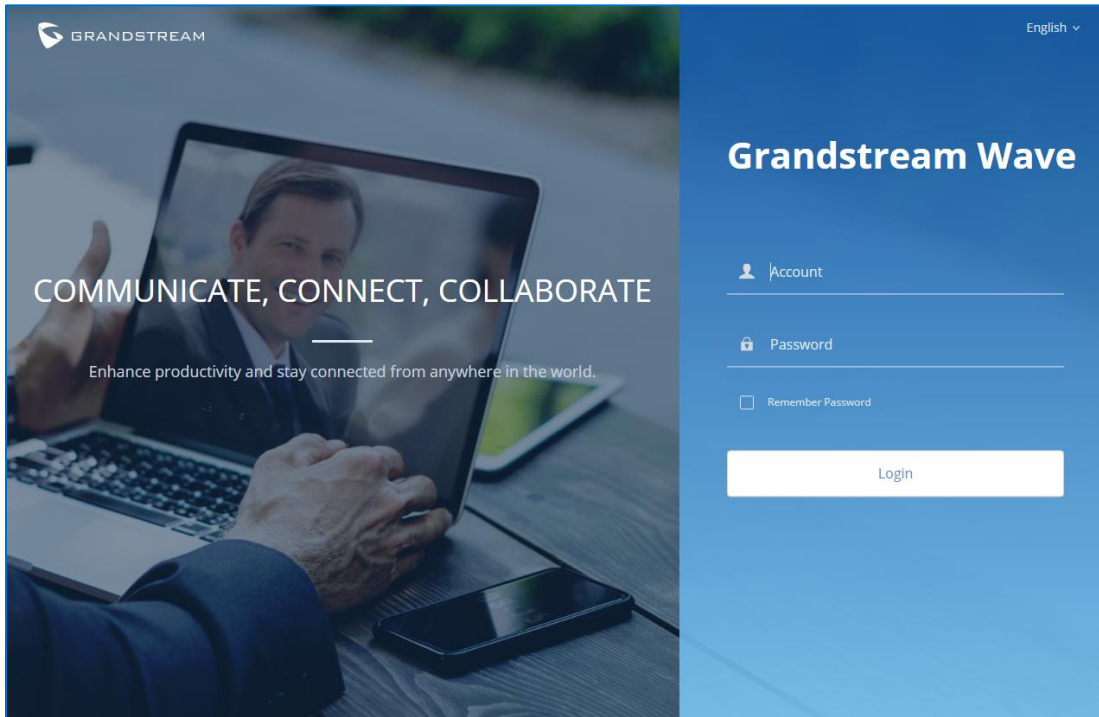


**Figure 155 : Enabling WebRTC on extensions**

The UCM offers the possibility to log in to an extension via Grandstream Wave Portal using user portal password in addition to SIP registration password, where it offers a sleek interface to host conferences, receive email reminders for scheduled conferences, manage contacts, initiate calls, call transfer, chat functionality and more.

Access the page by adding “/gswave” after the UCM’s server address and port. (e.g. <https://my.ucm.com:8089/gswave>).





**Figure 156: Grandstream Wave Interface**

**Note:** Starting with 1.0.19.27, the registration limit was increased to 500 for UCM6510. The limit is the same regardless of whether the user is making voice calls or video calls

For more details about the WebRTC feature, please refer to the following guide:

[http://www.grandstream.com/sites/default/files/Resources/wave\\_webrtc\\_guide.pdf](http://www.grandstream.com/sites/default/files/Resources/wave_webrtc_guide.pdf)

## IPVIDEOTALK MEETINGS

UCM extensions can now dial into IPVT (IPVideoTalk) meetings by creating a peer trunk to an IPVT server. However, users must make sure that the IPVT server they are peering to also has a peer trunk to their UCM configured. This setting can be found in Admin Center → SIP Trunk Configuration.

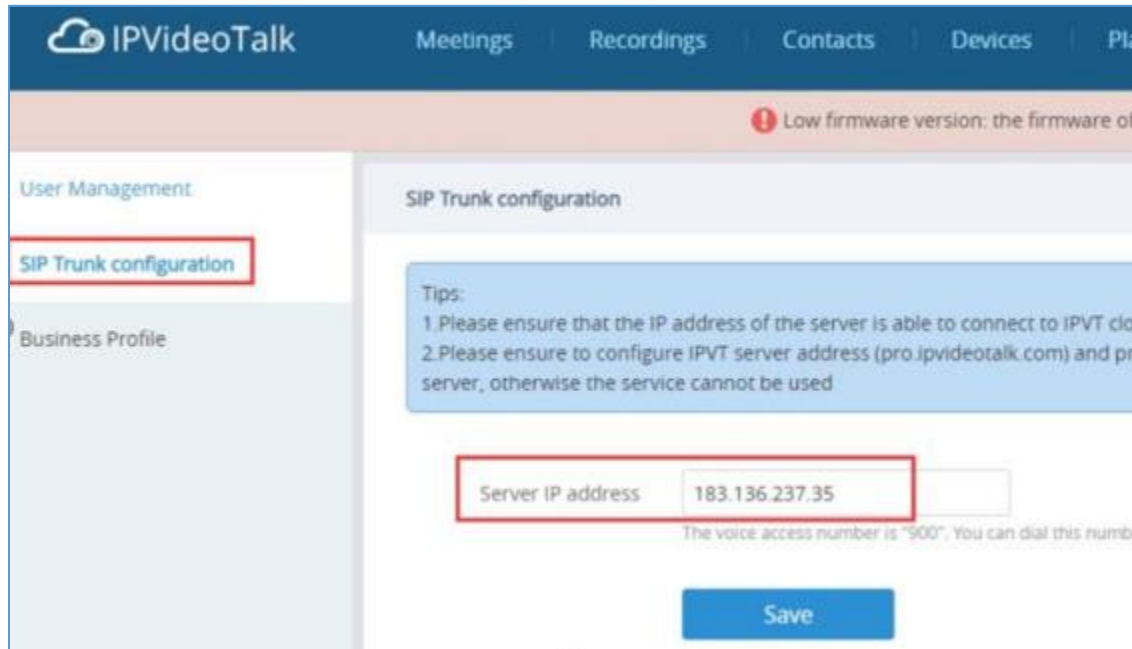


Figure 157: IPVT SIP Trunk page

Next, users must create a peer trunk on the UCM to the IPVT server. Enter one of the following addresses based on the desired connection protocol:

- TCP: pro.ipvideotalk.com:20000
- TLS: pro.ipvideotalk.com:20001

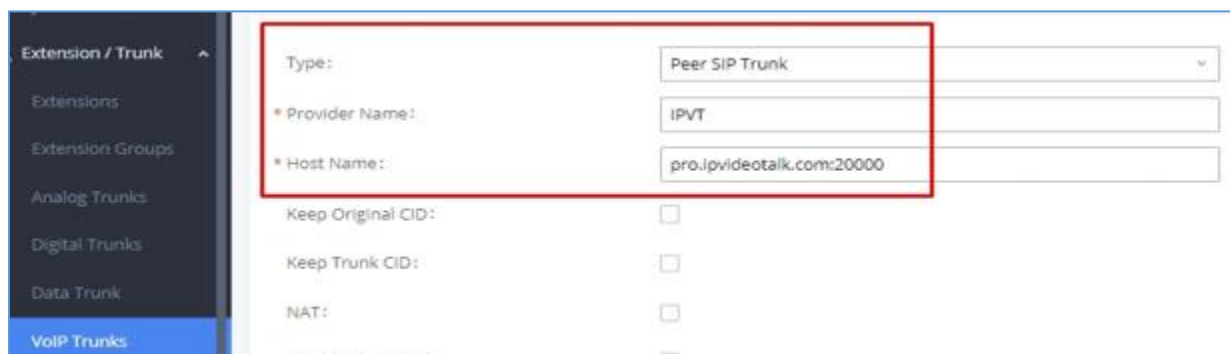
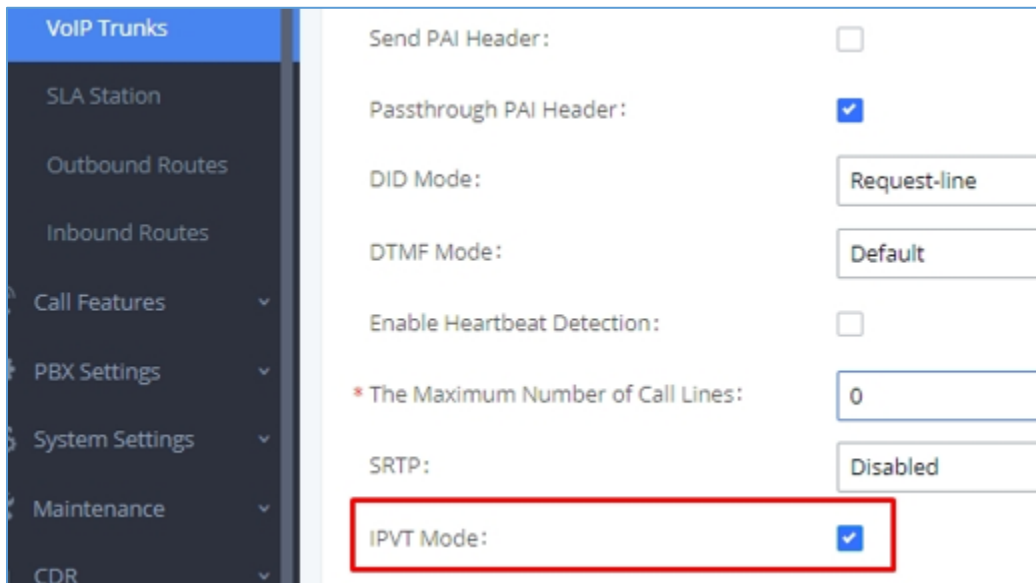


Figure 158 - Peer Trunk to IPVT

Make sure that the *Transport* field is either “TCP” or “TLS”. Save and apply changes to create the trunk.

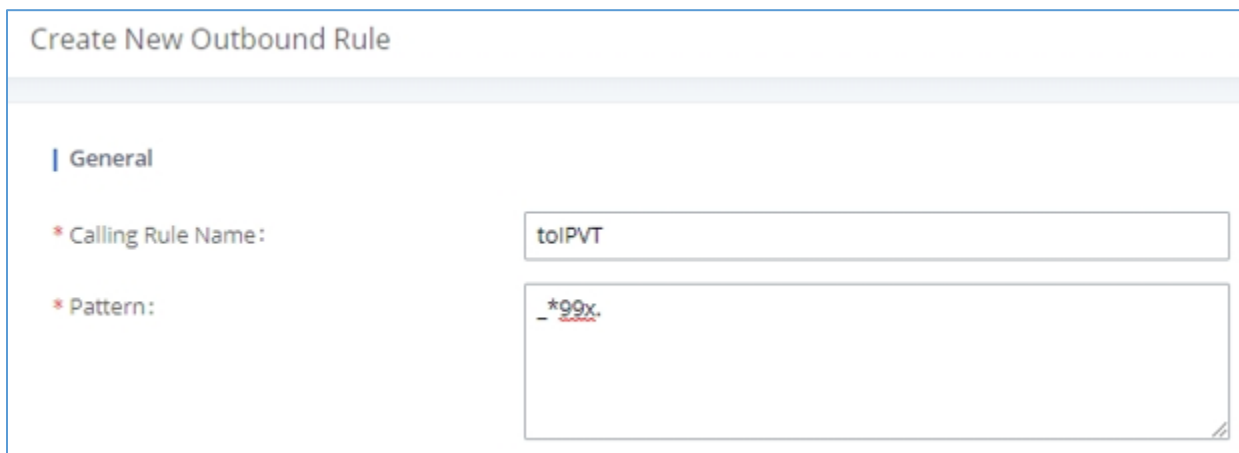


Next, edit the newly created trunk and click on the *Advanced Settings* tab. Make sure the *IPVT Mode* option is checked. Otherwise, you may experience audio issues when dialing into IPVT.



**Figure 159 - IPVT Mode**

Finally, create an outbound route for this trunk. This route will be used to dial IPVT meeting IDs. Due to IPVT meeting IDs having a random assortment of numbers, it is recommended to use a unique code to precede the meeting ID so that UCM can direct calls to the IPVT trunk without fail (e.g., \*99). In the below image, “x.” would be the meeting ID.



**Figure 160 - IPVT Outbound Pattern**

However, if a unique code is used, users must also configure the *Strip* field to remove the unique code from the meeting ID before the call is sent to IPVT.



| Main Trunk

\* Trunk:

Strip:

Prepend:

**Figure 161 - IPVT Outbound Strip**

In this example, the *Strip* field has “3” configured to remove the example unique code \*99 from the dialed number before the call is routed out to the IPVT server. Once this outbound route has been created, users can now use a UCM extension to dial IPVT meeting rooms.

Note: An IPVT account can have only 1 SIP trunk peered to it.





## IVR

### Configure IVR

IVR configurations can be accessed under the UCM6510 Web GUI → **Call Features** → **IVR**. Users could create, edit, view and delete an IVR.

**Note:** UCM6510 now supports 500 IVR entry.

- Click on "Create New IVR" to add a new IVR.
- Click on  to edit the IVR configuration.
- Click on  to delete the IVR.

Create New IVR

Basic Settings    Key Pressing Events

---

\* Name:

\* Extension:

Dial Trunk:

Dial Other Extensions:  All  Extension  Conference  Video Conference  
 Call Queue  Ring Group  Paging/Intercom Groups  
 Voicemail Groups  Fax Extension  Dial By Name


\* IVR Black/Whitelist:

Replace Display Name:

Return to IVR Menu:

Alert-info:

\* Prompt:

[Add Prompt](#) 

\* Digit Timeout:

\* Response Timeout:

\* Response Timeout Prompt:

\* Invalid Input Prompt:

\* Response Timeout Prompt:

Repeats:

\* Invalid Input Prompt Repeats:

Language:

Figure 162: Create New IVR



**Table 79: IVR Configuration Parameters**

Basic Settings	
<b>Name</b>	Configure the name of the IVR. Letters, digits, _ and - are allowed.
<b>Extension</b>	Enter the extension number for users to access the IVR.
<b>Dial other Extensions</b>	If enabled, the caller is allowed to dial extensions other than the ones explicitly defined.
<b>DID Destination</b>	<p>This option shows up only when "By DID" is selected. This controls the destination that can be reached by the external caller via the inbound route. The DID destination are:</p> <ul style="list-style-type: none"> <li>• Extension</li> <li>• Conference</li> <li>• Call Queue</li> <li>• Ring Group</li> <li>• Paging/Intercom Groups</li> <li>• Voicemail Groups</li> <li>• Fax Extension</li> <li>• Dial By Name</li> <li>• All</li> </ul>
<b>Dial Trunk</b>	If enabled, all callers to the IVR is allowed to use trunk. The permission must be configured for the users to use the trunk first. The default setting is "No".
<b>Permission</b>	Assign permission level for outbound calls if "Dial Trunk" is enabled. The available permissions are "Internal", "Local", "National" and "International" from the lowest level to the highest level. The default setting is "Internal". If the user tries to dial outbound calls after dialing into the IVR, the UCM6510 will compared the IVR's permission level with the outbound route's privilege level. If the IVR's permission level is higher than (or equal to) the outbound route's privilege level, the call will be allowed to go through.
<b>Replace Caller ID</b>	If enabled, the UCM will replace the caller display name with the IVR name the caller know whether the call is incoming from a direct extension or an IVR.
<b>Alert-Info</b>	When present in an INVITE request, the alert-Info header field specifies and alternative ring tone to the UAS.
<b>Return to IVR Menu</b>	If enabled and if a call to an extension fails, the caller will be redirected to the IVR menu.
<b>Welcome Prompt</b>	Select an audio file to play as the welcome prompt for the IVR. Click on "Prompt" to add additional audio file under Web GUI→ <b>PBX Settings</b> → <b>Voice Prompt</b> → <b>Custom Prompt</b> .



	<b>Note:</b> Up to 5 welcome prompts can be used..
<b>Digit Timeout</b>	Configure the timeout between digit entries. After the user enters a digit, the user needs to enter the next digit within the timeout. If no digit is detected within the timeout, the UCM6510 will consider the entries complete. The default timeout is 3 seconds.
<b>Response Timeout</b>	After playing the prompts in the IVR, the UCM6510 will wait for the DTMF entry within the timeout (in seconds). If no DTMF entry is detected within the timeout, a timeout prompt will be played. The default setting is 10 seconds.
<b>Response Timeout Prompt</b>	Select the prompt message to be played when timeout occurs.
<b>Invalid Prompt</b>	Select the prompt message to be played when an invalid extension is pressed.
<b>Response Timeout Prompt Repeats</b>	Configure the number of times to repeat the prompt if no DTMF input is detected. When the loop ends, it will go to the timeout destination if configured, or hang up. The default setting is 3.
<b>Invalid Input Prompt Repeats</b>	Configure the number of times to repeat the prompt if the DTMF input is invalid. When the loop ends, it will go to the invalid destination if configured, or hang up. The default setting is 3.
<b>Language</b>	Select the voice prompt language to be used for this IVR. The default setting is "Default" which is the selected voice prompt language under Web GUI→ <b>PBX Settings</b> → <b>Voice Prompt</b> → <b>Language Settings</b> . The dropdown list shows all the current available voice prompt languages on the UCM6510. To add more languages in the list, please download voice prompt package by selecting "Check Prompt List" under Web GUI→ <b>PBX Settings</b> → <b>Voice Prompt</b> → <b>Language Settings</b> .

### Key Pressing Events

<b>Key Press Event:</b>	Select the event for each key pressing for 0-9, *, Timeout and Invalid. The event options are:
Press 0	<ul style="list-style-type: none"> <li>• Extension</li> <li>• Voicemail</li> <li>• Conference Rooms</li> <li>• Voicemail Group</li> <li>• IVR</li> <li>• Ring Group</li> <li>• Queues</li> <li>• Page Group</li> <li>• Fax</li> <li>• Custom Prompt</li> <li>• Hangup</li> </ul>
Press 1	
Press 2	
Press 3	
Press 4	
Press 5	
Press 6	
Press 7	
Press 8	
Press 9	
Press *	
Timeout	



Invalid

- DISA
- Dial By Name
- External Number
- Callback
- Announcement

Edit IVR: OfficeOpen

Basic Settings Key Pressing Events

Press 0:	Extension ▾	2000 ▾
Press 1:	IVR ▾	Sales ▾
Press 2:	IVR ▾	Support ▾
Press 3:	Select an Op... ▾	
Press 4:	Select an Op... ▾	
Press 5:	Select an Op... ▾	
Press 6:	Select an Op... ▾	
Press 7:	Select an Op... ▾	
Press 8:	Select an Op... ▾	
Press 9:	Select an Op... ▾	
Press *:	Select an Op... ▾	
Timeout:	Custom Pro... ▾	goodbye ▾
Invalid:	Custom Pro... ▾	goodbye ▾

**Figure 163: Key Pressing Events**

## IVR Black/Whitelist

In some scenarios, the IPPBX administrator needs to restrict the extensions that can be reached from IVR. For example, the company CEO and directors prefer only receiving calls transferred by the secretary, some special extensions are used on IP surveillance end points which shouldn't be reached from external calls via IVR for privacy reason. UCM has now added blacklist and whitelist in IVR settings for users to manage this.

**Note:** up to 500 extensions are allowed on the black/white list.

To use this feature, log in UCM Web GUI and navigate to **Call Features**→**IVR**→**Create/Edit IVR: IVR**



#### Black/White List.

- If the user selects “Blacklist Enable” and adds extension in the list, the extensions in the list will not be allowed to be reached via IVR.
- If the user selects “Whitelist Enable” and adds extension in the list, only the extensions in the list can be allowed to be reached via IVR.



### Create New IVR

\* Name:

\* Extension:

Dial Trunk:

\* Permission:

Dial Other Extensions:

- Extension  Conference  Call Queue
- Ring Group  Paging/Intercom Groups
- Voicemail Groups  Fax Extension
- Dial By Name
- All

\* IVR Black/Whitelist:

Internal Black/Whitelist:

Available	Selected
<input type="checkbox"/> 1 <input type="checkbox"/> 1005 "Marcel LAST"	<input type="checkbox"/> 3 <input type="checkbox"/> 1001 <input type="checkbox"/> 1002 <input type="checkbox"/> 1000 "John DOE"

External Blacklist/Whitelist:

Replace Display Name:

Alert-info:

\* Prompt:  Prompt

\* Digit Timeout:

\* Response Timeout:

\* Response Timeout Promp...:  Prompt

\* Invalid Prompt:  Prompt

\* Response Timeout Repeat...:

\* Invalid Repeat Loops:

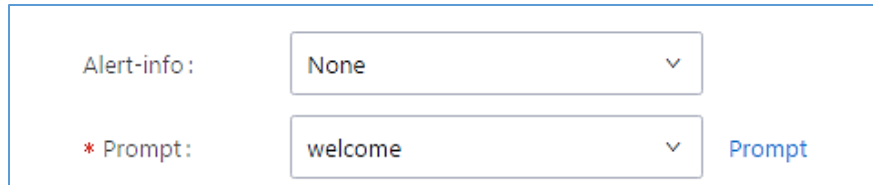
Language:

**Figure 164: Black/White List**



## Create Custom Prompt

To record new IVR prompt or upload IVR prompt to be used in IVR, click on "Prompt" next to the "Welcome Prompt" option and the users will be redirected to IVR Prompt page. Or users could go to Web GUI→**PBX Settings**→**Voice Prompt**→**Custom Prompt** page directly.



Alert-info:	None	▼
* Prompt:	welcome	▼

Prompt

Figure 165: Click on Prompt to Create IVR Prompt

Once the IVR prompt file is successfully added to the UCM6510, it will be added into the prompt list options for users to select in different IVR scenarios.



## VOICE PROMPT

The UCM6510 supports multiple languages in Web GUI as well as system voice prompt. The following languages are currently supported in system voice prompt:

English (United States), Arabic, Chinese, Dutch, English (United Kingdom), French, German, Greek, Hebrew, Italian, Polish, Portuguese, Russian, Spanish, Catalan, Czech, Swedish and Turkish.

English (United States) and Chinese voice prompts are built in with the UCM6510 already. The other languages provided by Grandstream can be downloaded and installed from the UCM6510 Web GUI directly. Additionally, users could customize their own voice prompts, package them and upload to the UCM6510.

Language settings for voice prompt can be accessed under Web GUI → **PBX Settings** → **Voice Prompt** → **Language Settings**. Additionally, UCM6510 allows to customize specific prompt instead of full language package, and it provides ability to upload greeting files for extensions.

### Language Settings

#### Download and Install Voice Prompt Package

To download and install voice prompt package in different languages from UCM6510 Web GUI, click on "Add Voice Prompt Package" button.

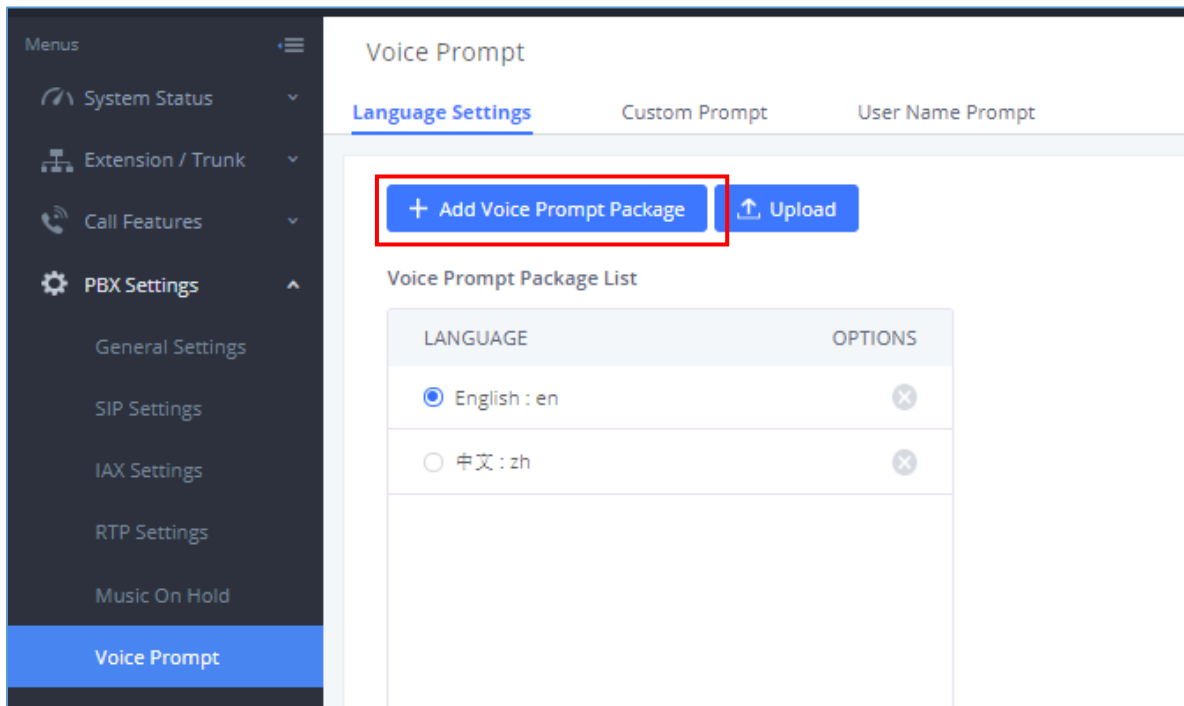


Figure 166: Language Settings for Voice Prompt




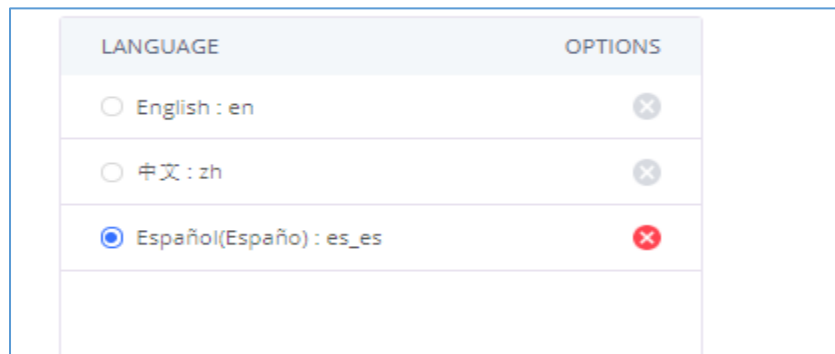
A new dialog window of voice prompt package list will be displayed. Users can see the version number (latest version available V.S. current installed version), package size and options to upgrade or download the language.



VOICE PROMPT PACKAGE LIST	VERSION (REMOTE / LOCAL)	SIZE	OPTIONS
British English	1.9/-	4.2M	↓
Deutsch	1.8/-	4.2M	↓
English	1.11/1.11	6.0M	↑
Español	1.10/-	4.4M	↓
Español(Català)	1.8/-	3.1M	↓
Español(Español)	1.8/-	4.2M	↓
Ελληνικά	1.8/-	4.4M	↓
Français	1.8/-	4.1M	↓
Italiano	1.8/-	4.0M	↓

**Figure 167: Voice Prompt Package List**

Click on  to download the language to the UCM6510. The installation will be automatically started once the downloading is finished.



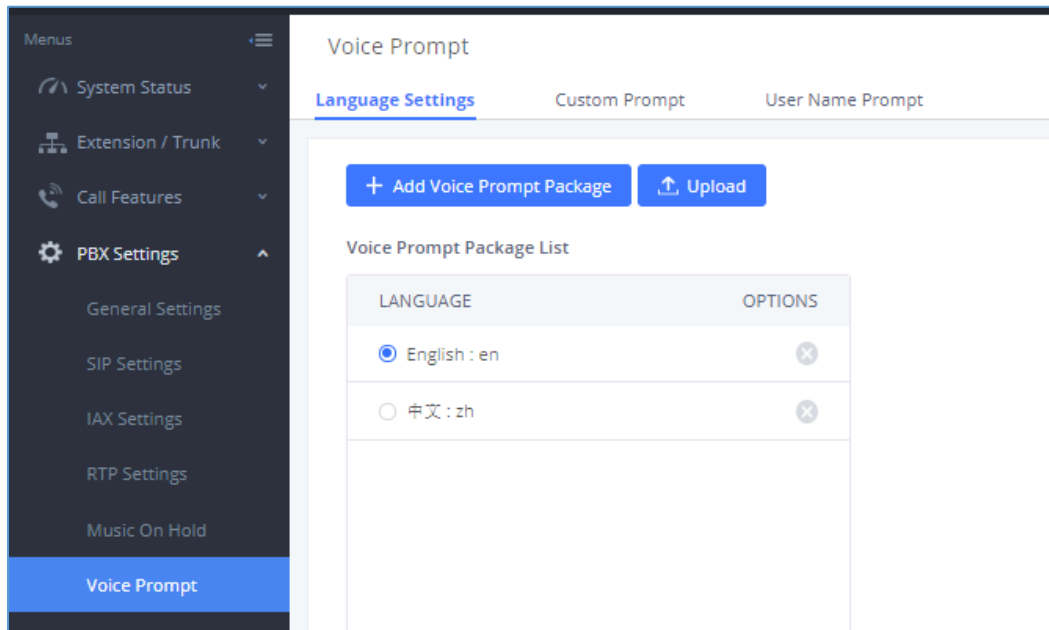
LANGUAGE	OPTIONS
<input type="radio"/> English : en	⊗
<input type="radio"/> 中文 : zh	⊗
<input checked="" type="radio"/> Español(Español) : es_es	⊗

**Figure 168: New Voice Prompt Language Added**

A new language option will be displayed after successfully installed. Users then could select it to apply in the UCM6510 system voice prompt or delete it from the UCM6510.

## Upload Language Package

On the UCM6510, if the user needs to replace some specific customized prompt, the user can upload a single specific customized prompt from Web GUI→**PBX Settings**→**Voice Prompt**→**Language Settings** instead of the entire language pack.



**Figure 169: Upload Voice Prompts Package**

The package file should follow below requirements:

- Each file uploaded must be under 50MB.
- Package structure:

```
[Package]
├ [voice prompt dir]
│ └ [... dir]
│   └ [... files]
└ info.txt (containing the language name for display, in UTF8)
```

- Language dir name format:
- Custom dir name format: language\_xxx;  
 For example: If there is a Chinese custom directory named zh\_xxx, the custom voice prompt in zh\_xxx would be used first, then the Chinese voice prompt zh, then use the default language prompt (en); If not named the format as above, then the custom prompt will be used first, then use the default language prompt (en).

For more details, please refer to:

[http://www.grandstream.com/sites/default/files/Resources/ucm\\_voiceprompt\\_customization\\_guide.zip](http://www.grandstream.com/sites/default/files/Resources/ucm_voiceprompt_customization_guide.zip)



## Custom Prompt

### Record New Custom Prompt

In the UCM6510 Web GUI→**PBX Settings**→**Voice Prompt**→**Custom Prompt** page, click on "Record New IVR Prompt" and follow the steps below to record new IVR prompt.

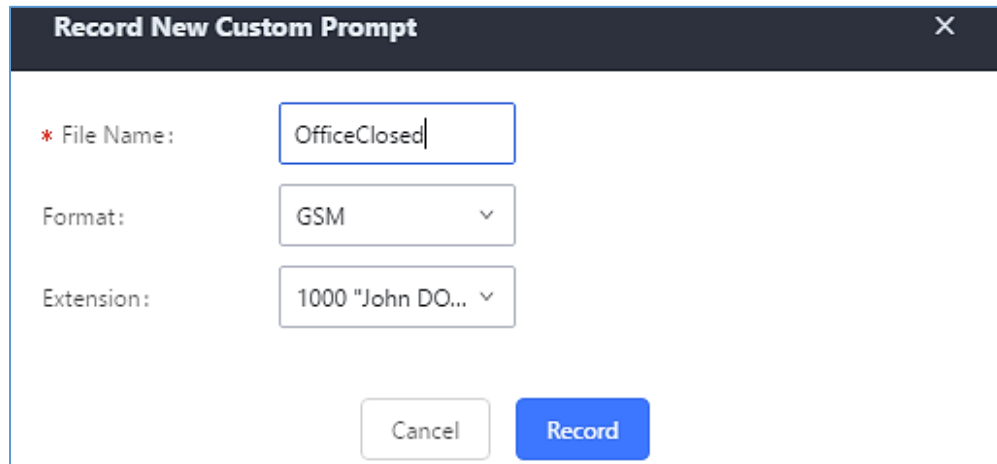


Figure 170: Record New IVR Prompt

1. Specify the IVR file name.
2. Select the format (GSM or WAV) for the IVR prompt file to be recorded.
3. Select the extension to receive the call from the UCM6510 to record the IVR prompt.
4. Click the "Record" button. A request will be sent to the UCM6510. The UCM6510 will then call the extension for recording the IVR prompt from the phone.
5. Pick up the call from the extension and start the recording following the voice prompt.
6. The recorded file will be listed in the IVR Prompt web page. Users could select to re-record, play or delete the recording.

### Upload Custom Prompt

If the user has a pre-recorded IVR prompt file, click on "Upload IVR Prompt" in Web GUI→**PBX Settings**→**Voice Prompt**→**Custom Prompt** page to upload the file to the UCM6510. The following are required for the IVR prompt file to be successfully uploaded and used by the UCM6510:

- PCM encoded.
- 16 bits.
- 8000Hz mono.
- In .mp3 or .wav format; or raw/ulaw/alaw/gsm file with .ulaw or .alaw suffix.
- File size under 5M.



- Filename should not exceed 100 characters.

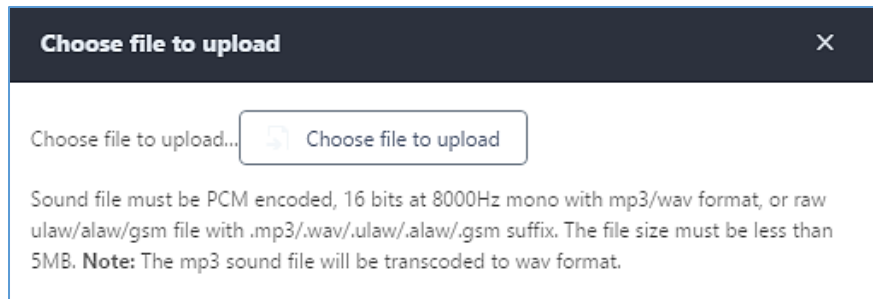


Figure 171: Upload IVR Prompt

Click on “choose file to upload” to select audio file from local PC and to start uploading. Once uploaded, the file will appear in the IVR Prompt web page.

## Download All Custom Prompt

On the UCM6510, the users can download all custom prompts from UCM Web GUI to local PC. To download all custom prompt, log in UCM Web GUI and navigate to **PBX Settings**→**Voice Prompt**→**Custom Prompt** and click on [Download All Custom Prompt](#). The following window will pop up in order to set a name for the downloaded file.

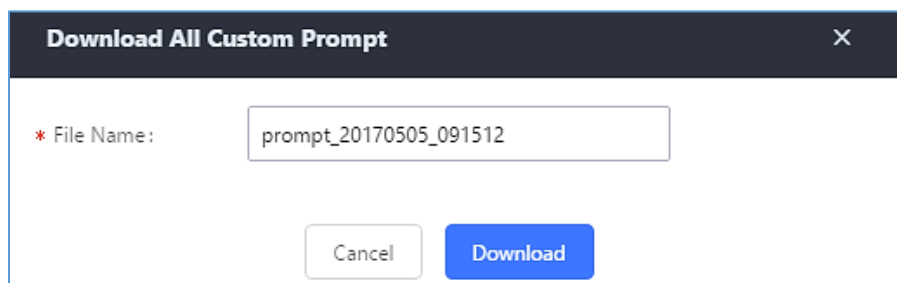


Figure 172: Download All Custom Prompt

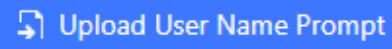

**Note:** The downloaded file will have a .tar extension.

## Username Prompt Customization

There are two ways to customize/set new username prompt:

### Upload Username Prompt File from Web GUI

1. First, Users should have a pre-recorded file respecting the following format:
  - PCM encoded / 16 bits / 8000Hz mono.

- In “.GSM” or “.WAV” format.
  - File size under 5M.
  - Filename must be set as the extension number with 18 characters max. For example, the recorded file name 1000.wav will be used for extension 1000.
2. Go under web GUI **PBX Settings** → **Voice Prompt** → **Username Prompt** and click on  button.
  3. Select the recorded file to upload it and press Save and Apply Settings.
- To delete username prompts, either click on the  button to delete a single file or select multiple files and click on Delete button to delete selected prompts at once.

### Record Username via Voicemail Menu

The second option to record username is using voicemail menu, please follow below steps:

- Dial \*98 to access the voicemail
- After entering the desired extension and voicemail password, dial “0” to enter the recordings menu and then “3” to record a name.

Another option is that each user can record their own name by following below steps:

- The user dials \*97 to access his/her voicemail
- After entering the voicemail password, the user can press “0” to enter the recordings menu and then “3” to record his name.



# VOICEMAIL

## Configure Voicemail

If the voicemail is enabled for UCM6510 extensions, the configurations of the voicemail can be globally set up and managed under Web GUI→**Call Features**→**Voicemail**.

Voice Mail
Voicemail Groups

Voicemail Email Settings
User Name Prompt

* Max Greeting Time (s):	<input style="width: 60%;" type="text" value="60"/>
Dial "0" for Operator:	<input type="checkbox"/>
Operator Type:	<input style="width: 60%;" type="text" value="Extension"/>
Operator Extension:	<input style="width: 60%;" type="text" value="None"/>
* Max Messages Per Folder:	<input style="width: 60%;" type="text" value="50"/>
Max Message Time:	<input style="width: 60%;" type="text" value="15 minutes"/>
Min Effective Message Time:	<input style="width: 60%;" type="text" value="3 seconds"/>
Announce Message Caller-ID:	<input type="checkbox"/>
Announce Message Duration:	<input type="checkbox"/>
Play Envelope:	<input checked="" type="checkbox"/>
Play Most Recent First:	<input type="checkbox"/>
Allow User Review:	<input type="checkbox"/>
Voicemail Remote Access:	<input type="checkbox"/>
Forward Voicemail to Peered UCMs:	<input type="checkbox"/>
Voicemail Password:	<input style="width: 60%;" type="text"/>
Format:	<input style="width: 60%;" type="text" value="GSM"/>

Figure 173: Voicemail Settings



**Table 80: Voicemail Settings**

<b>Max Greeting</b>	Configure the maximum number of seconds for the voicemail greeting. The default setting is 60 seconds.
<b>Dial '0' For Operator</b>	If enabled, the caller can press 0 to exit the voicemail application and connect to the configured operator's extension.
<b>Operator Type</b>	Select extension or Ring group as Operator type.
<b>Operator Extension</b>	Select the operator extension, which will be dialed when users press 0 to exit voicemail application. The operator extension can also be used in IVR option.
<b>Max Messages Per Folder</b>	Configure the maximum number of messages per folder in users' voicemail. The valid range 10 to 1000. The default setting is 50.
<b>Max Message Time</b>	Select the maximum duration of the voicemail message. The message will not be recorded if the duration exceeds the max message time. The default setting is 15 minutes. The available options are: <ul style="list-style-type: none"> <li>• 1 minute</li> <li>• 2 minutes</li> <li>• 5 minutes</li> <li>• 15 minutes</li> <li>• 30 minutes</li> <li>• Unlimited</li> </ul>
<b>Min Effective Message Time</b>	Configure the minimum effective duration (in seconds) of a voicemail message. Messages will be automatically deleted if the duration is shorter than the Min Effective Message Time. The default setting is 3 seconds. The available options are: <ul style="list-style-type: none"> <li>• No minimum</li> <li>• 1 second</li> <li>• 2 seconds</li> <li>• 3 seconds</li> <li>• 4 seconds</li> <li>• 5 seconds</li> </ul> <p><b>Note:</b> Silence and noise duration are not counted in message time.</p>
<b>Announce Message Caller-ID</b>	If enabled, the caller ID of the user who has left the message will be announced at the beginning of the voicemail message. The default setting is "No".
<b>Announce Message Duration</b>	If enabled, the message duration will be announced at the beginning of the voicemail message. The default setting is "No".
<b>Play Envelope</b>	If enabled, a brief introduction (received time, received from, and etc) of each message will be played when accessed from the voicemail application. The default setting is "Yes".





<b>Play from Last</b>	If enabled, UCM6510 will play from the voice message left most recently; if disabled, UCM6510 will play from the earliest left voice message
<b>Allow User Review</b>	If enabled, users can review the message following the IVR before sending the message out. The default setting is "No".
<b>Voicemail Remote Access</b>	<p>If enabled, external callers routed by DID and reaching VM will be prompted by the UCM with 2 options:</p> <ul style="list-style-type: none"> <li>• <b>Press 1 to leave a message.</b> To leave a message for the extension reached by DID.</li> <li>• <b>Press 2 to access voicemail management system.</b> This will allow caller to access any extension VM after entering extension number and its VM password.</li> </ul> <p><b>Note:</b> This option applies to inbound call routed by DID only. The default setting is "Disabled".</p>
<b>Forward Voicemail to Peered UCMs</b>	<p>Enables the forwarding of voicemail to remote extensions on peered SIP trunks.</p> <p>The default setting is "Disabled".</p>
<b>Voicemail Password</b>	Configures the Voicemail password that will be used for extensions that are reset.
<b>Format</b>	Select WAV or GSM format.

**Note:** Resetting an extension will reset Voicemail Password, Send Voicemail to Email, and Keep Voicemail after Emailing values to default. Previous custom voicemail prompts and messages will be deleted.

## Access Voicemail

If the voicemail is enabled for UCM6510 extensions, the users can dial the voicemail access number (by default \*97) to access their extension's voicemail. The users will be prompted to enter the voicemail password and then can enter digits from the phone keypad to navigate in the IVR menu for different options. Otherwise the user can dial the voicemail access code (by default \*98) followed by the extension number and password in order to access to that specific extension's voicemail.

Table 81: Voicemail IVR Menu

Main Menu	Sub Menu 1	Sub Menu 2
1 – New messages	3 - Advanced options	1 - Send a reply
		2 - Call the person who sent this message
		3 - Hear the message envelop
		4 - Leave a message
		* - Return to the main menu



	5 - Repeat the current message	
	7 - Delete this message	
	8 - Forward the message to another user	
	9 - Save	
	* - Help	
	# - Exit	
<b>2 – Change folders</b>	0 - New messages	
	1 - Old messages	
	2 - Work messages	
	3 - Family messages	
	4 - Friend messages	
	# - Cancel	
<b>3 – Advanced options</b>	1 - Send a reply	
	2 - Call the person who sent this message	
	3 - Hear the message envelop	
	4 - Leave a message	
	* - Return to the main menu	
<b>0 – Mailbox options</b>	1 - Record your unavailable message	1 - Accept this recording
		2 - Listen to it
		3 - Re-record your message
	2 - Record your busy message	1 - Accept this recording
		2 - Listen to it
		3 - Re-record your message
	3 - Record your name	1 - Accept this recording
		2 - Listen to it
		3 - Re-record your message
	4 - Record temporary greeting	1 - Accept this recording
		2 - Listen to it
		3 - Re-record your message
	5 - Change your password	
	* - Return to the main menu	



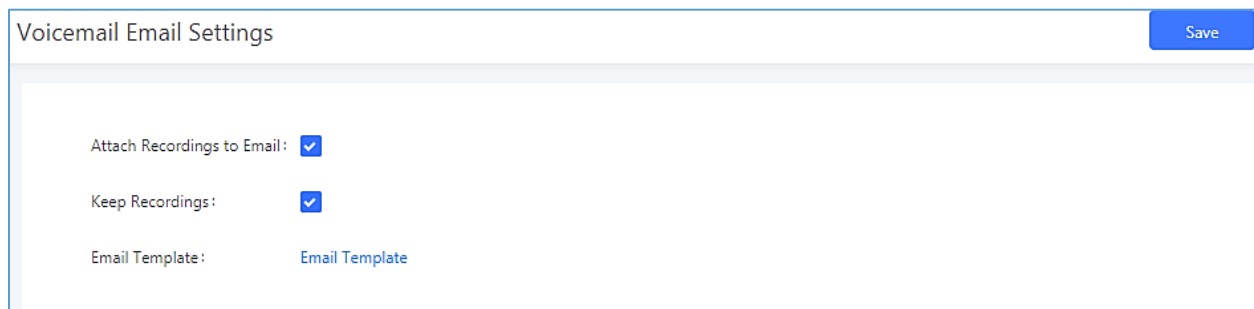
## Leaving Voicemail

If an extension has voicemail enabled under basic settings “**Extension/Trunk → Extensions → Basic Settings**” and after a ring timeout or user not available, the caller will be automatically redirected to the voicemail in order to leave a message on which case they can press # in order to submit the message.

In case if the caller is calling from an internal extension, they will be directly forwarded to the extension’s voicemail box. But if the caller is calling from outside the system and the incoming call is routed by DID to the destination extension, then the caller will be prompted with the choice to either press 1 to access voicemail management or press 2 to leave a message for the called extension. This feature could be useful for remote voicemail administration.

## Voicemail Email Settings

The UCM6510 can be configured to send the voicemail as attachment to Email. Click on "Voicemail Email Settings" button to configure the Email attributes and content.



**Figure 174: Voicemail Email Settings**

Click on "Email Template" button to view the default template as an example.

**Table 82: Voicemail Email Settings**

<b>Send Voicemail to Email</b>	If enabled, voicemails will be sent to user's Email address. The default setting is "Yes".
<b>Keep Recordings</b>	If enabled, voicemail will be stored in the UCM6510 after email is sent. The default setting is "Yes".
<b>Template For Voicemail Emails</b>	<p>Fill in the "Subject:" and "Message:" content, to be used in the Email when sending to the user.</p> <p>The template variables are:</p> <ul style="list-style-type: none"> <li>• \t: TAB</li> <li>• \${VM_NAME}: Recipient's first name and last name</li> <li>• \${VM_DUR}: The duration of the voicemail message</li> </ul>



- `${VM_MAILBOX}`: The recipient's extension
- `${VM_CALLERID}`: The caller ID of the person who has left the message
- `${VM_MSGNUM}`: The number of messages in the mailbox
- `${VM_DATE}`: The date and time when the message is left

## Configure Voicemail Group

The UCM6510 supports voicemail group and all the extensions added in the group will receive the voicemail to the group extension. The voicemail group can be configured under Web GUI → **Call Features** → **Voicemail Group**. Click on "Create New Voicemail Group" to configure the group.

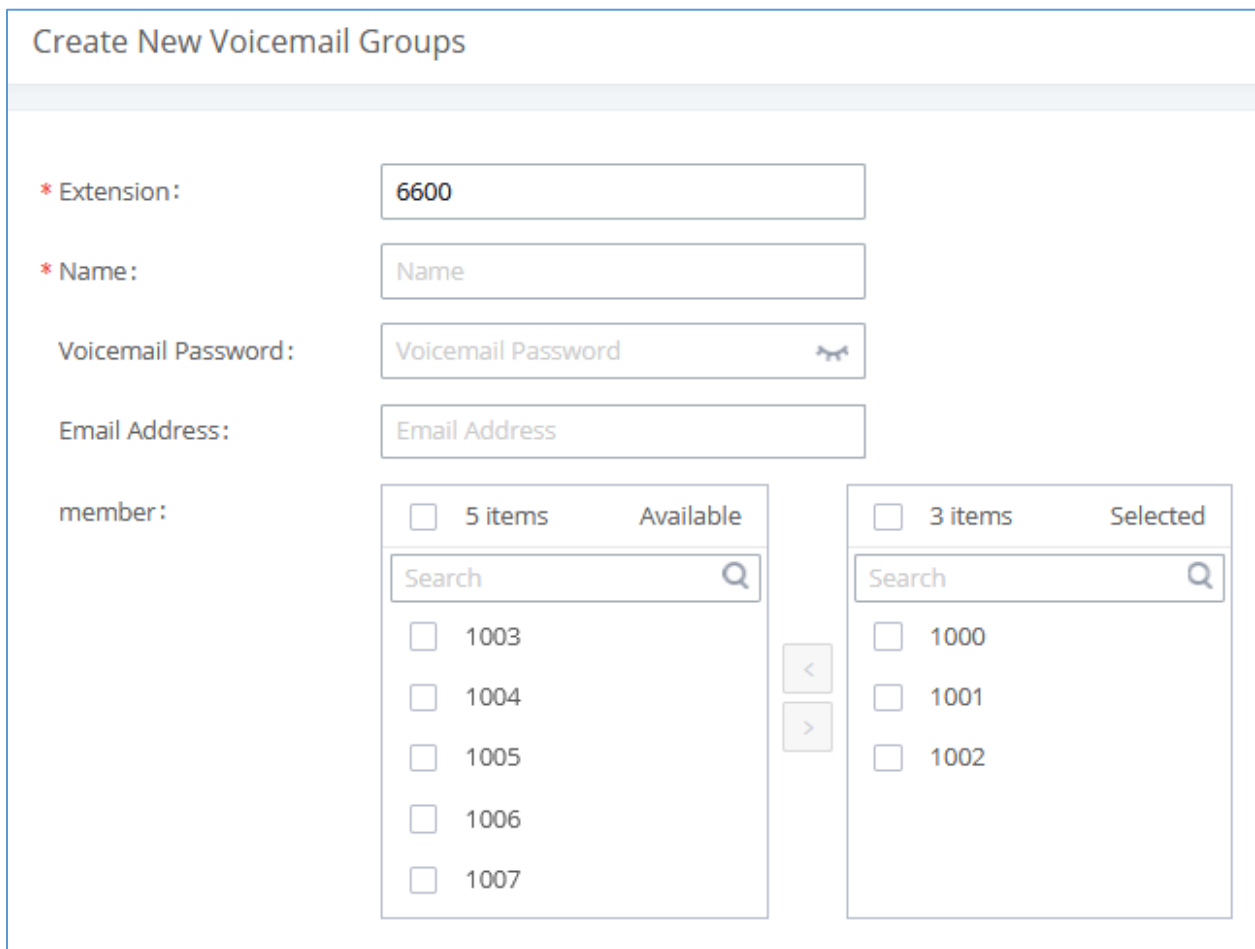


Figure 175: Voicemail Group

Table 83: Voicemail Group Settings

### Voicemail Group Extension

Enter the Voicemail Group Extension. The voicemail messages left to this extension will be forwarded to all the voicemail group members.



<b>Name</b>	Configure the Name to identify the voicemail group. Letters, digits, _ and - are allowed.
<b>Voicemail Password</b>	The Voicemail password for the user to check Voicemail messages.
<b>Email Address</b>	The Email address of current user.
<b>Member</b>	Select available extensions from the left list and add them to the right list. The extensions need to have voicemail enabled to be listed in available mailboxes list. <b>Note:</b> Members selected cannot exceed 30 extensions.

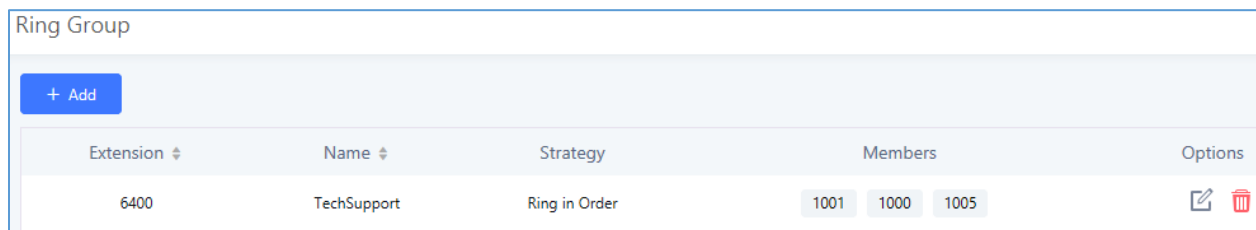


## RING GROUP

The UCM6510 supports ring group feature with different ring strategies applied to the ring group members. This section describes the ring group configuration on the UCM6510.

### Configure Ring Group

Ring group settings can be accessed via Web GUI → **Call Features** → **Ring Group**.



Extension	Name	Strategy	Members	Options
6400	TechSupport	Ring in Order	1001 1000 1005	

Figure 176: Ring Group

- Click on "Create New Ring Group" to add ring group.
- Click on to edit the ring group. The following table shows the ring group configuration parameters.
- Click on to delete the ring group.

Table 84: Ring Group Parameters

<b>Ring Group Name</b>	Configure ring group name to identify the ring group. Letters, digits, _ and - are allowed.
<b>Extension</b>	Configure the ring group extension.
<b>Members</b>	Select available users from the left side to the ring group member list on the right side. Click on     to arrange the order.
<b>LDAP Phonebook</b>	Select available remote users from the left side to the ring group member list on the right side. Click on     to arrange the order. Note: LDAP Sync must be enabled first.
<b>Ring Strategy</b>	Select the ring strategy. The default setting is "Ring in order". <ul style="list-style-type: none"> <li>• <b>Ring simultaneously</b> Ring all the members at the same time when there is incoming call to the ring group extension. If any of the member answers the call, it will stop ringing.</li> </ul>



	<ul style="list-style-type: none"> <li>• <b>Ring in order</b> Ring the members with the order configured in ring group list. If the first member does not answer the call, it will stop ringing the first member and start ringing the second member.</li> </ul>
<b>Music On Hold</b>	Select the “Music On Hold” Playlist of this Ring Group, “Music On Hold” can be managed from the “Music On Hold” panel on the left.
<b>Custom Prompt</b>	<p>This option is to set a custom prompt for a ring group to announce to caller. Click on ‘Prompt’, it will direct the users to upload the customized voice prompts.</p> <p><b>Note:</b> Users can also refer to the page <b>PBX Settings→Voice Prompt→Custom Prompt</b>, where they could record new prompt or upload prompt files.</p>
<b>Ring Timeout for Each Member</b>	<p>Configure the number of seconds to ring each member. If set to 0, it will keep ringing. The default setting is 30 seconds.</p> <p><b>Note:</b> The actual ring timeout might be overridden by users if the phone has ring timeout settings as well.</p>
<b>Auto Record</b>	Once this option is enabled, the calls using this extension or trunk will be automatically recorded.
<b>Endpoint Call Forwarding Support</b>	<p>This allows the UCM to work with endpoint-configured call forwarding settings to redirect calls to ring group. For example, if a member wants to receive calls to the ring group on his mobile phone, he would have to set his endpoint’s call forwarding settings to his mobile number. By default, it is disabled.</p> <p><b>Note:</b> However, this feature has the following limitations:</p> <ul style="list-style-type: none"> <li>• This feature will work only when call forwarding is configured on endpoints, not on the UCM.</li> <li>• If the forwarded call goes through an analog trunk, and polarity reversal is disabled, the other ring group members will no longer receive the call after it is forwarded.</li> <li>• If the forwarded call goes through a VoIP trunk, and the outbound route for it is PIN-protected and requires authentication, the other ring group members will no longer receive the call after it is forwarded.</li> <li>• If the forwarded call hits voicemail, the other ring group members will no longer receive the call.</li> </ul>
<b>Replace Display Name</b>	If enabled, the UCM will replace the caller display name with the Ring Group name the caller know whether the call is incoming from a direct extension or a Ring Group.



<b>Skip Busy Agent</b>	If enabled calls to busy agents will be skipped regardless of call waiting settings and sent to the following available ones. Default is enabled.
<b>Enable Destination</b>	If enabled, users could select extension, voicemail, ring group, IVR, call queue, voicemail group as the destination if the call to the ring group has no answer. <b>Note:</b> Voicemail Password and Email address (limited by 128 characters) are required if voicemail is selected as the destination. Voicemail system will mention if a voicemail is from a ring group.
<b>Default Destination</b>	Configure the Default Destination.





Edit Ring Group: 6400
Save

\* Ring Group Name:

\* Extension:

Members:

1 Available Extensions

Search

1002

3 Selected Extensions

Search

1001

1000 "John DOE"bone

1005 "Marcel LAST"

<
>

LDAP Phonebook:

1 Available LDAP

Search

1002(ou=GSEMEA,dc=pbx,dc=com)

None

0 Selected LDAP

Search

None

<
>

**Ring Group Options**

Ring Strategy:

Music On Hold:

Custom Prompt:  [Prompt](#)

\* Ring Timeout on E...:


Auto Record:

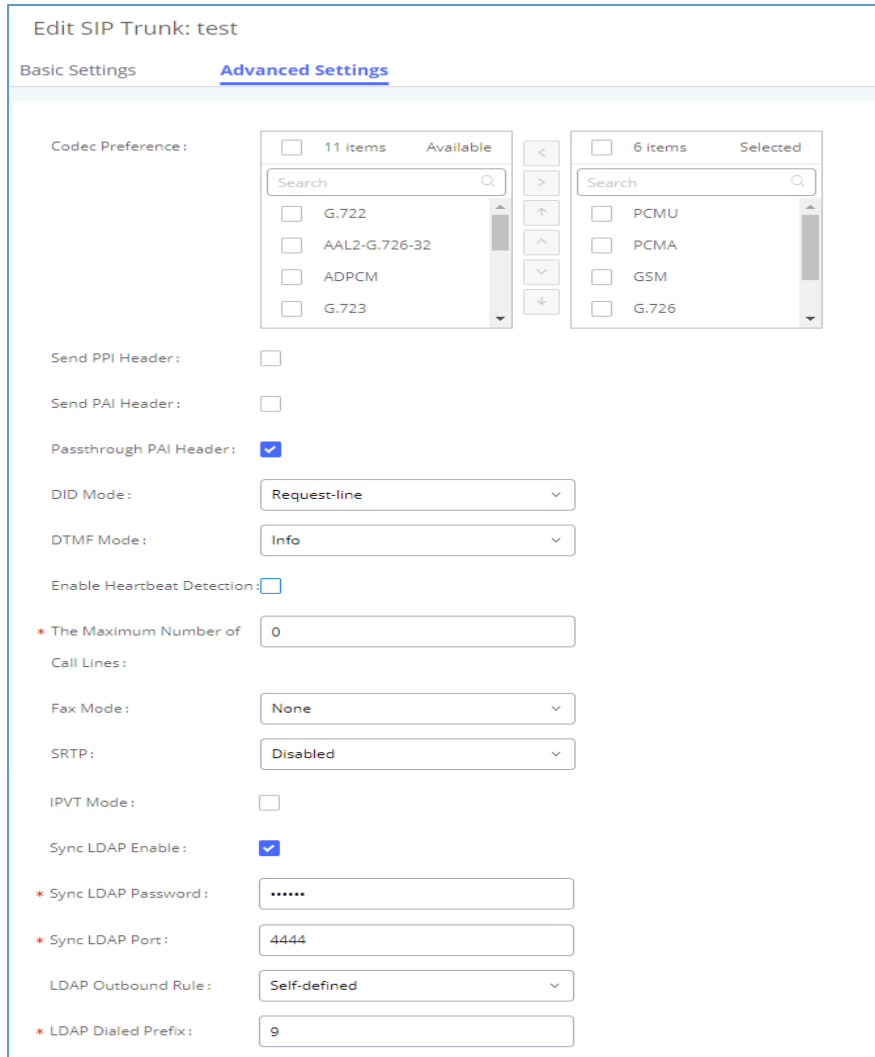
**Figure 177: Ring Group Configuration**

## Remote Extension in Ring Group

Remote extensions from the peer trunk of a remote UCM6510 can be included in the ring group alongside local extensions. An example of Ring Group with peer extensions is presented in the following:

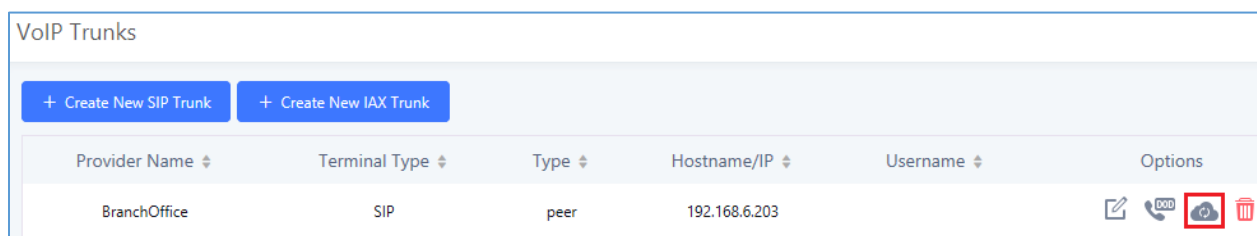
1. Create SIP Trunks from UCM A to UCM B and vice-versa on the **Extension/Trunk→VoIP Trunks**. Additionally, please create the appropriate outbound and inbound routes for these SIP trunks.





2. Click edit button in the menu , and check if **Sync LDAP Enable** is toggled on.



**Figure 178: Sync LDAP Server option**

3. In the scenario that the LDAP is not synced automatically, users can manually sync LDAP phonebooks by clicking on the LDAP sync button that's highlighted in the following image.



Provider Name	Terminal Type	Type	Hostname/IP	Username	Options
BranchOffice	SIP	peer	192.168.6.203		   

**Figure 179: Manually Sync LDAP Server**



4. Under **Ring Groups** setting page, click + Add. **Ring Groups** will be available under Web GUI→**Call Features**→**Ring Groups**.
5. If LDAP phonebook has synced correctly, the remote UCM's extensions should appear in the **Created/Edit Ring Group**→**LDAP phonebook** list.

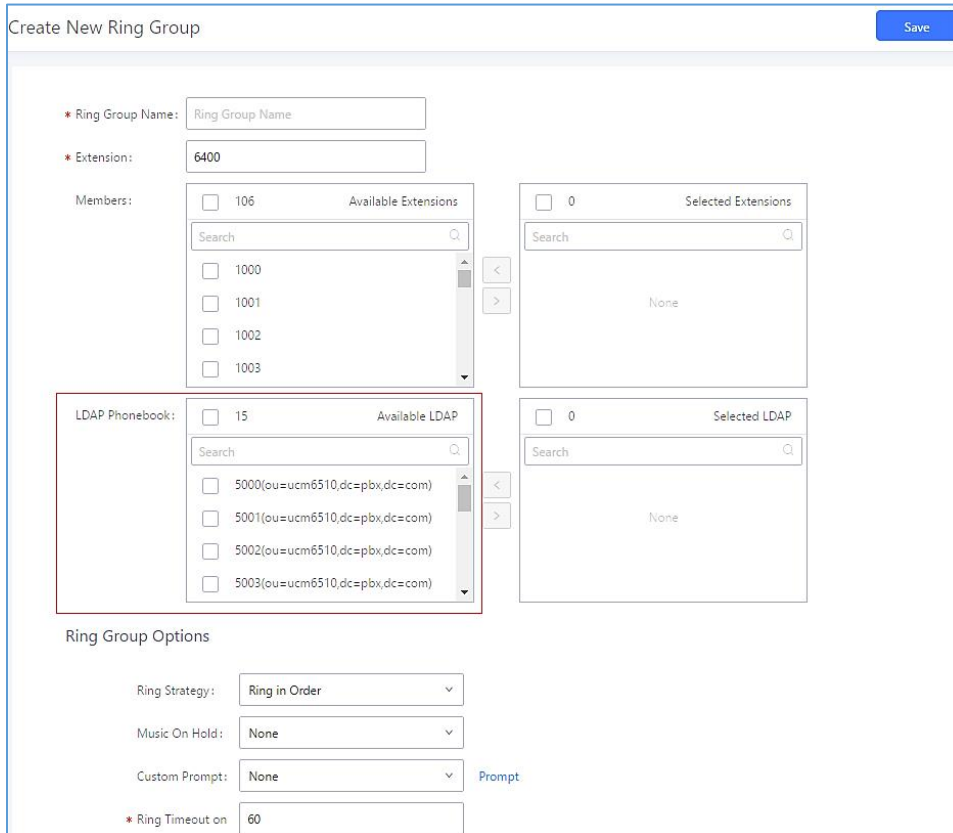




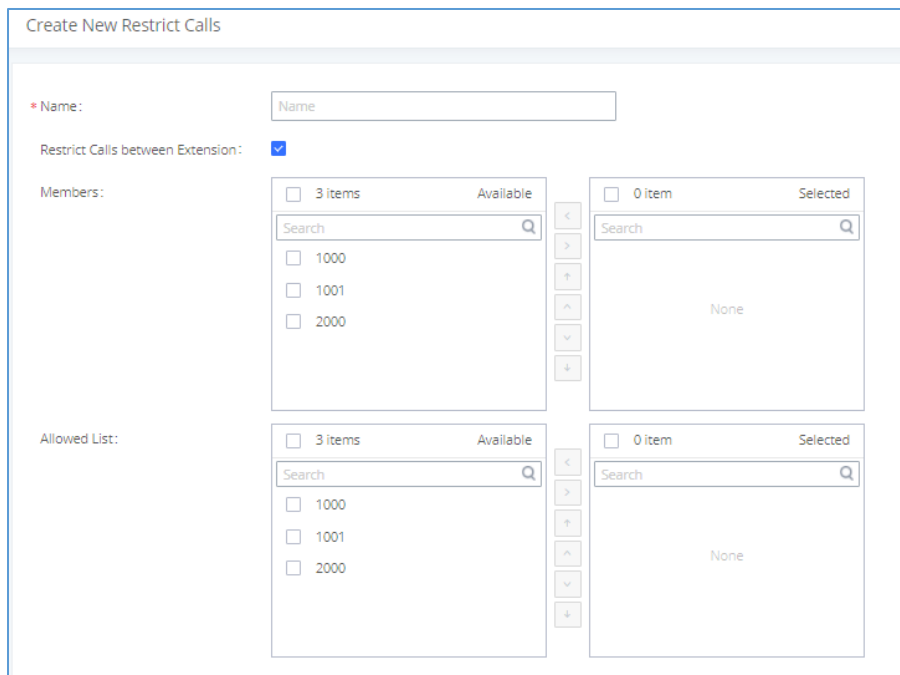
Figure 180 shows the 'Create New Ring Group' configuration page. The 'Members' section is divided into 'Available Extensions' and 'Available LDAP'. The 'Available LDAP' list contains 15 entries, with the first four visible: 5000, 5001, 5002, and 5003, each with a corresponding LDAP ID. The 'Ring Group Options' section includes a dropdown for 'Ring Strategy' set to 'Ring in Order', 'Music On Hold' set to 'None', 'Custom Prompt' set to 'None', and a 'Ring Timeout on' field set to 60. A 'Save' button is located in the top right corner of the form.

**Figure 180: Ring Group Remote Extension**

## RESTRICT CALLS

The Restrict Calls feature allows users to restrict calls between extensions. This section describes the configuration of Restrict Calls feature under Web GUI→**Call Features**→**Restrict Calls**.

- Click on "Add" to add paging/intercom group.
- Click on  to edit the paging/intercom group.
- Click on  to delete the paging/intercom group.



**Figure 181: Restrict Calls**



**Table 85: Restrict Calls configuration Parameters**

<b>Name</b>	Configure restrict calls name.
<b>Restrict Calls between Extension</b>	Toggles the restriction rule on/off.
<b>Members</b>	Selected extensions will not be able to call any extensions besides those in the Allowed List.
<b>Allowed List</b>	The extensions configured in the Members list will only be able to call the extensions selected in this list

## PAGING AND INTERCOM GROUP

Paging and Intercom Group can be used to make an announcement over the speaker on a group of phones. Targeted phones will not ring but answer immediately using speaker. The UCM6510 paging and intercom can be used via feature code to a single extension or a paging/intercom group. This section describes the configuration of paging/intercom group under Web GUI→**Call Features**→**Paging/Intercom**.

### Configure Paging/Intercom Group

- Click on "Add" to add paging/intercom group.
- Click on  to edit the paging/intercom group.
- Click on  to delete the paging/intercom group.
- Click on "Paging/Intercom Group Settings" to edit Alert-Info Header. This header will be included in the SIP INVITE message sent to the callee in paging/intercom call.

### Configure Multicast Paging

Create New Paging/Intercom Groups

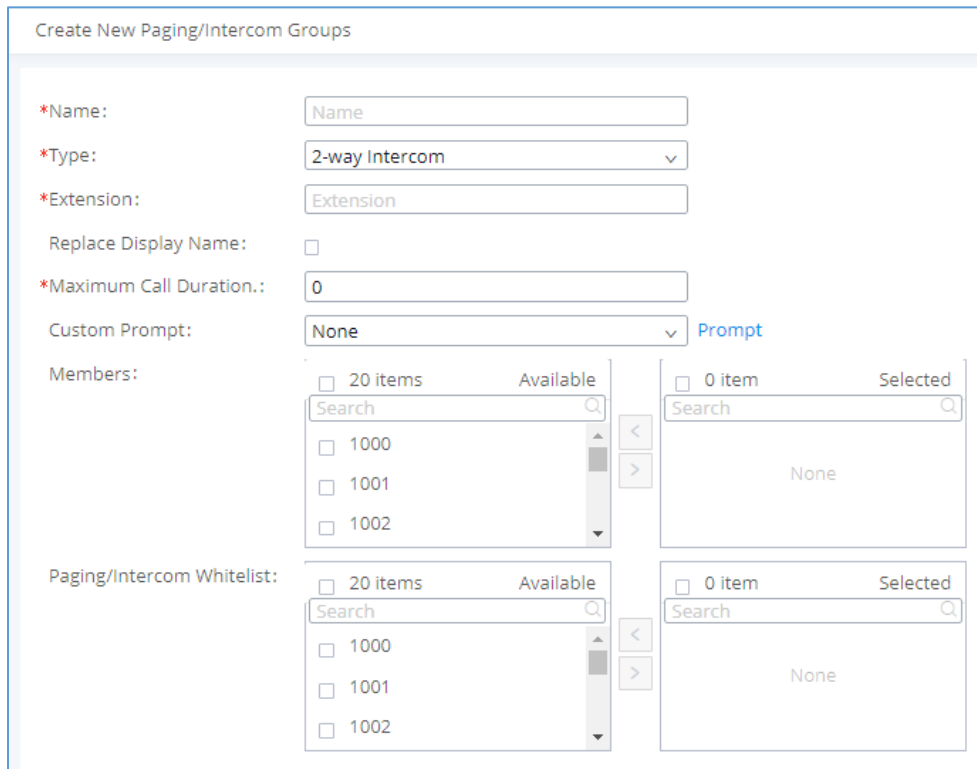
<b>*Name:</b>	<input type="text" value="Name"/>
<b>*Type:</b>	<input style="border-bottom: 1px solid #ccc;" type="text" value="Multicast Paging"/> ▾
<b>*Extension:</b>	<input type="text" value="Extension"/>
<b>*Maximum Call Duration.:</b>	<input type="text" value="0"/>
Custom Prompt:	<input style="border-bottom: 1px solid #ccc;" type="text" value="None"/> ▾ <span style="color: #0070C0; font-weight: bold;">Prompt</span>
<b>*Multicast IP Address:</b>	<input type="text" value="Configure multicast IP address"/>
<b>*Port:</b>	<input type="text" value="Configure the port number"/>

Figure 182: Multicast Paging

**Table 86: Multicast Paging Configuration Parameters**

<b>Name</b>	Configure paging/intercom group name.
<b>Type</b>	Select "Multicast Paging".
<b>Extension</b>	Configure the paging/intercom group extension.
<b>Multicast IP Address</b>	The allowed multicast IP address range is 224.0.1.0 - 238.255.255.255. <b>Note:</b> This field appears only when "Type" is set to "Multicast Paging".
<b>Maximum Call Duration</b>	Specify the maximum call duration in seconds. The default value 0 means no limit.
<b>Custom Prompt</b>	Configure a custom prompt to play to paging callees. Users can now directly upload custom prompts from this page. They do not need to be redirected anymore.
<b>Multicast IP Address</b>	Configure the multicast IP address that endpoints will listen to.
<b>Port</b>	Configure the port for multicast paging. <b>Note:</b> This field appears only when "Type" is set to "Multicast Paging".

### Configure 2-way Intercom



The screenshot shows the configuration interface for a 2-way Intercom group. The form includes the following fields and sections:

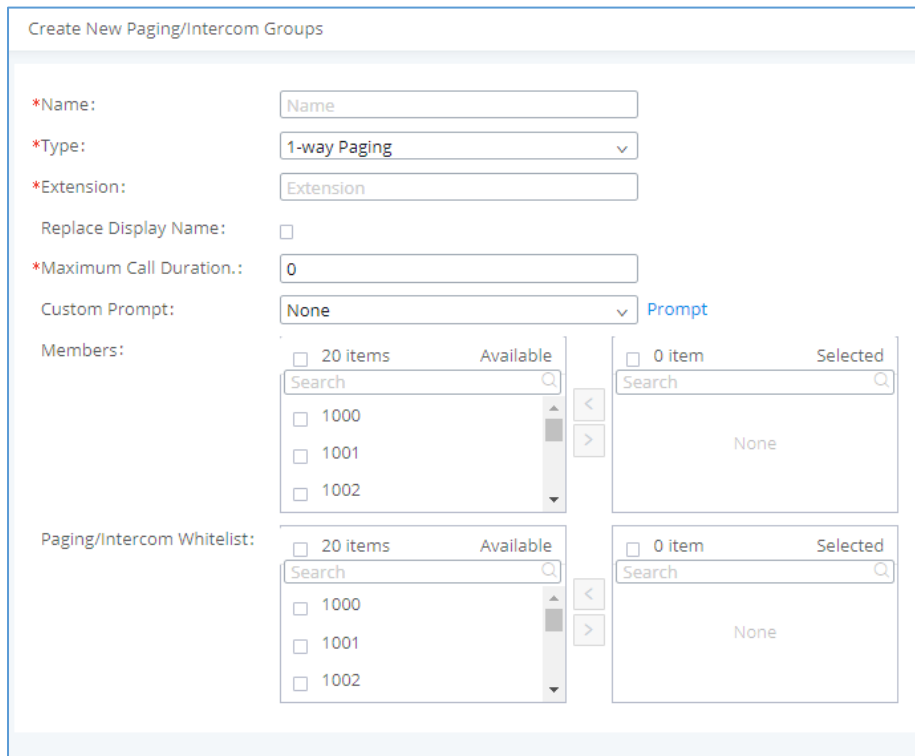
- \*Name:** A text input field with the placeholder "Name".
- \*Type:** A dropdown menu set to "2-way Intercom".
- \*Extension:** A text input field with the placeholder "Extension".
- Replace Display Name:** An unchecked checkbox.
- \*Maximum Call Duration.:** A text input field with the value "0".
- Custom Prompt:** A dropdown menu set to "None" with a "Prompt" link next to it.
- Members:** A list management section with two columns: "Available" (containing 20 items, with a search bar and a list of 1000, 1001, 1002) and "Selected" (containing 0 items, with a search bar and "None").
- Paging/Intercom Whitelist:** A list management section with two columns: "Available" (containing 20 items, with a search bar and a list of 1000, 1001, 1002) and "Selected" (containing 0 items, with a search bar and "None").

**Figure 183 : 2-way Intercom**

**Table 87: 2-way Intercom Configuration Parameters**

<b>Name</b>	Configure paging/intercom group name.
<b>Type</b>	Select "2-way Intercom".
<b>Extension</b>	Configure the paging/intercom group extension.
<b>Replace Display Name</b>	If enabled, the UCM will replace the caller display name with Paging/Intercom name.
<b>Maximum Call Duration</b>	Specify the maximum call duration in seconds. The default value 0 means no limit.
<b>Custom Prompt</b>	This option is to set a custom prompt for a paging/intercom group to announce to caller. Users can now directly upload custom prompts from this page. They do not need to be redirected anymore.
<b>Members</b>	Select available users from the left side to the paging/intercom group member list on the right.
<b>Paging/Intercom Whitelist</b>	Select which extensions are allowed to use the paging/intercom feature for this paging group.

### Configure 1-way Paging



Create New Paging/Intercom Groups

\*Name:

\*Type:

\*Extension:

Replace Display Name:

\*Maximum Call Duration.:

Custom Prompt:  [Prompt](#)

Members:

20 items Available  0 item Selected

Search

1000  1001  1002

Paging/Intercom Whitelist:

20 items Available  0 item Selected

Search

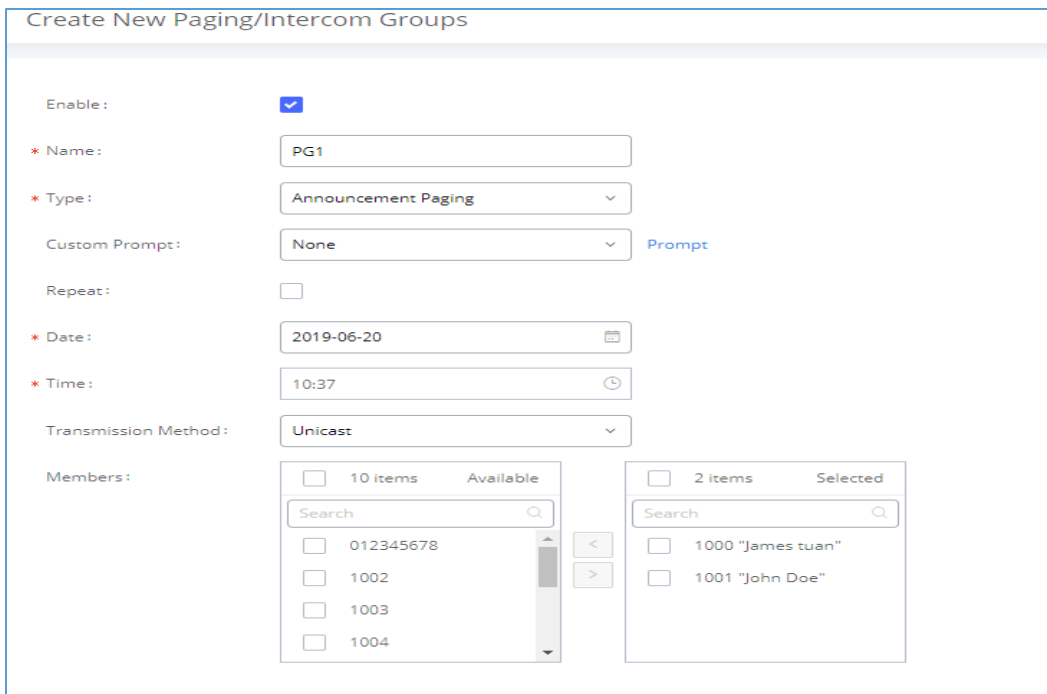
1000  1001  1002

**Figure 184 : 1-way Paging**


**Table 88: 1-way Paging Configuration Parameters**

<b>Name</b>	Configure paging/intercom group name.
<b>Type</b>	Select "1-way Paging".
<b>Extension</b>	Configure the paging/intercom group extension.
<b>Replace Display Name</b>	If enabled, the UCM will replace the caller display name with Paging/Intercom name.
<b>Maximum Call Duration</b>	Specify the maximum call duration in seconds. The default value 0 means no limit.
<b>Custom Prompt</b>	This option is to set a custom prompt for a paging/intercom group to announce to caller. Users can now directly upload custom prompts from this page. They do not need to be redirected anymore.
<b>Members</b>	Select available users from the left side to the paging/intercom group member list on the right.
<b>Paging/Intercom Whitelist</b>	Select which extensions are allowed to use the paging/intercom feature for this paging group.

## Configure Announcement Paging



**Create New Paging/Intercom Groups**

Enable:

\* Name:

\* Type:

Custom Prompt:  [Prompt](#)

Repeat:

\* Date:

\* Time:

Transmission Method:

Members:

10 items Available

Search

- 012345678
- 1002
- 1003
- 1004

2 items Selected

Search

- 1000 "James tuan"
- 1001 "John Doe"

**Figure 185 : Announcement Paging**



**Table 89: Announcement Paging Configuration Parameters**

<b>Enable</b>	Enable/Disable Announcement Paging.
<b>Name</b>	Configure paging/intercom group name.
<b>Type</b>	Select "Announcement Paging".
<b>Custom Prompt</b>	This option is to set a custom prompt for a paging/intercom group to announce to caller. Users can now directly upload custom prompts from this page. They do not need to be redirected anymore.
<b>Repeat</b>	If enabled, the announcement page will be repeated for the selected weekdays.
<b>Include Holidays</b>	Announcement Paging will run during holidays.
<b>Date</b>	Configure Announcement Paging Date.
<b>Time</b>	Configure Announcement Paging Time.
<b>Transmission Method</b>	Configure Announcement Paging transmission method. <ul style="list-style-type: none"> <li>• <b>Unicast:</b> Depending on members selection</li> <li>• <b>Multicast:</b> Depending on Multicast IP address and Port</li> </ul>
<b>Members</b>	Select available users from the left side to the paging/intercom group member list on the right.

### Configure Private Intercom

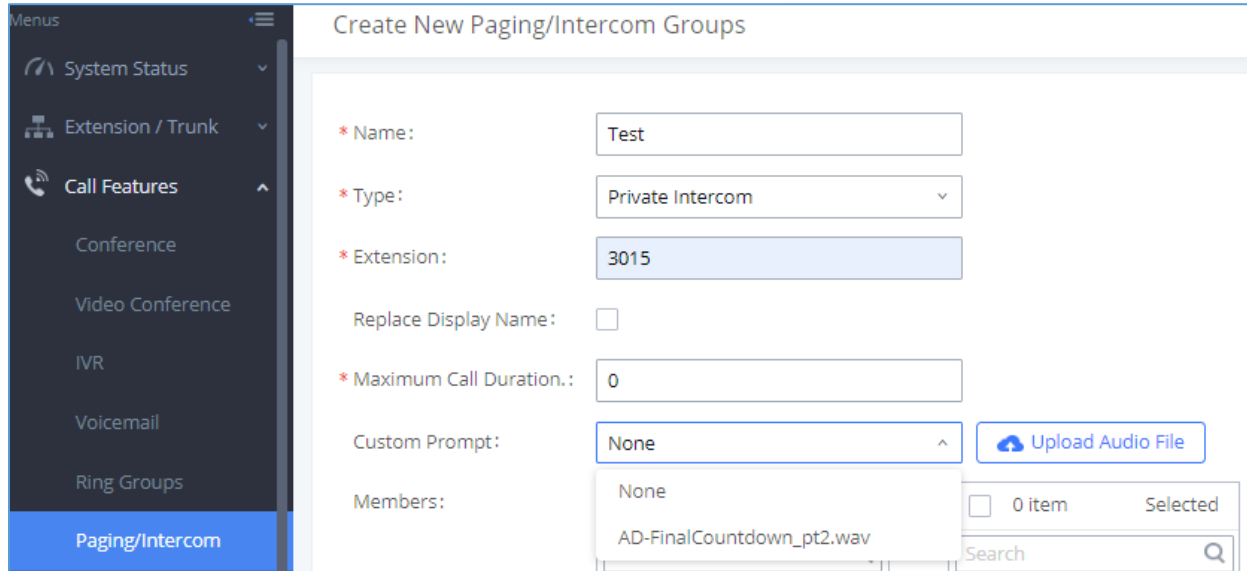
Private Intercom is a new paging type that is meant to be used with Grandstream GSC3510.

<http://www.grandstream.com/products/facility-management/intercoms-paging/product/gsc3510>

In a private intercom:

- The initiator can be heard by all parties
- The initiator can hear only one of the intercom members, which is determined by whose audio is initially detected. Audio from other members cannot be heard until the first responder is done talking.
- Intercom members can hear only the initiator's audio and not other intercom members





The screenshot shows the 'Create New Paging/Intercom Groups' configuration page. The left sidebar contains a 'Menus' section with 'Paging/Intercom' selected. The main form includes the following fields:

- \* Name:** Text input field containing 'Test'.
- \* Type:** Dropdown menu set to 'Private Intercom'.
- \* Extension:** Text input field containing '3015'.
- Replace Display Name:** Unchecked checkbox.
- \* Maximum Call Duration.:** Text input field containing '0'.
- Custom Prompt:** Dropdown menu set to 'None', with an 'Upload Audio File' button to its right.
- Members:** A list box showing 'None' and 'AD-FinalCountdown\_pt2.wav'.

**Figure 186: Private Intercom**

**Table 90: Private Intercom Configuration Parameters**

<b>Name</b>	Configure paging/intercom group name.
<b>Type</b>	Select "Private Intercom".
<b>Extension</b>	Configure the paging/intercom group extension.
<b>Replace Display Name</b>	If enabled, the UCM will replace the caller display name with Paging/Intercom name.
<b>Maximum Call Duration</b>	Specify the maximum call duration in seconds. The default value 0 means no limit.
<b>Custom Prompt</b>	<p>This option is to set a custom prompt for a paging/intercom group to announce to caller. Click on 'Prompt', it will direct the users to upload the customized voice prompts.</p> <p><b>Note:</b> Users can also refer to the page <b>PBX Settings→Voice Prompt→Custom Prompt</b>, where they could record new prompt or upload prompt files.</p>
<b>Members</b>	Select available users from the left side to the paging/intercom group member list on the right.
<b>Paging/Intercom Whitelist</b>	Select which extensions are allowed to use the paging/intercom feature for this paging group.

## Paging/Intercom Group Settings

### Paging & Intercom Settings

\* Alert-info Head...

### Paging/Intercom Feature Code Settings

Custom Prompt:  Prompt

Please go to [Feature Codes](#) Configure Paging/Intercom Feature Code.

Figure 187: Page/Intercom Group Settings

The UCM6510 has pre-configured paging/intercom feature code. By default, the Paging Prefix is \*81 and the Intercom Prefix is \*80. To edit page/intercom feature code, click on "Feature Codes" in the "Paging/Intercom Group Settings" dialog. Or users could go to Web GUI → **Call Features** → **Feature Codes** directly.

## Configure a Scheduled Paging/Intercom

Users can schedule paging/intercom calls by using the Schedule Paging/Intercom page. To schedule, click the Add button on the new page and configure the caller, the group to use, and the time to call out.

### Paging/Intercom Groups

Paging/Intercom Groups [Schedule Paging/Intercom](#)

+ Add

	Caller ↕	Paging/Intercom Group ↕
<input type="checkbox"/>	3000	5000
<input type="checkbox"/>	3002	5001

Total: 2 < 1 >

Figure 188: Schedule Paging/Intercom page



**Table 91: Schedule Paging / Intercom Settings**

<b>Caller</b>	Configure the caller ID for the paging / intercom group.
<b>Paging/Intercom Group</b>	Select the paging / intercom group from the list of the available groups.
<b>Type</b>	Select the type for the scheduled paging / intercom call. The available types are: <b>Single</b> time or <b>Daily, Weekly</b> basis. Default is "Single".
<b>Start Time</b>	Configure the start time of the scheduled paging / intercom call.
<b>Include Holidays</b>	If enabled Paging/Intercom will run during holidays.
<b>Action Status</b>	Display the action status of the scheduled paging / intercom call.

**Create New Scheduled Paging/Intercom**

---

\* Caller:

\* Paging/Intercom Group:

Type:

Include Holidays:

\* Start Time:

**Figure 189: Creating a Scheduled Paging/Intercom Call**

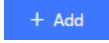




## CALL QUEUE

The UCM6510 provides call center functionality through its Call Queue feature. Static and dynamic agents can be assigned to queue groups to handle varying loads of call traffic. This section describes the configuration of call queues in the **Call Features**→**Call Queue** page.

### Configure Call Queue

Call queue settings can be accessed via Web GUI→**Call Features**→**Call Queue**.

- Click on  to add call queue.
- Click on  to edit the call queue. The call queue configuration parameters are listed in bellow table.
- Click on  to delete the call queue.

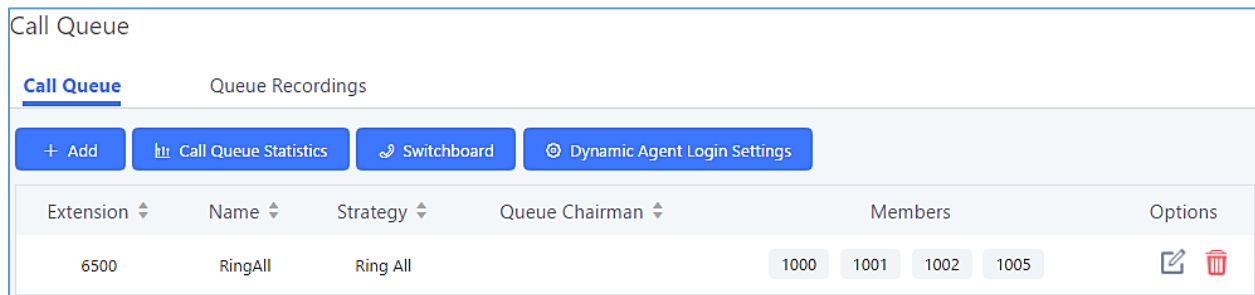


Figure 190: Call Queue

Table 92: Call Queue Configuration Parameters



Basic Settings	
<b>Extension</b>	Configure the call queue extension number.
<b>Name</b>	Configure the call queue name to identify the call queue.
<b>Strategy</b>	Select the strategy for the call queue. <ul style="list-style-type: none"> <li>• <b>Ring All</b> Ring all available Agents simultaneously until one answers.</li> <li>• <b>Linear</b> Ring agents in the specified order.</li> <li>• <b>Least Recent</b> Ring the agent who has been called the least recently.</li> <li>• <b>Fewest Calls</b></li> </ul>

	<p>Ring the agent with the fewest completed calls.</p> <ul style="list-style-type: none"> <li>• <b>Random</b> Ring a random agent.</li> <li>• <b>Round Robin</b> Ring the agents in Round Robin scheduling with memory.</li> </ul> <p>The default setting is "Ring All".</p>
<b>Music On Hold</b>	<p>Select the Music On Hold playlists for the call queue.</p> <p><b>Note:</b> Music On Hold playlist can be managed from Web GUI → <b>PBX Settings</b> → <b>Music On Hold</b>.</p>
<b>Max Queue Length</b>	<p>Configure the maximum number of calls that can be queued up at once. This number does not include calls that have been connected with agents. It only includes calls not connected yet. The default setting is 0, which means unlimited. When the maximum value is reached, the caller will be treated with busy tone followed by the next calling rule after attempting to enter the queue.</p>
<b>Wrapup Time</b>	<p>Configure the number of seconds an agents must wait to receive a new call after completing a previous call. If set to 0, an agent can receive a new call as soon as a previous call is completed. Default is 10 seconds.</p>
<b>Retry Time</b>	<p>Configure the number of seconds to wait before ringing the next agent.</p>
<b>Ring Time</b>	<p>Configure the number of seconds to ring an agent before proceeding to ring the next agent.</p> <p>The default setting is 30 seconds.</p>
<b>Auto Record</b>	<p>If enabled, the calls on the call queue will be automatically recorded. The recording files can be accessed in Queue Recordings under Web GUI → <b>Call Features</b> → <b>Call Queue</b>.</p>
<b>Enable Record Feature Code</b>	<p>If enabled, call queue members can use recording feature code to pause or restore current queue's recording when Auto Record is enabled for the queue. Default code for Start/Stop Call Recording is *3.</p>
<b>Welcome Prompt</b>	<p>If enabled, users can upload an audio file that will be played as an Initial tone when dialing the queue number.</p>
<b>Max Wait Time</b>	<p>Configure the maximum amount of seconds callers can wait before being disconnected from the queue. Default setting is 60 seconds, if left blank, there will be no limit to the amount of time a caller waits in queue.</p> <p><b>Note:</b> It is recommended to configure "Wait Time" longer than the "Wrapup Time".</p>
<b>Destination</b>	<p>Configure the destination that callers will be redirected to after the configured Max Wait Time has passed. Default is "Hang up".</p>
<b>Reset Agent Call Counter - Enable</b>	<p>If enabled, the agent call completion count will be reset based on the frequency</p>



	set in the repeat and Date/Time fields.
<b>Repeat</b>	Specifies the frequency at which the agent call counter will be reset.
<b>Destination Prompt Cycle</b>	Configure the frequency to play the destination prompt to callers waiting in queue.
<b>Custom Prompt</b>	The custom prompt to play to callers waiting in queue once the destination prompt cycle period has been reached. Callers can press 1 to be redirected to the destination configured in <b>Destination</b> .
<b>Destination</b>	Select failover destination to redirect callers to after pressing 1 during the custom prompt.
<b>Advanced Settings</b>	
<ul style="list-style-type: none"> <li>- <b>Virtual Queue</b></li> <li>- <b>Position Announcement</b></li> <li>- <b>Queue Chairman</b></li> </ul>	Refer to <b>Call Center Settings &amp; Enhancements</b> section for detailed information about these features.
<b>Enable Agent Login</b>	Enables quick static agent login/logout via GXP21xx softkeys. Supports GXP21XX endpoint on firmware 1.0.9.18 and higher.
<b>Leave When Empty</b>	<p>Configure whether or not callers will be disconnected from the queue based on agent availability.</p> <ul style="list-style-type: none"> <li>• <b>Yes</b> Callers will be disconnected from the queue if all agents are paused or unavailable.</li> <li>• <b>No</b> Never disconnect the callers from the queue when the queue is empty.</li> <li>• <b>Strict</b> Callers will be disconnected from the queue if there are no agents logged in or if all agents are paused or unavailable.</li> </ul>
<b>Dial in Empty Queue</b>	<p>Configure whether the callers can dial into a call queue if the queue has no agent. The default setting is "No".</p> <ul style="list-style-type: none"> <li>• <b>Yes</b> Callers can always dial into a call queue.</li> <li>• <b>No</b> Callers cannot dial into a queue if all agents are paused or unavailable.</li> <li>• <b>Strict</b> Callers will be disconnected from the queue if there are no agents logged in or if all agents are paused or unavailable.</li> </ul>
<b>Failover Destination</b>	Configure the destination to redirect callers to base on the Leave When Empty



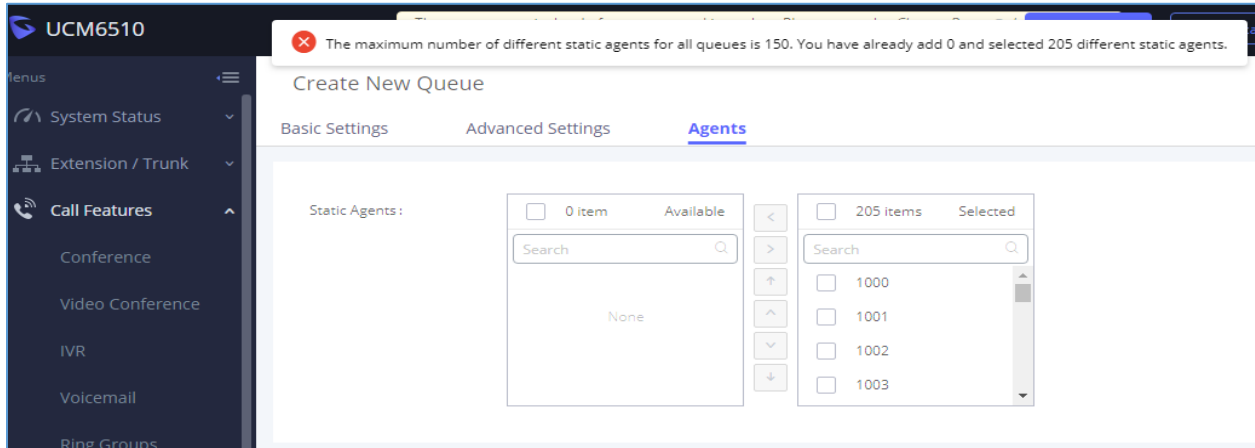
	and Dial in Empty Queue values: <ul style="list-style-type: none"> <li>• Play Sound.</li> <li>• Extension.</li> <li>• Voicemail.</li> <li>• Queues.</li> <li>• Ring Group.</li> <li>• Voicemail Group.</li> <li>• IVR.</li> <li>• External Number.</li> </ul>
<b>Report Hold Time</b>	If enabled, the UCM6510 will report to the agent the amount of time of the caller waited before being connected. The default is disabled.
<b>Replace Display Name</b>	If enabled, the UCM will replace the caller display name with the Call Queue name so that the caller knows the call is incoming from a Call Queue.
<b>Enable Feature Codes</b>	Enable feature codes option for call queue. For example, *83 is used for “Agent Pause”. <b>Note:</b> Callers can no longer use feature codes in established callbacks.
<b>Dynamic Login Password</b>	If enabled, the configured PIN number is required for dynamic agent to log in. The default setting is disabled.
<b>Alert-Info</b>	Configure the call destination for the call to be routed to if no agent in this call queue answers the call.
<b>Agents</b>	
<b>Agents</b>	Go to “Agents” Tab and Select the available users to be the static agents in the call queue. Choose from the available users on the left to the static agents list on the right. Click on   to choose. And use UP and Down arrow to select the order of the agent within the call queue.

### Static Agents limitation:

To guarantee a high level of audio quality with the call queue feature, UCMs will limit the number of static agents allowed to be assigned depending on the UCM model used. If the user attempts to configure the number of static agents to be more than the maximum allowed number, a warning message will appear.







**Figure 191: Static Agents Limitation**

The following table lists the maximum number of static agents for each UCM model:

**Table 93: MaxStatic Agents in Call Queue**

UCM Model	Max Static Agents in Call Queue
UCM6202	22
UCM6204	23
UCM6208	34
UCM6510	75

- Click on "Global Queue Settings" to configure Agent Login Extension Postfix and Agent Logout Extension Postfix. Once configured, users could log in the call queue as dynamic agent.

### Dynamic Agent Login Settings

---

Agent Login Extension P...



Agent Logout Extension ...

Example:                    If Queue Extension is 6500,  
                                   Agent Login Extension Postfix is \*,  
                                   Agent Logout Extension Postfix is \*\*,  
                                   Dial **6500\*** to log in, dial **6500\*\*** to log out.

**Note:** Remove postfix will lead the agent that has  
                                   not log out yet cannot logout.


**Figure 192: Agent Login Settings**

For example, if the call queue extension is 6510, Agent Login Extension Postfix is \* and Agent Logout Extension Postfix is \*\*, users could dial 6510\* to login to the call queue as dynamic agent and dial 6510\*\* to logout from the call queue. Dynamic agent does not need to be listed as static agent and can log in/log out at any time.

- Call queue feature code "Agent Pause" and "Agent Unpause" can be configured under Web GUI→**Call Features**→**Feature Codes**. The default feature code is \*83 for "Agent Pause" and \*84 for "Agent Unpause".
- Queue recordings are shown on the Call Queue page under “Queue Recordings” Tab. Click on  to download the recording file in .wav format; click on  to delete the recording file. To delete multiple recording files by one click, select several recording files to be deleted and click on “Delete Selected Recording Files” or click on “Delete All Recording Files” to delete all recording files.

## Call Center Settings & Enhancements

UCM supports additional call center features such as virtual call queue and position announcement, allowing callers to know their current position in the queue and providing them the option to either stay in the queue or request for callback once an agent is available.

To configure these, click on the  button for a queue group and click on the Advanced Settings tab. The following options are available:



**Table 94: Call Center Parameters**

<b>Enable Virtual Queue</b>	Enable virtual queue to activate call center features.
<b>Virtual Queue Period</b>	Configure the amount of seconds a caller must wait before the virtual queue prompts is played to them. Default is 20 sec.
<b>Virtual Queue Mode</b>	<p><b>Timeout Mode:</b> After the virtual queue period passes, the caller will enter the virtual call queue and be presented with a menu to choose an option, the choices can be customized from Global Queue Settings page.</p> <p><b>DTMF Mode:</b> on this mode, the callers can activate the virtual queue by pressing 2, then they will be presented with the menu to choose an option as bellow:</p> <ul style="list-style-type: none"> <li>• Press * to set current number as callback number.</li> <li>• Press 0 to set a callback number different than current caller number.</li> <li>• Press # to keep waiting on the call queue.</li> </ul>
<b>Virtual Queue Outbound Prefix</b>	System will add this prefix to dialed numbers when calling back users.
<b>Enable Virtual Queue Timeout</b>	If enabled agents will have a set amount of time to answer a virtual queue callback.
<b>Write Timeout</b>	Configure the virtual queue callback timeout period in seconds.
<b>Enable Position Announcement</b>	<p>If enabled, callers' position in queue will be announced based on the frequency set in <b>Position Announcement Interval</b></p> <p><b>Note:</b> Queue position will be announced to the caller upon entering the queue.</p>
<b>Position Announcement Interval</b>	Configure the frequency of the caller position announcement.
<b>Enable Hold time Announcement</b>	<p>Enable the announcement of the estimated hold time to the caller periodically.</p> <p><b>Note:</b> Hold time will not be announced if less than one minute.</p>
<b>Queue Chairman</b>	<p>Select the extension to act as chairman of the queue (monitoring).</p> <p><b>Note:</b> One queue can have up to 3 chairmen.</p>
<b>Enable Agent Login</b>	<p>Enables quick static agent login/logout via GXP21xx softkeys. Supports GXP21XX endpoint on firmware 1.0.9.18 and higher.</p> <p><b>Notes:</b></p> <ul style="list-style-type: none"> <li>✓ After enabling the feature, users need to set the option on GXP21XX phone under "<b>Account→SIP Settings→Advanced Features→Special Feature</b>" to "UCM Call Center" to display a softkey on the phone to login/logout.</li> <li>✓ When this option is enabled, dynamic agent login will be no longer supported.</li> <li>✓ In case of concurrent registrations, changing agent status on one phone (login/logout) will be reflected on all phones.</li> </ul>



**Autofill**

Toggles the way UCM handles and distributes call traffic

**Queue Auto fill enhancement:**

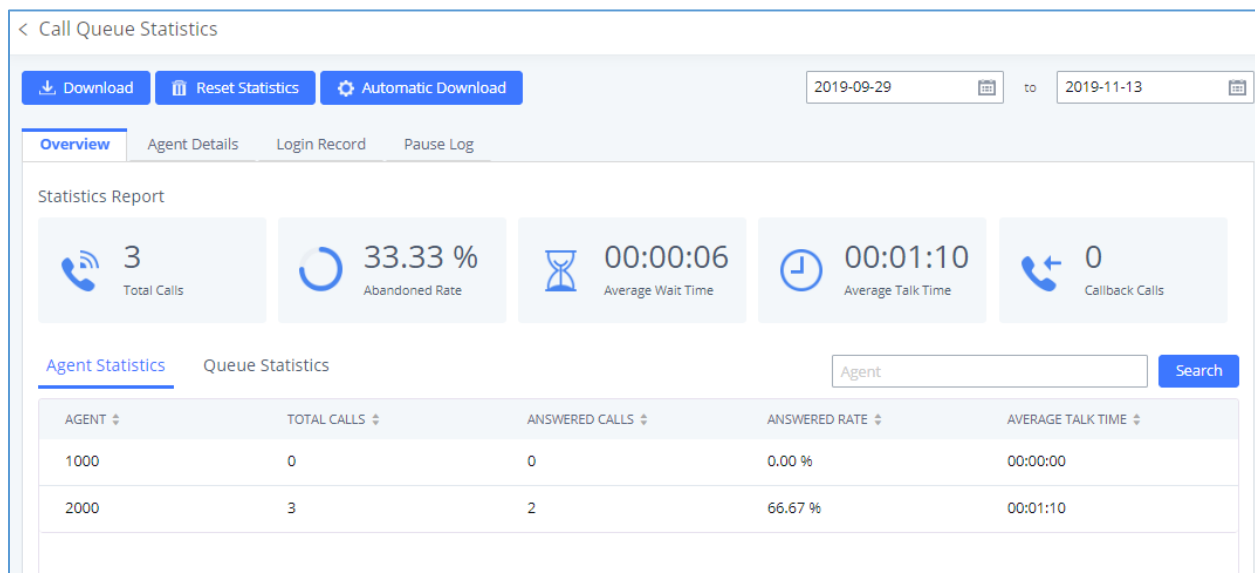
In previous UCM firmware, the call queue has a serial type behavior in that the queue will make all waiting callers wait in the queue even if there is more than one available agents ready to take calls until the head caller is connected with the member they were trying to get to. The next waiting caller in line then becomes the head caller, and they are then connected with the next available member and all available members and waiting callers waits while this happens.

Starting from 1.0.14.x, the waiting callers are connecting with available members in a parallel fashion until there are no more available members or no more waiting callers.

For example, in a call queue with linear method, if there are two available agents, when two callers call in the queue at the same time, UCM will assign the two callers to each of the two available agents at the same time, rather than assigning the second caller to second available agent after the first agent answers the call from the first caller

## Queue Statistics

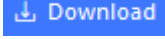
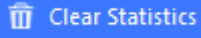
Along with the mentioned call center features; UCM6510 offers detailed call queue statistics, allowing system administrators to make informed decisions regarding call distribution and handling.

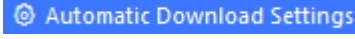


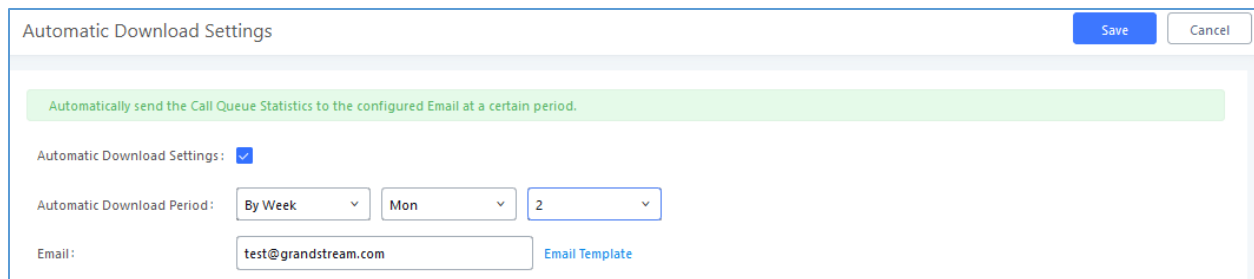
**Figure 193: Call Queue Statistics**

Select the time interval along with the queue(s) and agent(s) to get detailed statistics.



User can download statistics on CSV format by clicking on the download button , also the statistics can be cleared using “Clear Statistics” button .

The statistics can be automatically sent to a specific email address on a preconfigured Period, this can be done by clicking on “Automatic Download Settings” button , and user will be directed to below page where he can configure the download period (Day/Week/Month) and the Email where the statistics will be sent (Email settings should be configured correctly):



**Figure 194 : Automatic Download Settings - Queue Statistics**

Significantly more information is now available UCM's queue statistics page. In addition to the information presented in previous firmware, users can now view a call log that displays calls to all agents and queues, a dynamic agent login/logout record, and a pause log. Statistics reports for these new pages can be obtained by pressing the Download button in the top left corner of the Call Queue Statistics page. The reports are in .CSV format and will be packaged into a single tar.gz file upon download.

## Agent Details

**Agent Details** is a call log that shows every call to each individual agent from all queues. The following information is available:

- Time – the date and time the call was received.
- Agent – the agent that was rung for the call.
- Queue – the queue that the call went to.
- Caller ID Number – the CID of the caller
- Abandoned – indicates whether the call was picked up or not by that specific agent. If the call rang several agents simultaneously, and this specific agent did not pick up the call, the call will be considered abandoned even if a different agent in the same queue picked it up.
- Wait Time – the amount of time that the call was waiting in queue after dialing in.
- Talk Time – the duration of the call after it was picked up by agent.



TIME	AGENT	QUEUE	CALLER ID NUMBER	ABANDONED	WAIT TIME	TALK TIME
2019-11-08 10:56:36	2000	6500	1000	No	00:00:05	00:00:29
2019-11-08 11:09:07	2000	6500	1000	No	00:00:07	00:01:51
2019-11-08 11:18:17	2000	6500	1000	Yes	00:00:04	00:00:00

**Figure 195: Agent details**

## Login Record

**Login Record** is a report that shows the timestamps of dynamic agent logins and logouts and calculates the amount of time the dynamic agents were logged in. Dynamic agents are extensions that log in and out either via agent login/logout codes (configured in *Global Queue Settings* page) or by using the GXP21xx call queue softkey. A new record will be created only when an agent logs out. The following information is available:

- Agent – the extension that logged in and out.
- Queue – the queue that the extension logged in and out of.
- Login Time – the time that the extension logged into the queue.
- Logout Time – the time that the extension logged out of the queue.
- Login Duration – the total length of time that the extension was logged in.

AGENT	QUEUE	LOGIN TIME	LOGOUT TIME	LOGIN DURATION
2000	6500	2019-11-08 09:48:53	2019-11-08 09:53:00	00:04:07
2000	6500	2019-11-08 09:53:10	2019-11-08 09:55:22	00:02:12

**Figure 196: Login Record**

## Pause Log

**Pause Log** is a report that shows the times of agent pauses and unpauses and calculates the amount of time that agents are paused. If an agent is part of several queues, an entry will be created for each queue. An entry will only be created after an agent unpauses. The following information is available:

- Agent – the extension that paused and unpaused
- Queue – the queue that the agent is in.
- Pause Time – the time that the agent paused.
- Resume Time – the time that the agent unpaused.



- Pause Duration – the total length of time the agent was paused for.

Overview Agent Details Login Record <b>Pause Log</b>				
Statistics Report				
AGENT	QUEUE	PAUSE TIME	RESUME TIME	PAUSE DURATION
2000	6500	2019-11-08 11:32:00	2019-11-08 11:33:33	00:01:33
2000	6500	2019-11-08 11:32:00	2019-11-08 11:33:33	00:01:33

Figure 197: Pause Log

## Global Queue Settings

As explained before, under this section users can configure the feature codes for Dynamic agent login and logout, and also can now customize the keys for virtual queue options like shown below.

### Global Queue Settings

#### Dynamic Agent Login Settings

Agent Login Code Suffix:

Agent Logout Code Suffix:

Example: If 6500 is the queue extension,  
 Agent Login Extension Suffix is \*,  
 Agent Logout Extension Suffix is \*\*,  
 dial **6500\*** to log in and **6500\*\*** to log out.

#### Virtual Queue Callback Key Settings

\* Call Back Current Number:

\* Custom Callback Number:

\* Continue Waiting:

Figure 198: Global Queue Settings

Table 95: Global Queue Settings

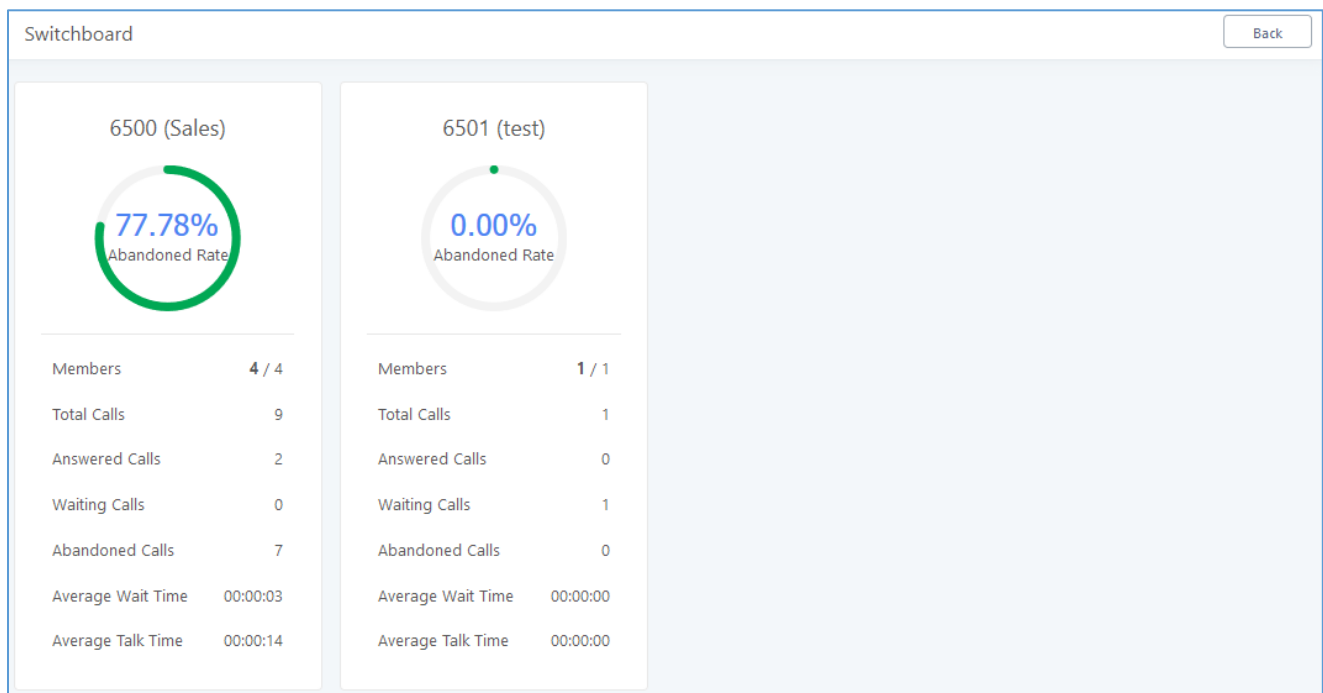
Dynamic Agent Login Settings	
<b>Agent Login Code Suffix</b>	Configure the code to dial after the queue extension to log into the queue (i.e. queue extension + suffix). If no suffix is configured, dynamic agents will not be able to log in
<b>Agent Logout Code Suffix</b>	Configure the code to dial after the queue extension to log out of the queue (i.e. queue extension + suffix). If no suffix is configured, dynamic agents will not be able to log out.



Virtual Queue Callback Key Settings	
<b>Call Back Current Number</b>	Press the feature key configured to set your current number as callback number.
<b>Custom Callback Number</b>	Press the feature key configured to set a custom callback number.
<b>Continue Waiting</b>	Press the feature key configured to continue waiting.

## Switchboard

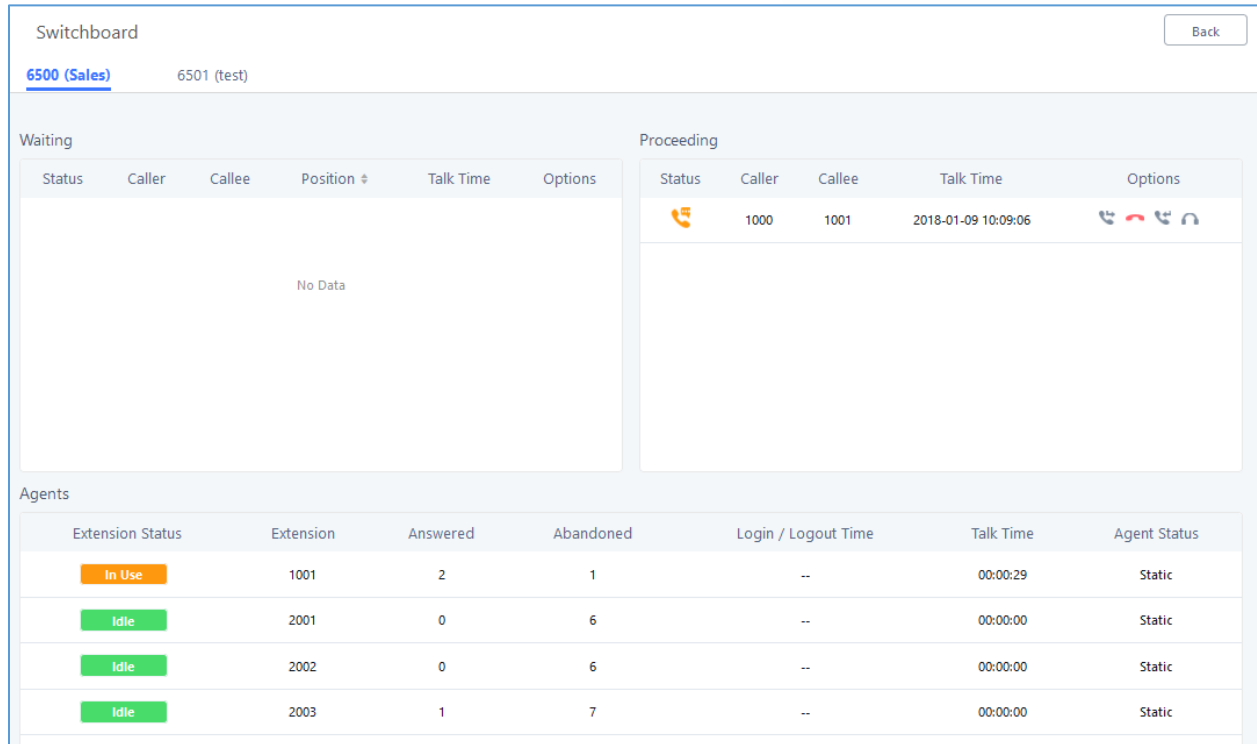
Switchboard is a tool that allows system administrators and users to monitor and manage queues. This can be accessed from the **Call Features** → **Call Queue** page.



**Figure 199 : Switchboard summary**

Clicking on one of the queues shown above will bring up the following window:






**Figure 200: Call Queue Switchboard**

The table below gives a brief description for the main menus:

**Table 96: Switchboard Parameters**

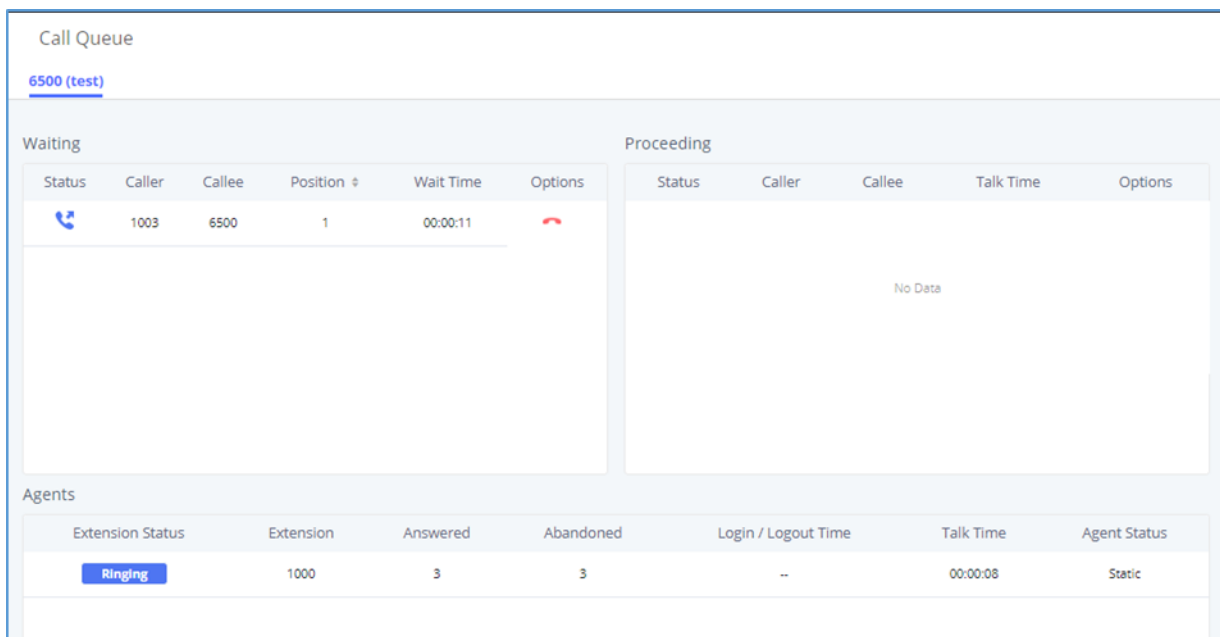
<b>Waiting</b>	This menu shows the current waiting calls along with the caller id and the option to hang-up call by pressing on the  button.
<b>Proceeding</b>	Shows the current established calls along with the caller id and the callee (agent) as well as the option to hang-up, transfer, add conference or barge-in the call.
<b>Agents</b>	<p>Displays the list of agents in the queue and the extension status (idle, ringing, in use or unavailable) along with some basic call statistics and agent's mode (static or dynamic).</p> <p><b>Note:</b> the dashboard will show the number of calls (answered and abandoned) of each agent. For dynamic agents, it will count the number of calls starting from the last login time.</p>

There are three different privilege levels for Call Queue management from the switchboard: Super Admin, Queue Chairman, and Queue Agent.

- **Super Admin** - Default admin of the UCM. Call queue privileges include being able to view and edit all queue agents, monitor and execute actions for incoming and ongoing calls for each extension in Switchboard, and generate Call Queue reports to track performance.



- Queue Chairman** - User appointed by Super Admin to monitor and manage an assigned queue extension via Switchboard. The Queue Chairman can log into the UCM user portal with his extension number and assigned user password. To access the Switchboard, click on “*Value-added Features*” in the side menu and click on “*Call Queue*”. In the image below, User 1012 is the Queue Chairman appointed to manage Queue Extension 6500 and can see all the agents of the queue in the Switchboard.
- Queue Agent** - User appointed by Super Admin to be a member of a queue extension. A queue agent can log into the UCM user portal with his extension number and assigned user password. To access the Switchboard, click on “*Value-added Features*” in the side menu and click on “*Call Queue*”. However, a queue agent can view and manage only his own calls and statistics, but not other agents’ in the queue extension. In the image below, User 1000 is a queue agent and can see only his own information in the Switchboard.



Call Queue

[6500 \(test\)](#)

Waiting						Proceeding				
Status	Caller	Callee	Position #	Wait Time	Options	Status	Caller	Callee	Talk Time	Options
	1003	6500	1	00:00:11		No Data				

Agents							
Extension Status	Extension	Answered	Abandoned	Login / Logout Time	Talk Time	Agent Status	
<b>Ringling</b>	1000	3	3	--	00:00:08	Static	




**Figure 201: Queue Agent**

## PICKUP GROUPS

The UCM6510 supports pickup group feature which allows users to pick up incoming calls for other extensions if they are in the same pickup group, by dialing "Pickup Extension" feature code (by default \*8).

### Configure Pickup Groups

Pickup groups can be configured via Web GUI → **Call Features** → **Pickup Groups**.

- Click on  to create a new pickup group.
- Click on  to edit the pickup group.
- Click on  to delete the pickup group.

Select extensions from the list on the left side to the right side.

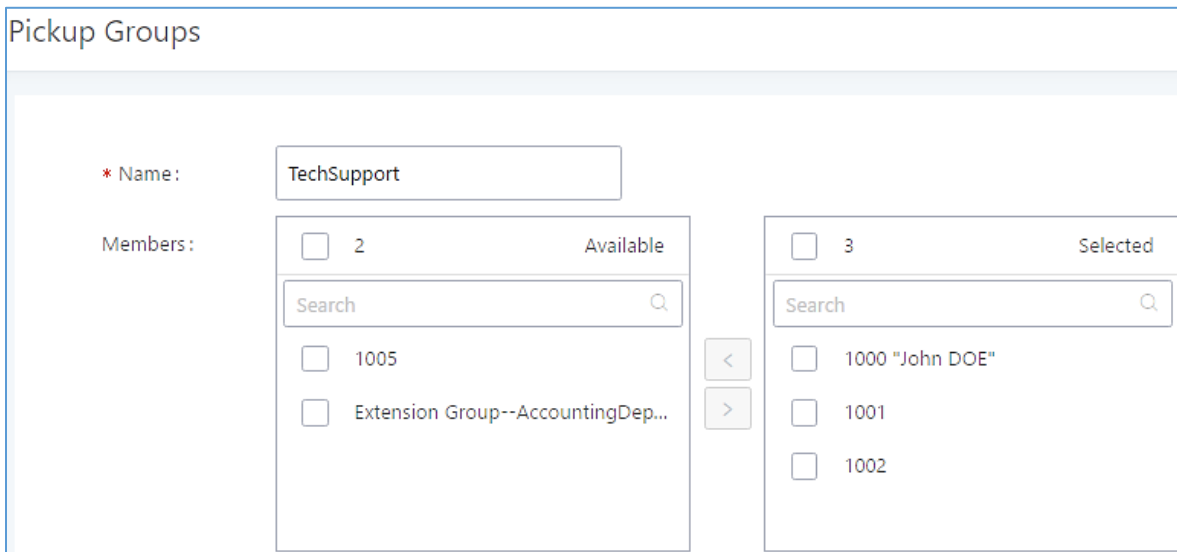


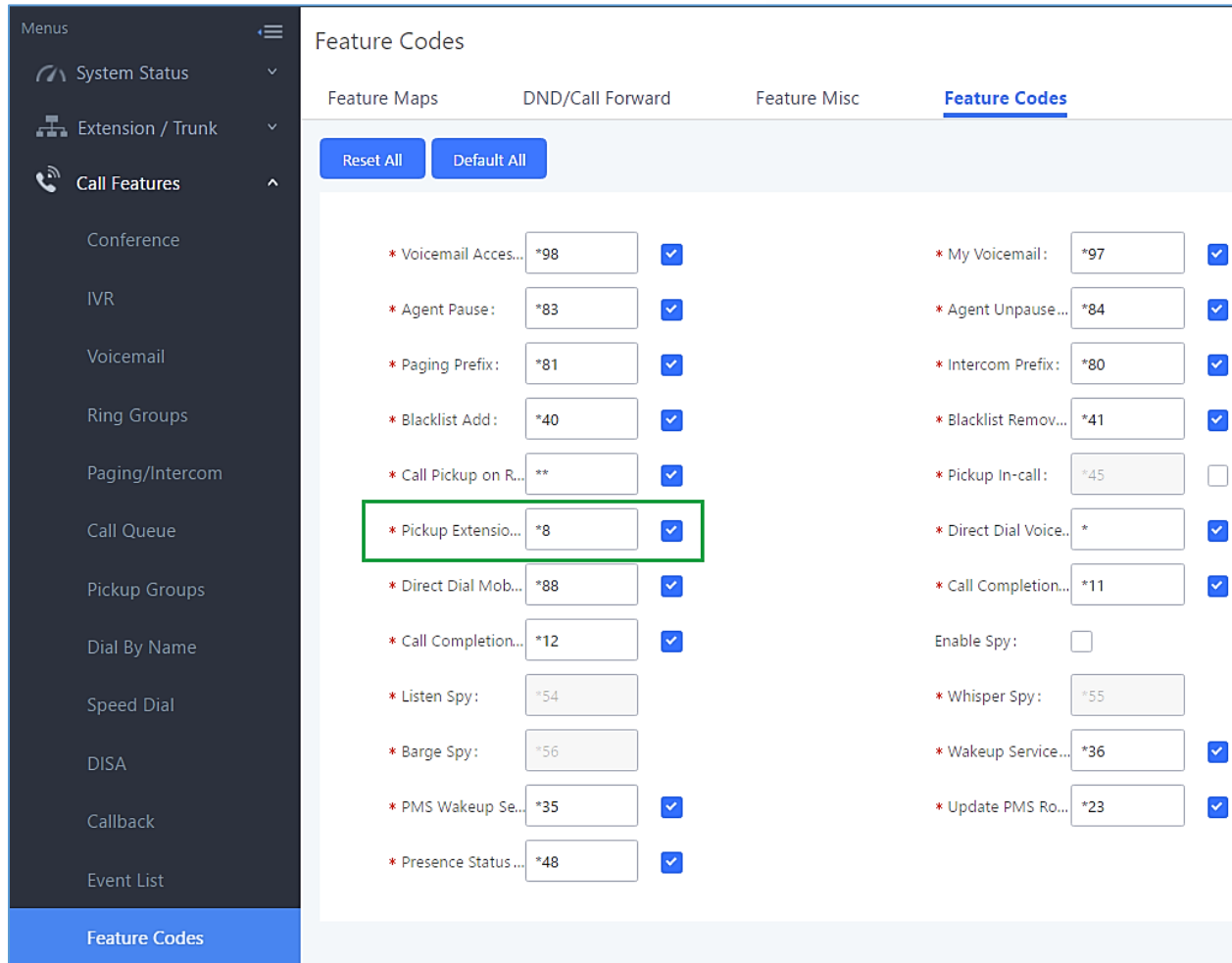
Figure 202: Edit Pickup Group

### Configure Pickup Feature Code

When picking up the call for the pickup group member, the user only needs to dial the pickup feature code. It is not necessary to add the extension number after the pickup feature code. The pickup feature code is configurable under Web GUI → **Call Features** → **Feature Codes**.



The default pickup feature code is \*8 as shown on the following screenshot.



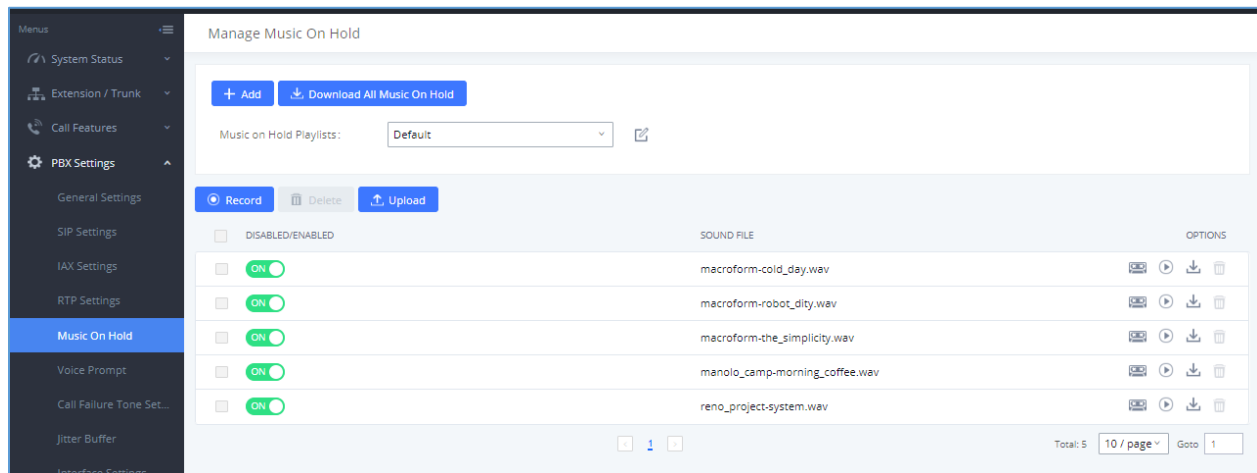
The screenshot shows the 'Feature Codes' configuration page in the Grandstream interface. The left sidebar contains a 'Menus' section with 'Call Features' expanded. The main content area has tabs for 'Feature Maps', 'DND/Call Forward', 'Feature Misc', and 'Feature Codes' (which is selected). Below the tabs are 'Reset All' and 'Default All' buttons. A table of feature codes is displayed, with the 'Pickup Extension' row highlighted by a green box.

Feature Name	Value	Checked
* Voicemail Acces...	*98	<input checked="" type="checkbox"/>
* Agent Pause:	*83	<input checked="" type="checkbox"/>
* Paging Prefix:	*81	<input checked="" type="checkbox"/>
* Blacklist Add:	*40	<input checked="" type="checkbox"/>
* Call Pickup on R...	**	<input checked="" type="checkbox"/>
<b>* Pickup Extensio...</b>	<b>*8</b>	<input checked="" type="checkbox"/>
* Direct Dial Mob...	*88	<input checked="" type="checkbox"/>
* Call Completion...	*12	<input checked="" type="checkbox"/>
* Listen Spy:	*54	<input type="checkbox"/>
* Barge Spy:	*56	<input type="checkbox"/>
* PMS Wakeup Se...	*35	<input checked="" type="checkbox"/>
* Presence Status ...	*48	<input checked="" type="checkbox"/>
* My Voicemail:	*97	<input checked="" type="checkbox"/>
* Agent Unpause...	*84	<input checked="" type="checkbox"/>
* Intercom Prefix:	*80	<input checked="" type="checkbox"/>
* Blacklist Remov...	*41	<input checked="" type="checkbox"/>
* Pickup In-call:	*45	<input type="checkbox"/>
* Direct Dial Voice...	*	<input checked="" type="checkbox"/>
* Call Completion...	*11	<input checked="" type="checkbox"/>
Enable Spy:		<input type="checkbox"/>
* Whisper Spy:	*55	<input type="checkbox"/>
* Wakeup Service...	*36	<input checked="" type="checkbox"/>
* Update PMS Ro...	*23	<input checked="" type="checkbox"/>








**Figure 203: Edit Pickup Feature Code**

## MUSIC ON HOLD

Music On Hold settings can be accessed via Web GUI→**PBX Settings**→**Music On Hold**. In this page, users could configure music on hold playlist and upload music files. The "default" Music On Hold playlist already has 5 audio files defined for users to use.





**Figure 204: Music On Hold Default Playlist**

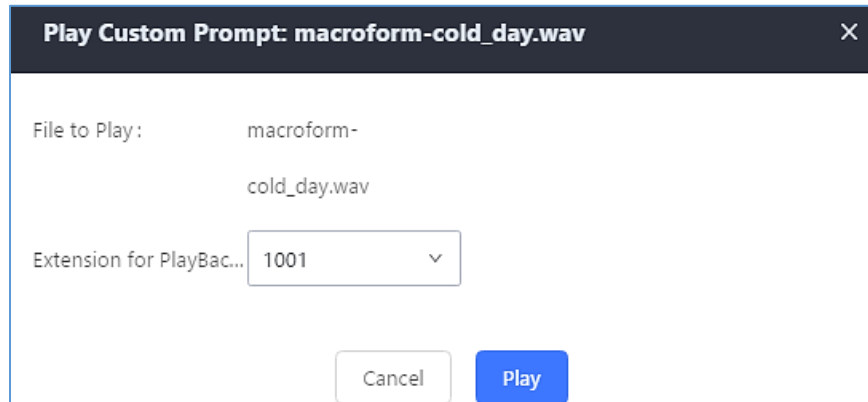
- Click on "Create New MOH Playlist" to add a new Music On Hold playlist.
- Click on  to configure the MOH playlist sort method to be "Name" or "Random" for the sound files.
- Click on  next to the selected Music On Hold playlist to delete this Music On Hold playlist.
- Click on Record to record the Music On Hold.
- Click on  Upload to start uploading. Users can upload:
  - Single files with 8KHz Mono Music file, or
  - Music on hold files in a compressed package with .tar, .tar.gz and .tgz as the suffix. The file name can only be letters, digits or special characters - \_
  - the size for the uploaded file should be less than 30M, the compressed file will be applied to the entire MoH.
- Users could also download all the music on hold files from UCM. In the Music On Hold page, click on  Download All Music On Hold and the file will be downloaded to your local PC.
- Click on  next to the sound file to disable it from the selected Music On Hold Playlist.
- Click on  next to the sound file to enable it from the selected Music On Hold Playlist.
- Select the sound files and click on  Delete Selected Sound Files to delete all selected music on hold files.



The UCM can play selected MOH files to extensions by initiating calls to them from the Manage Music On Hold page.

Steps to play the music on hold file:


1. Click on the  button for the Music on Hold file.
2. In the prompted window, select the extension to playback and click .

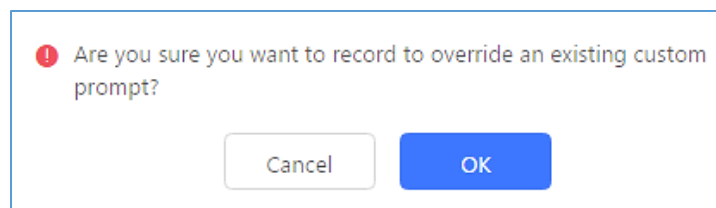


**Figure 205: Play Custom Prompt**

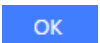

3. The selected extension will ring.
4. Answer the call to listen to the music playback.

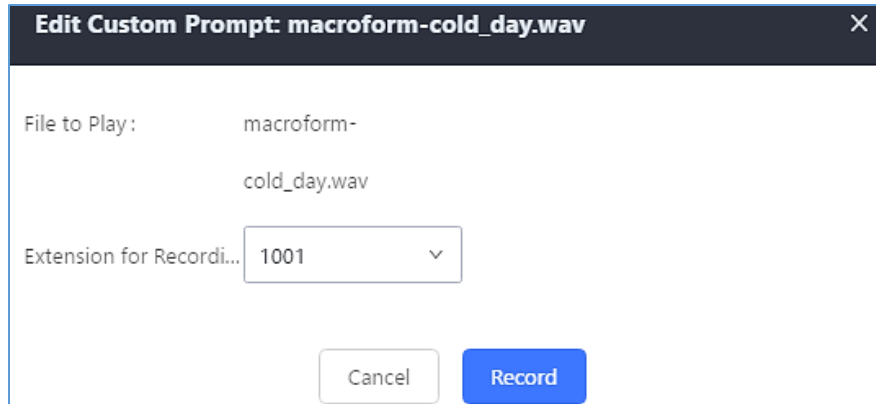
Users could also record their own Music on hold to override an existing custom prompt, this can be done by following those steps:

1. Click on .
2. A prompt of confirmation will pop up, as shown below.



**Figure 206: Information Prompt**

3. Click .
4. In the prompted window, select the extension to playback and click .



**Figure 207: Record Custom Prompt**

5. Answer the call and start to record your new music on hold.
6. Hangup the call and refresh Music On Hold page then you can listen to the new recorded file.

---

 **Note:**

In case the users have deleted the system MOH files, there are two ways to recover.

1. Users could download the MOH file from this link:

<http://downloads.asterisk.org/pub/telephony/sounds/releases/asterisk-moh-opsound-wav-2.03.tar.gz>

After downloading, unzip the pack and upload the music files to the UCM6510.



2. Factory reset could also recover the MOH file on the UCM.
- 



## FAX SERVER

The UCM6510 supports T.30/T.38 Fax and Fax Pass-through. It can also convert the received Fax to PDF format and send it to the configured Email address. Fax/T.38 settings can be accessed via Web GUI→**Call Features**→**Fax/T.38**.

### Configure Fax/T.38

- Click on "Create New Fax Extension". In the popped-up window, fill the extension, name and Email address to send the received Fax to.
- Click on "Fax Settings" to configure the Fax parameters.
- Click on  to edit the Fax extension.
- Click on  to delete the Fax extension.





### Fax Settings

---

\* Enable Error Correction

Mode:

\* Maximum Transfer Rate:

\* Minimum Transfer Rate:

\* Max Concurrent Sending

Fax:

\* Fax Queue Length:

User Information in Fax

Header:

Fax Header Information:

Default Email Address:  [Email Template](#)

Enable Fax Resend:

Max Resend Attempts:

Fax Resend Frequency:

**Figure 208: Fax Settings**

**Table 97: FAX/T.38 Settings**

<b>Enable Error Correction Mode</b>	Configure to enable Error Correction Mode (ECM) for the Fax. The default setting is "Yes".
<b>Maximum Transfer Rate</b>	Configure the maximum transfer rate during the Fax rate negotiation. The possible values are 2400, 4800, 7200, 9600, 12000 and 14400. The default setting is 14400.
<b>Minimum Transfer Rate</b>	Configure the minimum transfer rate during the Fax rate negotiation. The possible values are 2400, 4800, 7200, 9600, 12000 and 14000. The default setting is 2400.



<b>Max Concurrent Sending Fax</b>	Configure the concurrent fax that can be sent by UCM6510. <ul style="list-style-type: none"> <li>• Only mode supports single user fax sending</li> <li>• More mode supports multiple concurrent fax sending</li> </ul> By default, this option is set to "only".
<b>Fax Queue Length</b>	Configure the maximum length of Fax Queue.
<b>User Information in Fax Header</b>	Enable whether to send a special header in SIP fax messages.
<b>Fax Header Information</b>	Adds fax header into the fax file.
<b>Default Email Address</b>	Configure the Email address to send the received Fax to if user's Email address cannot be found. <p><b>Note:</b></p> The extension's Email address or the Fax's default Email address needs to be configured in order to receive Fax from Email. If neither of them is configured, Fax will not be received from Email.
<b>Template Variables</b>	Fill in the "Subject:" and "Message:" content, to be used in the Email when sending the Fax to the users. The template variables are: <ul style="list-style-type: none"> <li>• <b>\${CALLERIDNUM}</b> : Caller ID Number</li> <li>• <b>\${CALLERIDNAME}</b> : Caller ID Name</li> <li>• <b>\${RECEIVEEXTEN}</b> : The extension to receive the Fax</li> <li>• <b>\${FAXPAGES}</b> : Number of pages in the Fax</li> <li>• <b>\${VM_DATE}</b> : The date and time when the Fax is received</li> </ul>
<b>Enable Fax Resend</b>	Enables the fax resend option which allow the UCM to keep attempting to send faxes up to a specified amount of times. Additionally, if a fax still fails to send, a <i>Resend</i> button will appear in the File Send Progress list in <i>Value-Added Features</i> → <i>Fax Sending</i> to allow manual resending.
<b>Max Resend Attempts</b>	Configures the maximum attempts number to resend the fax.

## Receiving FAX

### Example Configuration to Receive Fax from PSTN Line

The following instructions describe how to use the UCM6510 to receive fax from PSTN line on the Fax machine connected to the UCM6510 FXS port.

1. Connect Fax machine to the UCM6510 FXS port.
2. Connect PSTN line to the UCM6510 FXO port.



3. Go to Web GUI→**Extension/Trunk** page.
4. Create or edit the analog trunk for Fax as below.  
**Fax Detection:** Make sure "Fax Detection" option is set to "No".

Edit Analog Trunk: Telco1
Save

FXO Port:  1  2

\* Trunk Name:  SLA Mode:

**Advanced Options**

Enable Polarity Rev...

Current Disconnec...   \* Ring Timeout:

\* RX Gain:  \* TX Gain:

Use CallerID:  **Fax Mode:** None ▼

Caller ID Scheme:  \* FXO Dial Delay (...):

**Figure 209: Configure Analog Trunk without Fax Detection**

5. Go to UCM6510 Web GUI→**Extension/Trunk**→**Extensions** page.
6. Create or edit the extension for FXS port.
  - **Analog Station:** Select FXS port to be assigned to the extension. By default, it is set to "None".
  - Once selected, analog related settings for this extension will show up in "**Analog Settings**" section.



Create New Extension Save

Basic Settings   Media   Features   Specific Time   Follow Me

\* Select Extension Type:  ▼

Select Add Method:  ▼

---

General

\* Extension:       Analog Station:  ▼

CallerID Number:

\* Permission:  ▼

Enable Voicemail:

\* Voicemail Password:

Skip Voicemail Passwo...       Disable This Extension ...

**Figure 210: Configure Extension For Fax Machine**

Create New Extension Save

Basic Settings   **Media**   Features   Specific Time   Follow Me

Analog Settings

Call Waiting:

Use "#" as SEND:

\* RX Gain:       \* TX Gain:

\* MIN RX Flash:       \* MAX RX Flash:

Enable Polarity Reversal:       \* Echo Cancellation:  ▼

3-way Calling:       \* Send CallerID After:  ▼

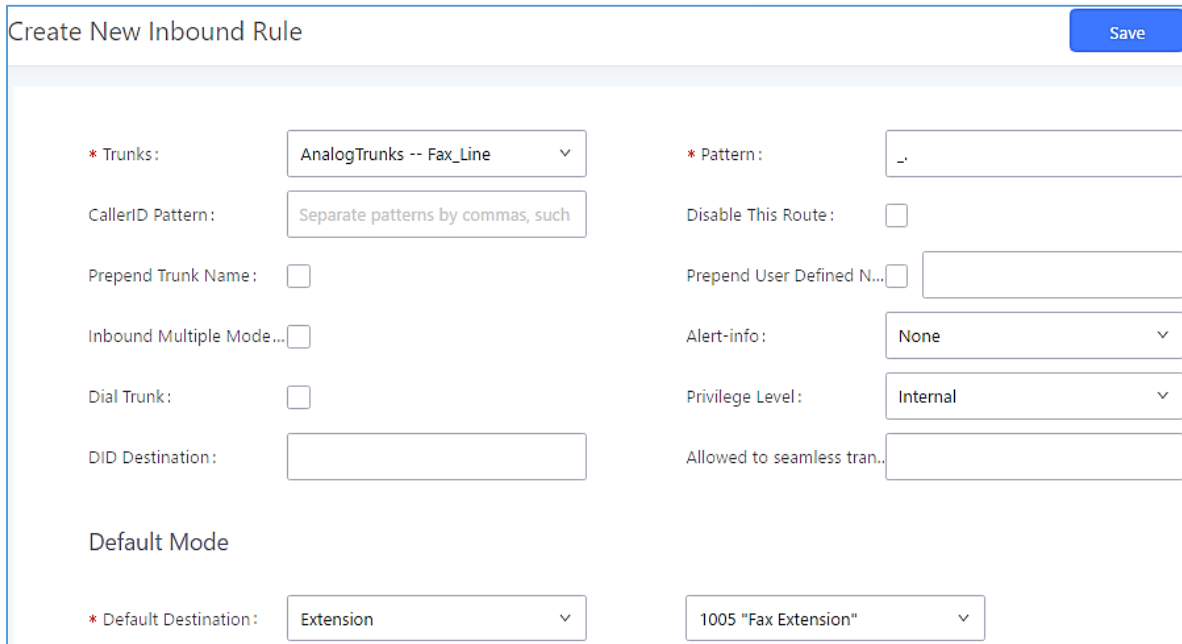
\* Fax Mode:  ^

- None
- Fax Detection
- Fax Gateway**

**Figure 211: Configure Extension for Fax Machine: Analog Settings**

7. Go to Web GUI→**Extension/Trunk**→**Inbound Routes** page.
8. Create an inbound route to use the Fax analog trunk. Select the created extension for Fax machine in step 4 as the default destination.





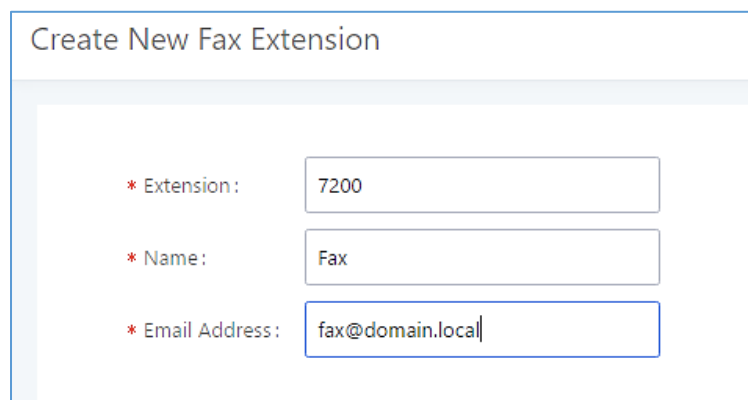
**Figure 212: Configure Inbound Rule for Fax**

Now the Fax configuration is done. When there is an incoming Fax calling to the PSTN number for the FXO port, it will send the Fax to the Fax machine.

### Example Configuration for Fax-To-Email

The following instructions describe a sample configuration on how to use Fax-to-Email feature on the UCM6510.

1. Connect PSTN line to the UCM6510 FXO port.
2. Go to UCM6510 Web GUI→**Internal Options**→**Fax/T.38** page. Create a new Fax extension.

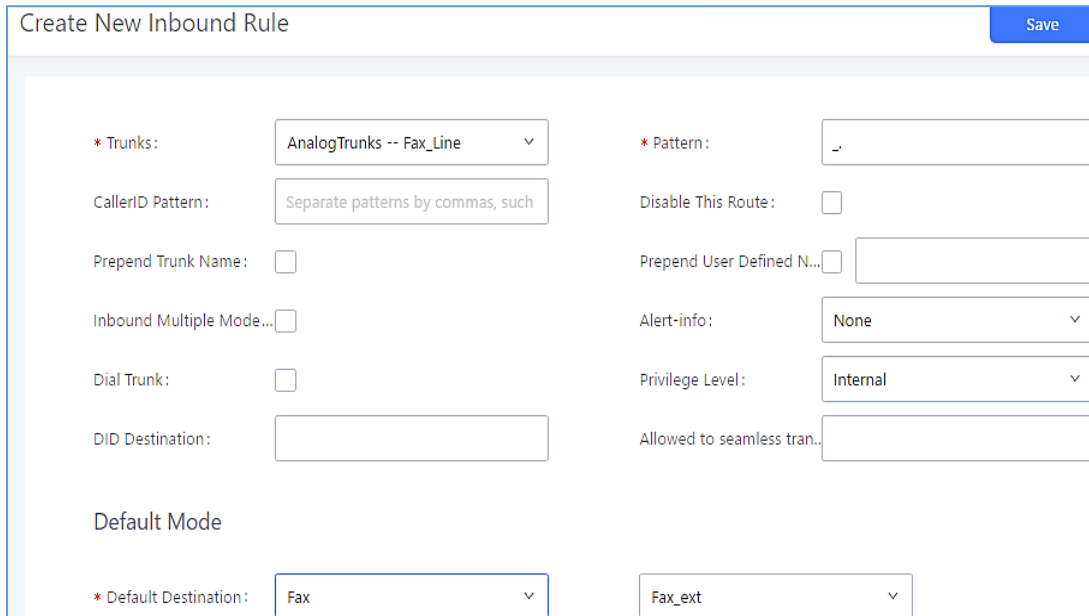


**Figure 213: Create Fax Extension**

3. Go to UCM6510 Web GUI→**Extension/Trunk**→**Analog Trunks** page. Create a new analog trunk with "FAX Detection" set to "No".



- Go to UCM6510 Web GUI→**Extension/Trunk**→**Inbound Routes** page. Create a new inbound route and set the default destination to the Fax extension.



**Figure 214: Inbound Route to Fax Extension**

- Once successfully configured, the incoming Fax from external Fax machine to the PSTN line number will be converted to PDF file and sent to the Email address **fax@domain.local** as attachment.

## Fax Sending

The UCM6510 supports sending Fax via Web GUI access. This feature can be found on Web GUI→**Value-added Features**→**Fax Sending** page. In order to send fax, pre-setup for analog trunk and outbound route is required.

**Note:** Only A3, A4 and B4 paper sizes are supported for the Fax Sending.

After making sure analog trunk or VoIP Trunk is setup properly and UCM6510 can reach out to PSTN numbers via the trunk, on Fax Sending page, enter the fax number and upload the file to be faxed. Then click on “Send” to start. The progress of sending fax will be displayed in Web GUI. Users can also view the sending history is in the same web page.



### Fax Sending

\* External Fax Number:

Fax File:

---

### File Send Progress

**Figure 215: Fax Sending in Web GUI**



## BUSY CAMP-ON

The UCM6510 supports busy camp-on/call completion feature that allows the PBX to camp on a called party and inform the caller as soon as the called party becomes available given the previous attempted call has failed.

The configuration and instructions on how to use busy camp-on/call completion feature can be found in the following guide:

[http://www.grandstream.com/sites/default/files/Resources/ucm6xxx\\_busy\\_camp\\_on\\_guide.pdf](http://www.grandstream.com/sites/default/files/Resources/ucm6xxx_busy_camp_on_guide.pdf)





## PRESENCE

UCM supports SIP presence, allowing extensions to advertise their current availability for calls. This presence can be monitored by other users.

Presence is different from BLF in that SIP presence is a status that users can manually set themselves.

Users can change presence status from the webUI:

- Admin Portal: Navigate to **Extension/Trunk**→**Extensions**→**Edit Extension**→**Features** and click on the Presence Status dropdown list.
- User Portal: Navigate to **Basic Information**→**Extensions**→**Features** and click on the Presence Status dropdown list.

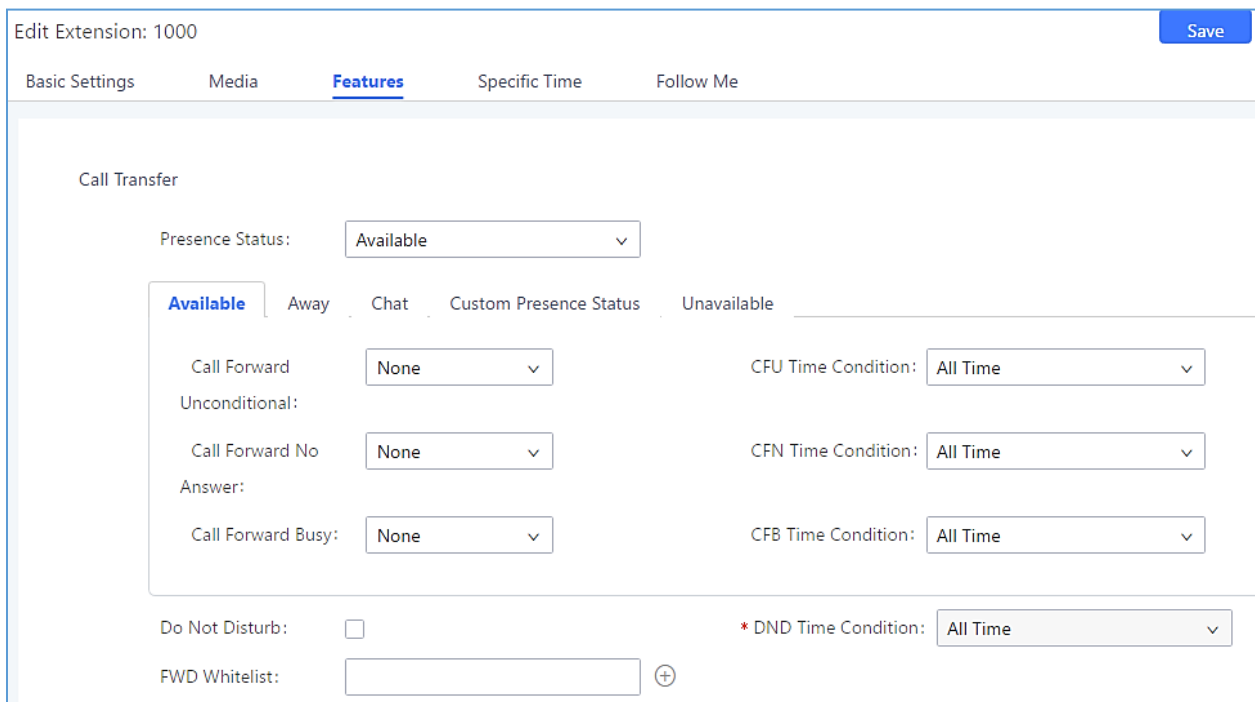


Figure 216 shows the 'Edit Extension: 1000' configuration page, specifically the 'Features' tab. The 'Call Transfer' section is visible, with the 'Presence Status' dropdown set to 'Available'. Below this, there are tabs for 'Available', 'Away', 'Chat', 'Custom Presence Status', and 'Unavailable'. The 'Available' tab is selected, showing settings for 'Call Forward Unconditional', 'Call Forward No Answer', and 'Call Forward Busy', each with a 'None' dropdown and a corresponding 'Time Condition' dropdown set to 'All Time'. There is also a 'Do Not Disturb' checkbox (unchecked) and a 'DND Time Condition' dropdown set to 'All Time'. A 'FWD Whitelist' field is at the bottom with a plus icon.

**Figure 216: SIP Presence Configuration**

Select which status to set from the presence status selection drop list. The following options are available:

**Table 98: SIP Presence Status**

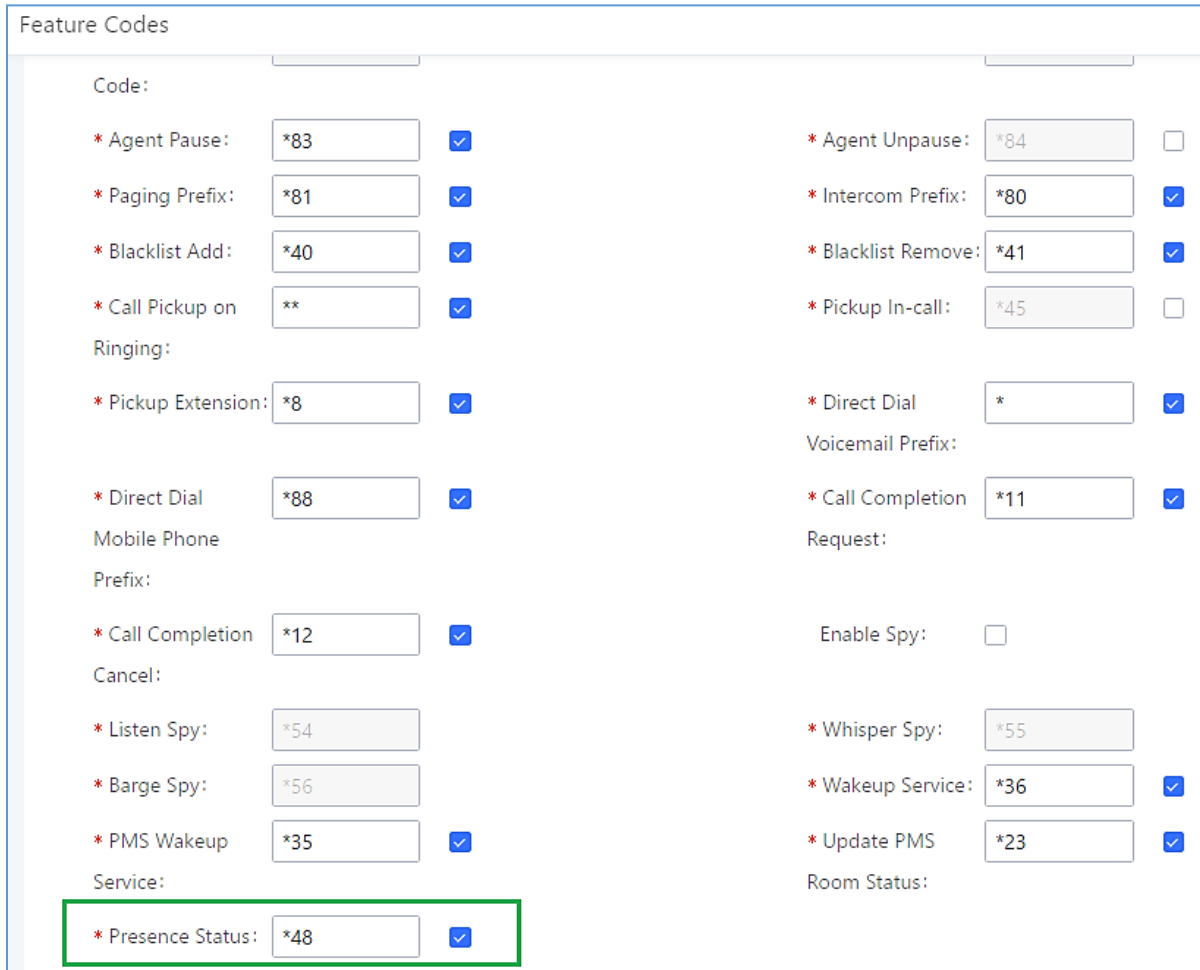
<b>Available</b>	The contact is online and can participate in conversations/phone calls.
<b>Away</b>	The contact is currently away (ex: for lunch break).
<b>Chat</b>	The contact has limited conversation flexibility and can only be reached via chat.
<b>Do Not Disturb</b>	The Contact is on DND (Do Not Disturb) mode.



<b>Custom Presence Status</b>	Please enter the presence status for this mode on the Web GUI. Up to 64 characters.
<b>Unavailable</b>	The contact is unreachable for the moment, please try to contact later.

Users can also set presence status by dialing the feature code from their phones (\*48 by default). The prompt will ask users what presence status they want to set.

The feature code can be enabled/customized from the Web GUI → **Call Features** → **Feature Codes**.



Feature Codes	
Code:	
* Agent Pause:	*83 <input checked="" type="checkbox"/>
* Agent Unpause:	*84 <input type="checkbox"/>
* Paging Prefix:	*81 <input checked="" type="checkbox"/>
* Intercom Prefix:	*80 <input checked="" type="checkbox"/>
* Blacklist Add:	*40 <input checked="" type="checkbox"/>
* Blacklist Remove:	*41 <input checked="" type="checkbox"/>
* Call Pickup on Ringing:	** <input checked="" type="checkbox"/>
* Pickup In-call:	*45 <input type="checkbox"/>
* Pickup Extension:	*8 <input checked="" type="checkbox"/>
* Direct Dial:	* <input checked="" type="checkbox"/>
* Direct Dial:	*88 <input checked="" type="checkbox"/>
Voicemail Prefix:	
* Call Completion:	*11 <input checked="" type="checkbox"/>
Mobile Phone Prefix:	
* Call Completion:	*12 <input checked="" type="checkbox"/>
Request:	
Enable Spy:	<input type="checkbox"/>
* Listen Spy:	*54
* Whisper Spy:	*55
* Barge Spy:	*56
* Wakeup Service:	*36 <input checked="" type="checkbox"/>
* PMS Wakeup:	*35 <input checked="" type="checkbox"/>
* Update PMS:	*23 <input checked="" type="checkbox"/>
Room Status:	
* Presence Status:	*48 <input checked="" type="checkbox"/>

**Figure 217: SIP Presence Feature Code**







When a user does change his/her SIP presence status by making a call using presence feature code, the UCM will create a corresponding CDR entry showing the call as **Action type = PRSENCE\_STATUS**.



CDR Filter

By default, this page displays the CDR entries from the current month. Use the "Filter" button to specify a time range.

Delete All
Delete Search Result (s)
Download All Records
Download Search Result (s)
Automatic Download

Status	Call from	Call to	Action Type	Start Time	Call Time	Talk Time	Account Code	Recording File Options
+ 	"4004" 4004	*48	PRESENCE_STATUS	2018-01-30 05:53:02	0:00:30	0:00:30		-
+ 	"4002" 4002	4001	DIAL	2018-01-29 06:18:43	0:00:03	0:00:00		-
+ 	0622667315 [Trunk: GXP2160]	4001	DIAL	2018-01-29 06:13:01	0:00:14	0:00:03		-
+ 	"4001" 4001	5475 [Trunk: GXP2160]	DIAL	2018-01-29 04:47:13	0:00:05	0:00:04		-
+ 	"4001" 4001	65465476 [Trunk: GXP2160]	DIAL	2018-01-29 04:46:25	0:00:01	0:00:00		-
+ 	"4001" 4001	9	DIAL	2018-01-29 04:46:21	0:00:02	0:00:00		-

Total: 6 < 1 > 10 / page Goto 1


**Figure 218: Presence Status CDR**



## FOLLOW ME

UCM supports Follow Me feature which allows users to direct calls to other phone numbers and have them ring all at once or one after the other. Calls can be directed to users' home phone, office phone, mobile and etc. The calls will get to the user no matter where they are. Follow Me option can be found under extension settings page Web GUI→**Extension/Trunk**→**Extensions**.

To configure follow me:

1. Choose the extension and click on .
2. Go to the Follow me tab to add destination numbers and enable the feature.

Edit Extension: 1000
Save

Basic Settings
Media
Features
Specific Time
Follow Me

Enable:

Music On Hold Class:

Enable Destination:

Default Destination:

Skip Trunk Auth:

Confirm When Answering:

**Follow Me Numbers**

New Follow Me Number:  Dial Local Extension  Dial External Number



for  (seconds)

Dialing Order:  Ring after trying previous extension/number  Ring along with previous extension/number

+ Add

1002 for 30 (seconds)	<span style="color: red; font-weight: bold;">×</span>
1003 for 30 (seconds)	<span style="color: red; font-weight: bold;">×</span>





**Figure 219: Edit Follow Me**

3. Click on “Add Follow Me Number” to add local extensions or external numbers to be called after ringing the extension selected in the first step.
4. Once created, it will be displayed on the follow me web page list. Click on  to edit the Follow Me configuration. Click on  to delete the Follow Me.



The following table shows the Follow Me configuration parameters.

**Table 99: Follow Me Settings**

<b>Enable</b>	Configure to enable or disable Follow Me for this user.
<b>Skip Trunk Auth</b>	If external number is added in the Follow Me, please make sure this option is enabled or the “Skip Trunk Auth” option of the extension is enabled, otherwise the external Follow Me number cannot be reached.
<b>Music On Hold Playlist</b>	Configure the Music On Hold playlist that the caller would hear while tracking the user.
<b>Confirm When Answering</b>	By default, it is enabled, and user will be asked to press 1 to accept the call or to press 2 to reject the call after answering a Follow Me call. If it is disabled, the Follow Me call will be established once after the user answers it.
<b>Enable Destination</b>	If enabled, the call will be routed to the default destination if no one in the Follow Me answers the call.
<b>Default Destination</b>	Configure the destination if no one in the Follow Me answers the call, available options are: <ul style="list-style-type: none"> <li>• Extension</li> <li>• Voicemail</li> <li>• Queues</li> <li>• Ring Group</li> <li>• Voicemail Group</li> <li>• IVR</li> <li>• External Number</li> </ul>
<b>Follow Me Numbers</b>	The added numbers are listed here. Click on   to arrange the order. Click on  to delete the number. Click on  to add new numbers.
<b>New Follow Me Number</b>	Add a new Follow Me number which could be a ‘Local Extension’ or ‘External Number’. The selected dial plan should have permissions to dial the defined external number.
<b>Dialing Order</b>	Select the order in which the Follow Me destinations will be dialed to reach the user: ring all at once or ring one after the other.

Click on “Follow Me Options” under Web GUI→**Extension/Trunk**→**Extension** page to enable or disable the options listed in the following table.



**Table 100: Follow Me Options**

<b>Playback Incoming Status Message</b>	If enabled, the PBX will playback the incoming status message before starting the Follow Me steps.
<b>Record the Caller's Name</b>	If enabled, the PBX will record the caller's name from the phone, so it can be announced to the callee in each step.
<b>Playback Unreachable Status Message</b>	If enabled, the PBX will playback the unreachable status message to the caller if the callee cannot be reached.



## SPEED DIAL

The UCM6510 supports Speed Dial feature that allows users to call specified destinations by pressing only 1-4 digits. This creates a system-wide speed dial access for all the extensions on the UCM6510.

To enable Speed Dial, on the UCM6510 Web GUI, go to page Web GUI→**Call Features**→**Speed Dial**.

User should first click on + Add. Create a speed dial extension and assign a destination to it. Supported destinations are Extension, Conference Room, Video Conference Room, Voicemail, Voicemail Group, IVR, Ring Group, Queue, Paging/Intercom Group, Fax, DISA, Dial by Name, Announcement, and External Number.

### Create New Speed Dial

Enable

Destination:

\* Speed Dial

Extension:

Default Extension ▾ 1007 ▾

Destination:

**Figure 220: Speed Dial Destinations**

Speed Dial					
<span style="float: left; background-color: #0070C0; color: white; padding: 2px 5px; border-radius: 3px; margin-right: 10px;">+ Add</span>					
Extension ↕	Speed Dial	Default Destination	Default Destination	Options	
1	Enable	Extension	1000		
2	Enable	Extension	1001		
3	Enable	External Number	0016175669300		
4	Enable	Ring Group	6400		
5	Enable	Queues	6500		

Total: 5 < 1 > 10 / page ▾ Goto 1



**Figure 221: List of Speed Dial**



## DISA

In many situations, the user will find the need to access his own IPPBX resources, but he is not physically close to any one of his extensions. However, he does have access to his own cell phone. In this case, we can use what is commonly known as DISA (Direct Inward System Access). Under this scenario, the user will be able to call from the outside first, whether it's using his cell phone, pay phone, regular PSTN and etc, and then call into a SIP trunk or PSTN trunk connected to UCM6510 as it is an internal extension.

The UCM6510 supports DISA to be used in IVR or inbound route. Before using it, create new DISA under Web GUI→**Call Features**→**DISA**.

- Click on "Create New DISA" to add a new DISA.
- Click on  to edit the DISA configuration.
- Click on  to delete the DISA.

### Create New DISA

\* Name:

\* Password:

Permission:  ▾

\* Response Timeout...:

\* Digit Timeout:

Allow Hang-up:

Replace Display Nam...:

**Figure 222: Create New DISA**

**Table 101: DISA Settings**

<b>Name</b>	Configure DISA name to identify the DISA.
<b>Password</b>	Configure the password (digit only) required for the user to enter before using DISA to dial out. <b>Note:</b> The password has to be at least 4 digits.





<b>Permission</b>	Configure the permission level for DISA. The available permissions are "Internal", "Local", "National" and "International" from the lowest level to the highest level. The default setting is "Internal". If the user tries to dial outbound calls after dialing into the DISA, the UCM6510 will compare the DISA's permission level with the outbound route's privilege level. If the DISA's permission level is higher than (or equal to) the outbound route's privilege level, the call will be allowed to go through.
<b>Response Timeout</b>	Configure the maximum amount of time the UCM6510 will wait before hanging up if the user dials an incomplete or invalid number. The default setting is 10 seconds.
<b>Digit Timeout</b>	Configure the maximum amount of time permitted between digits when the user is typing the extension. The default setting is 5 seconds.
<b>Allow Hangup</b>	If enabled, during an active call, users can enter the UCM6510 Hangup feature code (*0 by default) to disconnect the call or hang up directly. A new dial tone will be heard shortly for the user to make a new call. The default setting is "No".
<b>Replace Display Name</b>	If enabled, the UCM will replace the caller display name with the DISA name.

Once successfully created, users can configure the inbound route destination as "DISA" or IVR key event as "DISA". When dialing into DISA, users will be prompted with password first. After entering the correct password, a second dial tone will be heard for the users to dial out.



## EMERGENCY

UCM supports configuration and management of numbers to be called in emergency, thus bypassing the regular outbound call routing process and allowing users in critical situation to dial out for emergency help with the possibility to have redundant trunks as point of exit in case one of the lines is down.


UCM6xxx series are also now in full compliance with Kari's Law and Ray Baum's Act, for more information, please refer to the following links:

<https://www.fcc.gov/mlts-911-requirements>

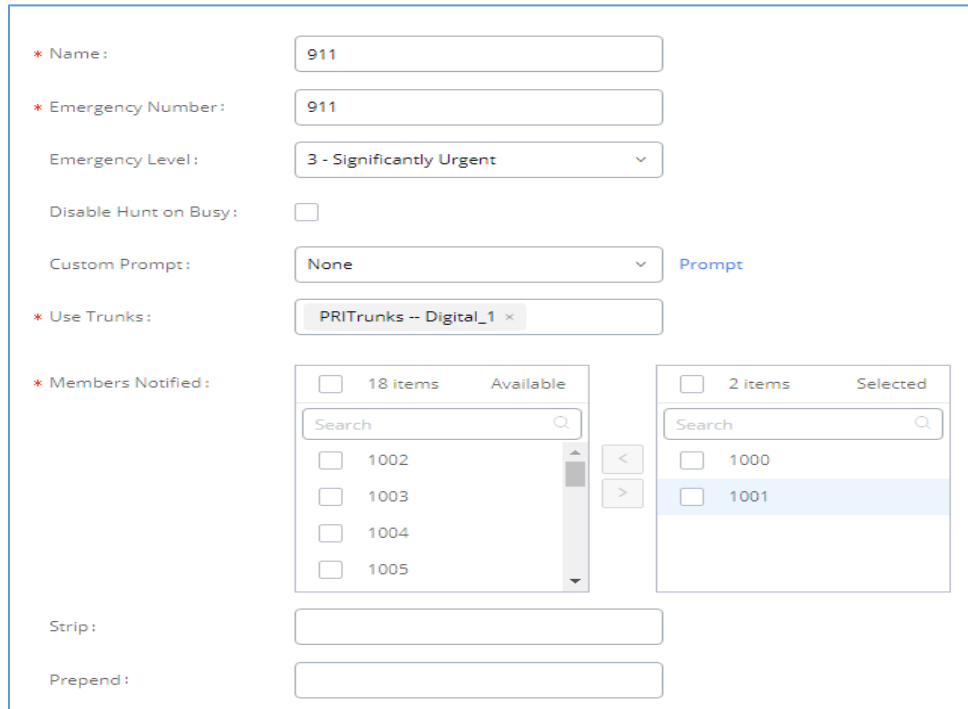
[http://www.grandstream.com/sites/default/files/Resources/UCM\\_Emergency\\_Calls\\_Guide.pdf](http://www.grandstream.com/sites/default/files/Resources/UCM_Emergency_Calls_Guide.pdf)

In addition, Emergency calls can be automatically recorded by toggling on the new Auto Record and recordings can be viewed in the new Emergency Recordings tab on the same page. Additionally, users can have these recordings be sent to the configured email address(es). Email alerts are also supported after enabling the notification for the event under "**Maintenance → System Events**"

To configure emergency numbers, users need to follow below steps:

1. Navigate on the web GUI under "**Call Features → Emergency Calls**"
2. Click on  to add a new emergency number.
3. Configure the required fields "Name, Emergency Number and Trunk(s) to be used to reach the number".
4. Save and apply the configuration.





The screenshot shows a configuration form for an emergency number. The fields are as follows:

- Name:** 911
- Emergency Number:** 911
- Emergency Level:** 3 - Significantly Urgent
- Disable Hunt on Busy:**
- Custom Prompt:** None
- Use Trunks:** PRITrunks -- Digital\_1
- Members Notified:** A list of 18 items is available, with 2 items selected (1000 and 1001).
- Strip:** (empty field)
- Prepend:** (empty field)

**Figure 223: Emergency Number Configuration**

The table below gives more description of the configuration parameters when creating emergency numbers.

**Table 102: Emergency Numbers Parameters**







<b>Name</b>	Configure the name of the emergency call. For example, "emergency911", "emergency211" and etc.
<b>Emergency Number</b>	Config the emergency service number. For example, "911", "211" and etc.
<b>Emergency Level</b>	Select the emergency level of the number. Level "3" means the most urgent.
<b>Disable Hunt on Busy</b>	If this option is not enabled, when the lines of trunks which the coming emergency call routes by are completely occupied, the line-grabbing function will automatically cut off a line from all busy lines so that the coming emergency call can seize it for dialing out. This option is not enabled by default.
<b>Custom Prompt</b>	Configures a custom prompt that will be played to the notified extensions when an emergency call is made. The file can be uploaded from the page "Custom Prompt". Click "Upload Audio File" to add a custom prompt.



<b>Use Trunks</b>	Select the trunks for the emergency call. Up to five trunks can be selected.
<b>Members Notified</b>	Select the members who will be notified when an emergency call occurs.
<b>Strip</b>	Specify the number of digits that will be stripped from the beginning of the dialed number before the call is placed via the selected trunk. <b>Note:</b> Users can strip the same amount of numbers as the emergency number length itself.
<b>Prepend</b>	Specify the digits to be prepended before the call is placed via the trunk. Those digits will be prepended after the dialing number is stripped.
<b>Auto Record</b>	If enabled, the calls using this extension or trunk will be automatically recorded. The Recordings can be viewed in the new Emergency Recordings tab on the same page.
<b>Send Recording File</b>	If enabled, the recordings will be sent to the configured email address(es).
<b>Email Address</b>	Configure the email addresses that will receive emergency call notifications.

Emergency Calls

[Emergency Calls](#)    [Emergency Recordings](#)    [Emergency Location Mapping](#)

[+ Add](#)

NAME	EMERGENCY NUMBER	EMERGENCY LEVEL	DISABLE HUNT ON BUSY	OPTIONS
911	911	3	No	 
811	811	2	No	 
711	711	1	No	 

 1 

Total: 3    10 / page    Goto: 1

**Figure 224: 911 Emergency Sample**

## CALLBACK

Callback is designed for users who often use their mobile phones to make long distance or international calls which may have high service charges. The callback feature provides an economic solution for reduce the cost from this.

The callback feature works as follows:

1. Configure a new callback on the UCM6510.
2. On the UCM6510, configure destination of the inbound route for analog trunk to callback.
3. Save and apply the settings.
4. The user calls the PSTN number of the UCM6510 using the mobile phone, which goes to callback destination as specified in the inbound route.
5. Once the user hears the ringback tone from the mobile phone, hang up the call on the mobile phone.
6. The UCM6510 will call back the user.
7. The user answers the call.
8. The call will be sent to DISA or IVR which directs the user to dial the destination number.
9. The user will be connected to the destination number.

In this way, the calls are placed and connected through trunks on the UCM6510 instead of to the mobile phone directly. Therefore, the user will not be charged on mobile phone services for long distance or international calls.

To configure callback on the UCM6510, go to Web GUI→**Call Features**→**Callback** page and click on

[+ Create New Callback](#)

. Configuration parameters are listed in the following table.

**Table 103: Callback Configuration Parameters**

<b>Name</b>	Configure a name to identify the Callback. (Enter at least two characters)
<b>CallerID Pattern</b>	Configure the pattern of the callers allowed to use this callback. The caller who places the inbound call needs to have the CallerID match this pattern so that the caller can get callback after hanging up the call. <b>Note:</b> If leaving as blank, all numbers are allowed to use this callback.



<b>Outbound Prepend</b>	Configure the prepend digits to be added at before dialing the outside number. The number with prepended digits will be used to match the outbound route. '-' is the connection character which will be ignored.
<b>Delay Before Callback</b>	Configure the number of seconds to be delayed before calling back the user.
<b>Destination</b>	Configure the destination which the callback will direct the caller to. Two destinations are available: <ul style="list-style-type: none"><li>• IVR</li><li>• DISA</li></ul> The caller can then enter the desired number to dial out via UCM6510.



## BLF AND EVENT LIST

### BLF

The UCM6510 supports BLF monitoring for extensions, ring group, call queue, conference room and parking lot. For example, on the user's phone, configure the parking lot number 701 as the BLF monitored number. When there is a parked call on 701, the LED for this BLF key will light up in red, meaning a call is parked against this parking lot. Pressing this BLF key can pick up the call from this parking lot.

---



 **Note:**

- On the Grandstream GXP phones, the MPK supports "Call Park" mode, which is normally used to park the call by configuring the MPK number as call park feature code (e.g., 700). Users could also use "Call Park" mode to monitor and pick up the call on this parking lot by configuring the MPK number as parking lot number (e.g., 701).

---

### Event List

Besides BLF, users can also configure the phones to monitor event list. By using event list, local extensions on the same UCM6510 or remote extensions on the VOIP trunk can be monitored. The event list settings are under Web GUI→**Call Features**→**Event List**.

- Click on "Create New Event List" to add a new event list.
- Sort selected extensions manually in the Eventlist.
- Click on  to edit the event list configuration.
- Click on  to delete the event list.



### Create New Event List

---

**\* URI:**

**Event Type:**

**Local Extensions:**

4/5 items Available

Search here

- 1000 "John DOE"
- 1001
- 1002
- 1003
- 1004

0 item Selected

Search here

None

**Remote Extensions:**

0 item Available

Search here

None

0 item Selected

Search here

None

**Special Extensions:**

**Figure 225: Create New Event List**

**Table 104: Event List Settings**

<b>URI</b>	Configure the name of this event list (for example, office_event_list). Please note the URI name cannot be the same as the extension name on the UCM6510. The valid characters are letters, digits, _ and -.
<b>Local Extensions</b>	Select the available extensions listed on the local UCM6510 to be monitored in the event list.
<b>Remote Extensions</b>	If LDAP sync is enabled between the UCM6510 and the peer UCM6510, the remote extensions will be listed under "Available Extensions". If not, manually enter the remote extensions under "Special Extensions" field.



**Special Extensions**

Manually enter the remote extensions in the peer/register trunk to be monitored in the event list.

Valid format: 5000,5001,9000

Event List BLF can be used to monitor remote LDAP extensions on VoIP trunks. SIP endpoints will need to support event list BBLF to monitor remote extensions.

When an event list is created on the UCM and remote extensions are added to the list, the UCM will send out SIP SUBSCRIBE to the remote UCM to obtain the remote extension status. When the SIP end points register and subscribe to the local UCM event list, it can obtain the remote extension status from this event list.

Once successfully configured, the event list page will show the status of total extension and subscribers for each event list. Users can also select the event URI to check the monitored extension's status and the subscribers' details.

**Notes:**

- To configure LDAP sync, please go to UCM6510 Web GUI→**Extension/Trunk**→**VoIP Trunk**. You will see "Sync LDAP Enable" option. Once enabled, please configure password information for the remote peer UCM6510 to connect to the local UCM6510. Additional information such as port number, LDAP outbound rule, LDAP Dialed Prefix will also be required. Both the local UCM6510 and remote UCM6510 need enable LDAP sync option with the same password for successful connection and synchronization.
  - Currently LDAP sync feature only works between two UCMs.
  - (Theoretically) Remote BLF monitoring will work when the remote PBX being monitored is non-UCM6510 PBX. However, it might not work the other way around depending on whether the non-UCM6510 PBX supports event list BLF or remote monitoring feature.
- 

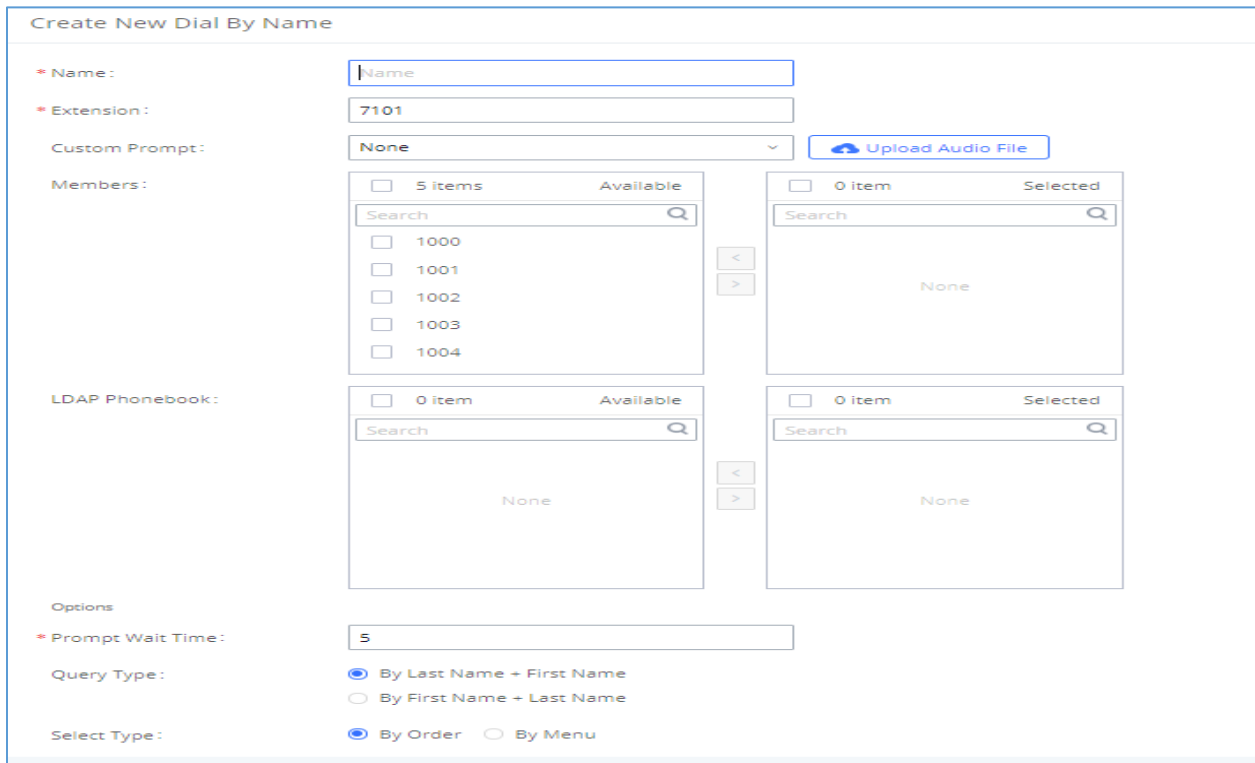


## DIAL BY NAME

Dial By Name is a feature on the PBX that allows caller to search a person by first or last name via his/her phone's keypad. The administrator can define the Dial By Name directory including the desired extensions in the directory and the searching type by "first name" or "last name". After dialing in, the PBX IVR/Auto Attendant will guide the caller to spell the digits to find the person in the Dial By Name directory. This feature allows customers/clients to use the guided automatic system to contact the enterprise employees without having to know the extension number, which brings convenience and improves business image for the enterprise.

### Dial By Name Configuration

The administrators can create the dial by name group under Web GUI→**Call Features**→**Dial By Name**.



The screenshot shows the 'Create New Dial By Name' configuration interface. It includes the following fields and options:

- Name:** A text input field containing the word 'Name'.
- Extension:** A text input field containing '7101'.
- Custom Prompt:** A dropdown menu set to 'None' and an 'Upload Audio File' button.
- Members:** A list of 5 items (1000, 1001, 1002, 1003, 1004) in an 'Available' list, with an empty 'Selected' list.
- LDAP Phonebook:** Two empty lists, one 'Available' and one 'Selected'.
- Options:**
  - Prompt Wait Time:** A text input field containing '5'.
  - Query Type:** Radio buttons for 'By Last Name + First Name' (selected), 'By First Name + Last Name'.
  - Select Type:** Radio buttons for 'By Order' (selected), 'By Menu'.

Figure 226: Create Dial By Name Group

User Settings

First Name:	<input type="text" value="John"/>	Last Name:	<input type="text" value="DOE"/>
Email Address:	<input type="text"/>	* User Password:	<input type="password" value="*****"/>
* Language:	<input type="text" value="Default"/> ▼	* Concurrent Registration...	<input type="text" value="1"/>
Mobile Phone Number:	<input type="text"/>		

**Figure 227: Configure Extension First Name and Last Name**

**1. Name**

Enter a Name to identify the Dial By Name group.

**2. Extension**

Configure the direct dial extension for the Dial By Name group.

**3. Custom Prompt**

This option sets a custom prompt for directory to announce to a caller. The file can be uploaded from the page "Custom Prompt". Click "Upload Audio File" to add additional record.

**4. Available Extensions/Selected Extensions**

Select available extensions from the left side to the right side as the directory for the Dial By Name group. Only the selected extensions here can be reached by the Dial By Name IVR when dialing into this group. The extensions here must have a valid first name and last name configured under Web GUI → **Extension/Trunk** → **Extensions** in order to be searchable in Dial By Name directory through IVR. By specifying the extensions here, the administrators can make sure unscreened calls will not reach the company employee if he/she does not want to receive them directly.

**5. Prompt Wait Time**

Configure "Prompt Wait Time" for Dial By Name feature. During Dial By Name call, the caller will need to input the first letters of First/Last name before this wait time is reached. Otherwise, timeout will occur, and the call might hang up. The timeout range is between 3 and 60 seconds.

**6. Query Type**

Specify the query type. This defines how the caller will need to enter to search the directory.

By First Name: enter the first 3 digits of the first name to search the directory.

By Last Name: enter the first 3 digits of the last name to search the directory.

By Full Name: enter the first 3 digits of the first name or last name to search the directory.



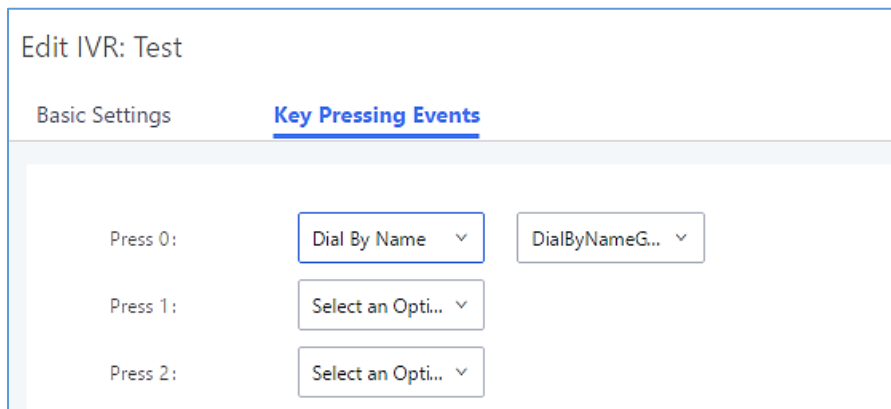
## 7. Select Type

Specify the select type on the searching result. The IVR will confirm the name/number for the party the caller would like to reach before dialing out.

**By Order:** After the caller enters the digits, the IVR will announce the first matching party's name and number. The caller can confirm and dial out if it is the destination party, or press \* to listen to the next matching result if it is not the desired party to call.

**By Menu:** After the caller enters the digits, the IVR will announce 8 matching results. The caller can press number 1 to 8 to select and call or press 9 for results in next page.

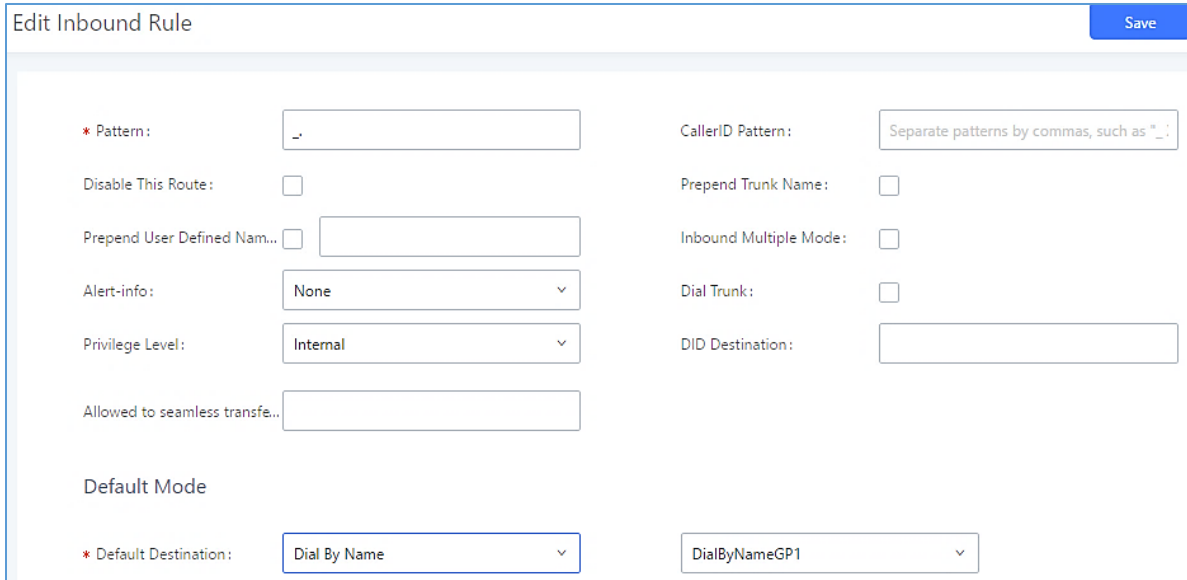
The Dial By Name group can be used as the destination for inbound route and key pressing event for IVR. The group name defined here will show up in the destination list when configuring IVR and inbound route. If Dial By Name is set as a key pressing event for IVR, users can dial star (\*) to exit from Dial By Name, and re-enter the IVR to start a new event. The following example shows how to use this option.



Edit IVR: Test  
 Basic Settings      **Key Pressing Events**

Press 0:	Dial By Name ▾	DialByNameG... ▾
Press 1:	Select an Opti... ▾	
Press 2:	Select an Opti... ▾	

**Figure 228: Dial By Name Group In IVR Key Pressing Events**



**Edit Inbound Rule** Save

\* Pattern:  CallerID Pattern:

Disable This Route:  Prepend Trunk Name:

Prepend User Defined Nam...   Inbound Multiple Mode:

Alert-info:  Dial Trunk:

Privilege Level:  DID Destination:

Allowed to seamless transfe...

Default Mode

\* Default Destination:

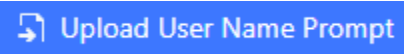


**Figure 229: Dial By Name Group In Inbound Rule**

## Username Prompt Customization



Starting from fw 1.0.15.x, the Dial By Name feature can use the recorded name prompt of a user to announce his/her name assigned to the dialed extension. If no name prompt greeting exists, the name will be spelt out like in previous versions.

There are two ways to customize/set new username prompt for an extension:

### Upload Username Prompt File from Web GUI

4. First, Users should have a pre-recorded file respecting the following format:
  - PCM encoded / 16 bits / 8000Hz mono.
  - In .GSM or .WAV format.
  - File size under 5M.
  - Filename must be set as the extension number. For example, the recorded file name 1000.wav will be used for extension 1000.
5. Go under web GUI **PBX Settings** → **Voice Prompt** → **Username Prompt** and click on  button.
6. Select the recorded file to upload it and press Save and Apply Settings.
  - Click on  to record again the username prompt.
  - Click on  to play recorded username prompt.



- Select username prompts and press  to delete specific file or select multiple files for deletion using the button  **Delete Selected User Name Prompt**.

## Record Username via Voicemail Menu

Users can also record their username via the voicemail menu:

- Dial \*97 or \*98 to access the voicemail menu. If \*98 is dialed, enter the desired extension and voicemail password.
- Upon entering the extension's voicemail system, dial 0 to enter the recordings menu.
- Press 3 to start recording the username.



## ACTIVE CALLS AND MONITOR

The active calls on the UCM6510 are displayed in Web GUI→**System Status**→**Active Calls** page. Users can monitor call status, hang up active call(s) as well as barge in active call(s) in real time manner.

### Active Calls Status

To view the status of active calls, navigate to Web GUI→**System Status**→**Active Calls**. The following figure shows extension 1000 is calling 1001. 1001 is ringing.

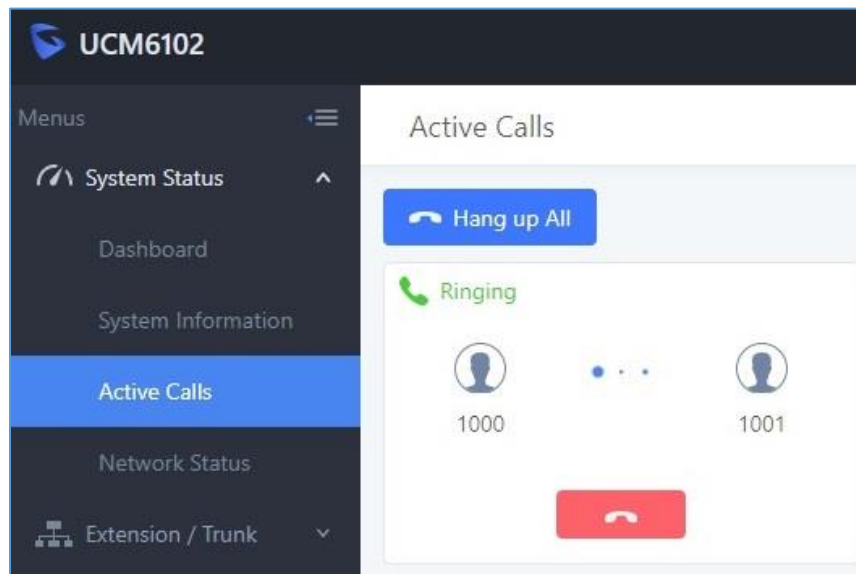


Figure 230: Status→PBX Status→Active Calls - Ringing

The following figure shows the call between 1002 and 1003 is established.

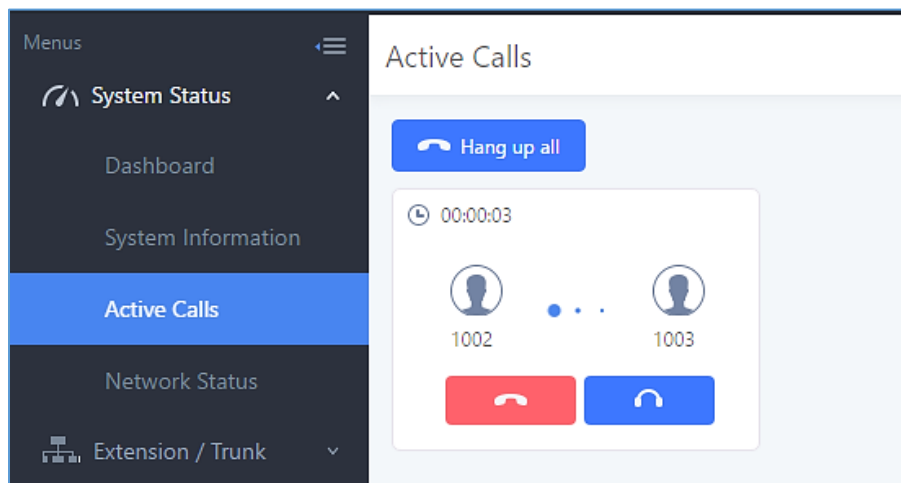
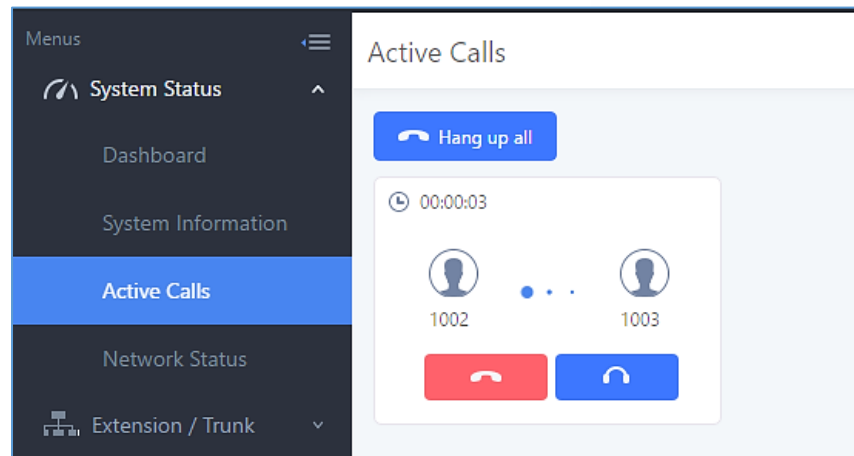


Figure 231: Status→PBX Status→Active Calls – Call Established

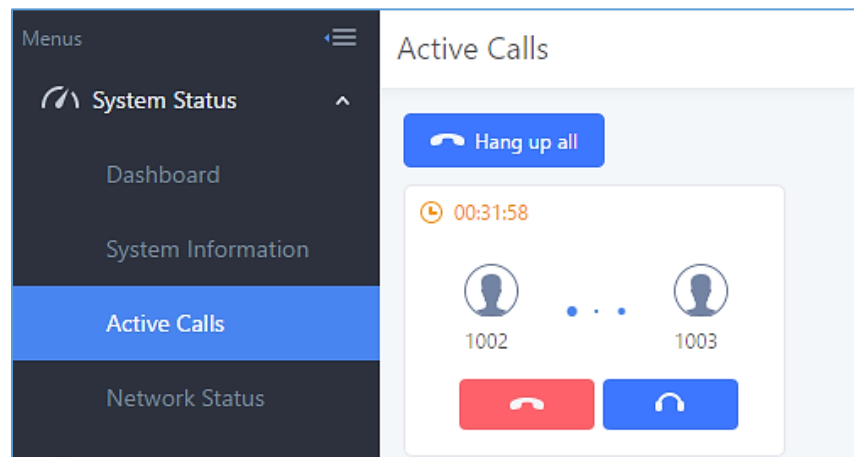


The black color of the active call means the connection of call time is less than half an hour. It means this call is normal.



**Figure 232: Call Connection less than half hour**

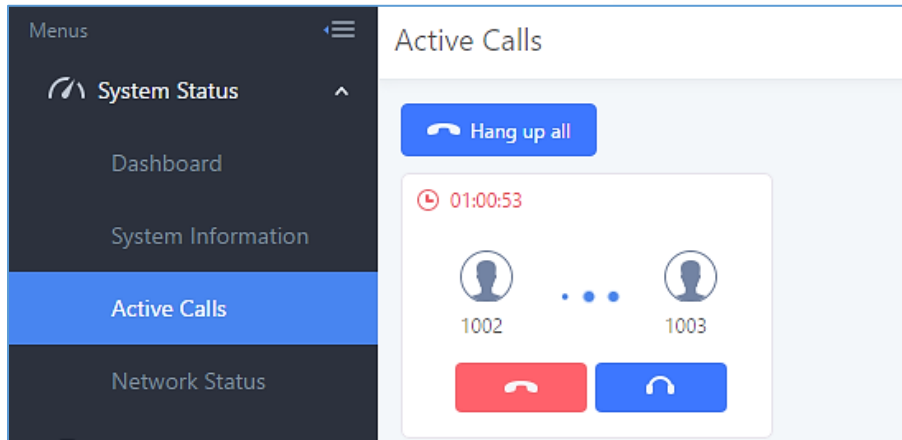
The yellow color of the active call means the connection of call time is greater than half an hour but less than one hour. It means this call is a bit long.



**Figure 233: Call Connection between half an hour and one hour**


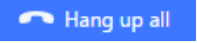
The red color of the active call means the connection of call time is more than one hour. It means this call could be abnormal.





**Figure 234: Call Connection more than one hour**

## Hang Up Active Calls

To hang up an active call, click on  icon in the active call dialog. Users can also click on  to hang up all active calls shown on the Active Calls page.

## Call Monitor

During an active call, click on icon  and the Monitor dialog will pop up.

**Figure 235: Configure to Monitor an Active Call**

In the “Monitor” dialog, configure the following to monitor an active call:



- Enter an available extension for “Monitor’s Extension” which will be used to monitor the active call.
- “Monitored Extension” must be one of the parties in the active call to be monitored.
- Select spy mode. There are three options in “Spy Mode”.
  - **Listen**

In “Listen” mode, the extension monitoring the call can hear both parties in the active call but the audio of the user on this extension will not be heard by either party in the monitored active call.
  - **Whisper**

In “Whisper” mode, the extension monitoring the call can hear both parties in the active call. The user on this extension can only talk to the selected monitored extension and he/she will not be heard by the other party in the active call. This can be usually used to supervise calls.
  - **Barge**

In “Barge” mode, the extension monitoring the call can talk to both parties in the active call. The call will be established similar to three-way conference.
- Enable or disable “Require Confirmation” option. If enabled, the confirmation of the invited monitor’s extension is required before the active call can be monitored. This option can be used to avoid adding participant who has auto-answer configured or call forwarded to voicemail.
- Click on “Add”. An INVITE will be sent to the monitor’s extension. The monitor can answer the call and start monitoring. If “Require Confirmation” is enabled, the user will be asked to confirm to monitor the call.

Another way to monitor active calls is to dial the corresponding feature codes from an extension. Please refer to [\[Table 105: UCM6510 Feature Codes\]](#) and [\[Call Recording\]](#) section for instructions.



## CALL FEATURES CODES

The UCM6510 supports call recording, transfer, call forward, call park and other call features via feature code. Feature Codes settings can be found at Web GUI→**Call Features**→**Feature Codes**. This section lists all the feature codes in the UCM6510 and describes how to use the call features.

### Feature Codes

Table 105: UCM6510 Feature Codes

Feature Maps	
<b>Blind Transfer</b>	<ul style="list-style-type: none"> <li>• Default code: <b>#1</b></li> <li>• Enter the code during active call. After hearing "Transfer", you will hear dial tone. Enter the number to transfer to. Then the user will be disconnected, and transfer is completed.</li> <li>• Options:  <b>Disable</b>  <b>Allow Caller:</b> Enable the feature code on caller side only.  <b>Allow Callee:</b> Enable the feature code on callee side only.  <b>Allow Both:</b> Enable the feature code on both caller and callee.</li> </ul>
<b>Attended Transfer</b>	<ul style="list-style-type: none"> <li>• Default code: <b>*2</b></li> <li>• Enter the code during active call. After hearing "Transfer", you will hear the dial tone. Enter the number to transfer to and the user will be connected to this number. Hang up the call to complete the attended transfer. In case of the called party does not answer, users could press *0 to cancel the call and retrieve the first call leg.</li> <li>• Options:  <b>Disable</b>  <b>Allow Caller:</b> Enable the feature code on caller side only.  <b>Allow Callee:</b> Enable the feature code on callee side only.  <b>Allow Both:</b> Enable the feature code on both caller and callee.</li> </ul>
<b>Seamless Transfer</b>	<ul style="list-style-type: none"> <li>• Default code: <b>*44</b> (Disabled by default).</li> <li>• Seamless Transfer allows user to perform blind transfer using UCM feature code without having music on hold presented during the transfer process, it minimizes the interruption during transfer, making the process smooth and simple.</li> <li>• During an active call use the feature code (*44 by default) followed by the number you want to transfer to in order to perform the seamless transfer.</li> </ul>



<b>Disconnect</b>	<ul style="list-style-type: none"> <li>• Default code: <b>*0</b></li> <li>• Enter the code during active call. It will disconnect the call.</li> <li>• Options:  <b>Disable</b>  <b>Allow Caller:</b> Enable the feature code on caller side only.  <b>Allow Callee:</b> Enable the feature code on callee side only.  <b>Allow Both:</b> Enable the feature code on both caller and callee.</li> </ul>
<b>Call Park</b>	<ul style="list-style-type: none"> <li>• Default code: <b>#72</b></li> <li>• Enter the code during active call to park the call.</li> <li>• Options:  <b>Disable</b>  <b>Allow Caller:</b> Enable the feature code on caller side only.  <b>Allow Callee:</b> Enable the feature code on callee side only.  <b>Allow Both:</b> Enable the feature code on both caller and callee.</li> </ul>
<b>Start/Stop Call Recording</b>	<ul style="list-style-type: none"> <li>• Default code: <b>*3</b></li> <li>• Enter the code followed by # or SEND to start recording the audio call and the UCM6510 will mix the streams natively on the fly as the call is in progress.</li> <li>• Options:  <b>Disable</b>  <b>Allow Caller:</b> Enable the feature code on caller side only.  <b>Allow Callee:</b> Enable the feature code on callee side only.  <b>Allow Both:</b> Enable the feature code on both caller and callee.</li> </ul>
<b>Feature Code Digits Timeout</b>	Set the maximum interval (ms) between digits for feature code activation
<b>DND/Call Forward</b>	
<b>Do Not Disturb (DND) Activate</b>	<ul style="list-style-type: none"> <li>• Default code: <b>*77</b></li> </ul>
<b>Do Not Disturb (DND) Deactivate</b>	<ul style="list-style-type: none"> <li>• Default code: <b>*78</b></li> </ul>
<b>Call Forward Busy Activate</b>	<ul style="list-style-type: none"> <li>• Default Code: <b>*90</b></li> <li>• Enter the code and follow the voice prompt. Or enter the code followed by the extension to forward the call.</li> </ul>
<b>Call Forward Busy Deactivate</b>	<ul style="list-style-type: none"> <li>• Default Code: <b>*91</b></li> </ul>
<b>Call Forward No Answer Activate</b>	<ul style="list-style-type: none"> <li>• Default Code: <b>*92</b></li> <li>• Enter the code and follow the voice prompt. Or enter the code followed by the extension to forward the call.</li> </ul>
<b>Call Forward No Answer Deactivate</b>	<ul style="list-style-type: none"> <li>• Default Code: <b>*93</b></li> </ul>



<b>Call Forward Unconditional Activate</b>	<ul style="list-style-type: none"> <li>• Default Code: <b>*72</b></li> <li>• Enter the code and follow the voice prompt. Or enter the code followed by the extension to forward the call.</li> </ul>
<b>Call Forward Unconditional Deactivate</b>	<ul style="list-style-type: none"> <li>• Default Code: <b>*73</b></li> </ul>
<b>Remote Call Forward Enable</b>	<ul style="list-style-type: none"> <li>• If enabled, this option will allow specific extensions to dial the remote call forwarding feature codes to set call forwarding for any extension.</li> </ul>
<b>Remote Call Forward Busy Enable</b>	<ul style="list-style-type: none"> <li>• Default Code: <b>*65</b></li> <li>• Enter the code and follow the voice prompt to set the remote extension number where you want to enable Call Forward Busy and the target destination.</li> </ul>
<b>Remote Call Forward Busy Disable</b>	<ul style="list-style-type: none"> <li>• Default Code: <b>*651</b></li> <li>• Enter the code and follow the voice prompt to set the remote extension number where you want to disable the Call Forward Busy.</li> </ul>
<b>Remote Call Forward No Answer Enable</b>	<ul style="list-style-type: none"> <li>• Default Code: <b>*66</b></li> <li>• Enter the code and follow the voice prompt to set the remote extension number where you want to enable Call Forward No Answer and the target destination.</li> </ul>
<b>Remote Call Forward No Answer Disable</b>	<ul style="list-style-type: none"> <li>• Default Code: <b>*661</b></li> <li>• Enter the code and follow the voice prompt to set the remote extension number where you want to disable the Call Forward No Answer.</li> </ul>
<b>Remote Call Forward Unconditional Enable</b>	<ul style="list-style-type: none"> <li>• Default Code: <b>*67</b></li> <li>• Enter the code and follow the voice prompt to set the remote extension number where you want to enable Call Forward Unconditional and the target destination.</li> </ul>
<b>Remote Call Forward Unconditional Disable</b>	<ul style="list-style-type: none"> <li>• Default Code: <b>*671</b></li> <li>• Enter the code and follow the voice prompt to set the remote extension number where you want to disable the Call Forward Unconditional.</li> </ul>
<b>Remote Call Forward Whitelist</b>	Only the Extensions selected in this whitelist can configure call forwarding for any extension via feature codes.
<b>Feature Codes</b>	
<b>Voicemail Access Code</b>	<ul style="list-style-type: none"> <li>• Default Code: <b>*98</b></li> <li>• Enter *98 and follow the voice prompt. Alternatively, dial *98 followed by the extension and pound (#) to immediately access the entered extension's voicemail box.</li> </ul>



<b>My Voicemail</b>	<ul style="list-style-type: none"> <li>• Default Code: <b>*97</b></li> <li>• Press *97 to access the voicemail box.</li> </ul>
<b>Agent Pause</b>	<ul style="list-style-type: none"> <li>• Default Code: <b>*83</b></li> <li>• Pause the agent in all call queues.</li> </ul>
<b>Agent Unpause</b>	<ul style="list-style-type: none"> <li>• Default Code: <b>*84</b></li> <li>• Unpause the agent in all call queues.</li> </ul>
<b>Paging Prefix</b>	<ul style="list-style-type: none"> <li>• Default Code: <b>*81</b></li> <li>• To page an extension, enter the code followed by the extension number.</li> </ul>
<b>Intercom Prefix</b>	<ul style="list-style-type: none"> <li>• Default Code: <b>*80</b></li> <li>• To intercom an extension, enter the code followed by the extension number.</li> </ul>
<b>Blacklist Add</b>	<ul style="list-style-type: none"> <li>• Default Code: <b>*40</b></li> <li>• To add a number to blacklist for inbound route, dial *40 and follow the voice prompt to enter the number.</li> </ul>
<b>Blacklist Remove</b>	<ul style="list-style-type: none"> <li>• Default Code: <b>*41</b></li> <li>• To remove a number from current blacklist for inbound route, dial *41 and follow the voice prompt to remove the number.</li> </ul>
<b>Call Pickup on Ringing</b>	<ul style="list-style-type: none"> <li>• Default Code: <b>**</b></li> <li>• To pick up a call for any extension xxxx, enter the code followed by the extension number xxxx.</li> </ul>
<b>Pickup In-call</b>	<ul style="list-style-type: none"> <li>• Default Code: <b>*45</b> (Disabled by default).</li> <li>• If “Pickup In-call” feature is enabled, only the extensions added in “Allowed to seamless transfer” in the extension’s Seamless Transfer Privilege Control List” can pick up the call.</li> </ul>
<b>Pickup Extension</b>	<ul style="list-style-type: none"> <li>• Default Code: <b>*8</b></li> <li>• This code is for the pickup group, which can be assigned for each extension on the extension configuration page.</li> <li>• If there is an incoming call to an extension, other extensions within same pickup group can dial *8 directly to pick up the call.</li> </ul>
<b>Direct Dial Voicemail Prefix</b>	<ul style="list-style-type: none"> <li>• Default Code: <b>*</b></li> <li>• This code is for the user to directly dial or transfer to an extension's voicemail.</li> <li>• For example, directly dial *5000 will have to call go into the extension 5000's voicemail. If the user would like to transfer the call to the extension 5000's voicemail, enter *5000 as the transfer target number.</li> </ul>



<b>Direct Dial Mobile Phone Prefix</b>	<ul style="list-style-type: none"> <li>• Default Code: <b>*88</b></li> <li>• If you have the permission to call mobile phone number, use this prefix plus the extension number can dial the mobile phone number of this extension directly.</li> </ul>
<b>Call Completion Request</b>	<ul style="list-style-type: none"> <li>• Default Code: <b>*11</b></li> <li>• This code is for the user who wants to use Call Completion.</li> </ul>
<b>Call Completion Cancel</b>	<ul style="list-style-type: none"> <li>• Default Code: <b>*12</b></li> <li>• This code is to cancel Call Completion request.</li> </ul>
<b>Enable Spy</b>	Check this box to enable spy feature codes. Disabled by default.
<b>Listen Spy</b>	<ul style="list-style-type: none"> <li>• Default Code: <b>*54</b> ("Enable Spy" needs to be checked)</li> <li>• This is the feature code to listen in on a call to monitor performance. Monitor's line will be muted, and neither party will hear from the monitor's extension.</li> </ul>
<b>Whisper Spy</b>	<ul style="list-style-type: none"> <li>• Default Code: <b>*55</b> ("Enable Spy" needs to be checked)</li> <li>• This is the feature code to speak to one side of the call (for example, whisper to employees to help them handle a call). Only one side will be able to hear from the monitor's extension.</li> </ul>
<b>Barge Spy</b>	<ul style="list-style-type: none"> <li>• Default Code: <b>*56</b> ("Enable Spy" needs to be checked)</li> <li>• This is the feature code to join in on the call to assist both parties.</li> </ul>
<b>Wakeup Service</b>	<ul style="list-style-type: none"> <li>• Default Code: <b>*36</b></li> <li>• Dial this code to access UCM wakeup service, you can add, update, activate or deactivate wakeup service.</li> </ul>
<b>PMS Wakeup Service</b>	<ul style="list-style-type: none"> <li>• Default Code: <b>*35</b></li> <li>• Dial this code to access UCM PMS wakeup service, you can add, update, activate or deactivate PMS wakeup service.</li> </ul>
<b>Update PMS Room Status</b>	<ul style="list-style-type: none"> <li>• Default Code: <b>*23</b></li> <li>• Use this code with maid code to update PMS room status. Choose the status to set after hearing the prompt, for example: for maid 001 dial *23001 and then 1 after hearing the prompt.</li> </ul>
<b>Presence Status</b>	<ul style="list-style-type: none"> <li>• Dial this code to set the presence status of the extension.</li> <li>• Possible options are:             <ul style="list-style-type: none"> <li>1:"unavailable"</li> <li>2:"available"</li> <li>3:"away"</li> <li>4:"chat"</li> <li>5:"dnd"</li> <li>6:"userdef"</li> </ul> </li> </ul>



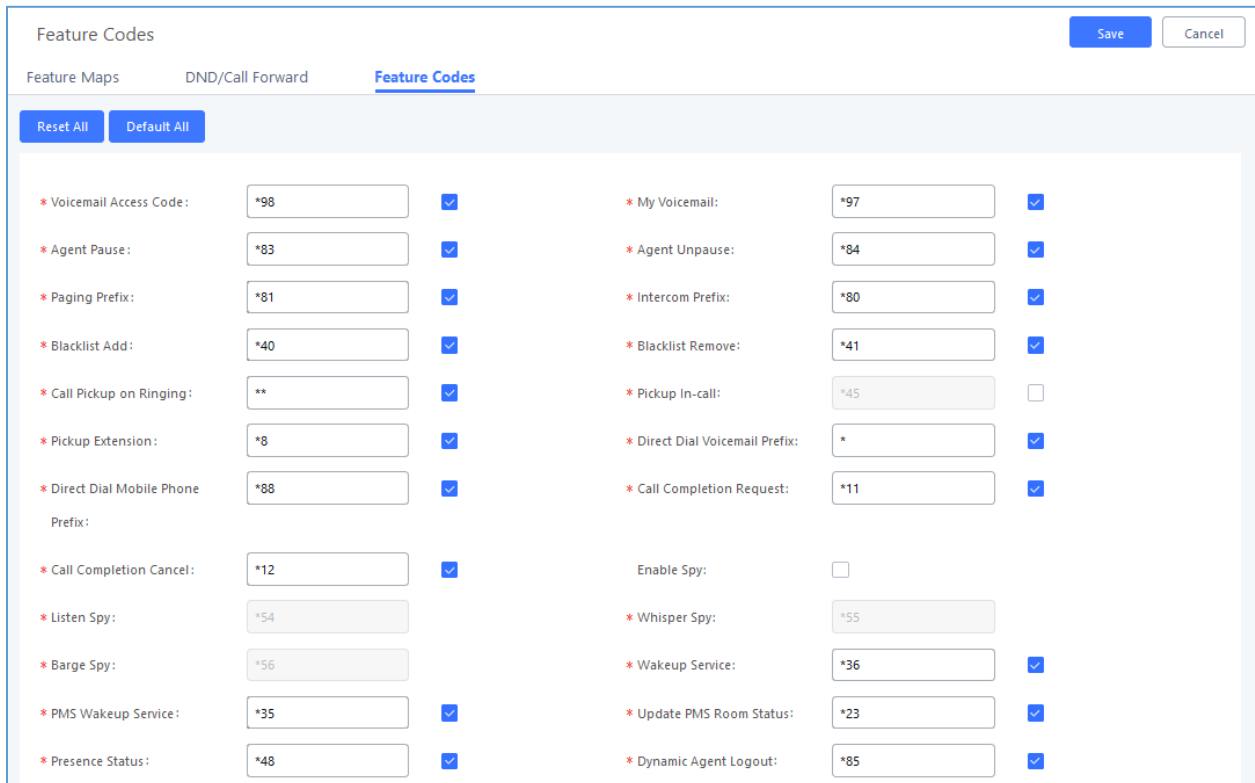
### Dynamic Agent Logout

- Default Code: \*85
- Use this code to logout the dynamic agent from all queues.

### Voicemail Group Access Code

Call voicemail group access code to access group voicemail. If password is required, enter password followed by pound "#" key.

The UCM6510 also allows user to enable / disable specific feature code by one click. As shown below:



Feature Code	Value	Enabled
* Voicemail Access Code:	*98	<input checked="" type="checkbox"/>
* Agent Pause:	*83	<input checked="" type="checkbox"/>
* Paging Prefix:	*81	<input checked="" type="checkbox"/>
* Blacklist Add:	*40	<input checked="" type="checkbox"/>
* Call Pickup on Ringing:	**	<input checked="" type="checkbox"/>
* Pickup Extension:	*8	<input checked="" type="checkbox"/>
* Direct Dial Mobile Phone Prefix:	*88	<input checked="" type="checkbox"/>
* Call Completion Cancel:	*12	<input checked="" type="checkbox"/>
* Listen Spy:	*54	<input type="checkbox"/>
* Barge Spy:	*56	<input type="checkbox"/>
* PMS Wakeup Service:	*35	<input checked="" type="checkbox"/>
* Presence Status:	*48	<input checked="" type="checkbox"/>
* My Voicemail:	*97	<input checked="" type="checkbox"/>
* Agent Unpause:	*84	<input checked="" type="checkbox"/>
* Intercom Prefix:	*80	<input checked="" type="checkbox"/>
* Blacklist Remove:	*41	<input checked="" type="checkbox"/>
* Pickup In-call:	*45	<input type="checkbox"/>
* Direct Dial Voicemail Prefix:	*	<input checked="" type="checkbox"/>
* Call Completion Request:	*11	<input checked="" type="checkbox"/>
Enable Spy:		<input type="checkbox"/>
* Whisper Spy:	*55	<input type="checkbox"/>
* Wakeup Service:	*36	<input checked="" type="checkbox"/>
* Update PMS Room Status:	*23	<input checked="" type="checkbox"/>
* Dynamic Agent Logout:	*85	<input checked="" type="checkbox"/>

Figure 236: Enable/Disable Feature codes

## Parking Lot

User can create parking lots and their related slots under Web GUI → **Call Features** → **Parking Lot**. In the Parking Lot page, users can create lots of their own. This allows different groups within an organization to have their own parking lots instead of sharing one large parking lot with others. While creating a new parking lot, users can assign it a range that they think is appropriate for the group that will use the parking lot.





Parking Lot			
Parking Lot Settings		Parking Lot Status	
+ Create New Parking Lot			
Extension	Name	Slots	Options
700	Sales	701-720	
730	Marketing	731-739	
740	Support	741-769	
Total: 3 < 1 >			10 / page v Goto 1

**Figure 237: Parking Lot**

User can create a new Parking lot by clicking on button “Create New Parking Lot” 

:

### Create New Parking Lot

<p>* Parking Lot Extension: <input type="text"/></p> <p>* Parking Slots: <input type="text"/></p> <p>* Parking Timeout (s): <input type="text" value="300"/></p> <p>Failover Destination: <input type="text"/></p> <p>Forward to Destination on Timeout: <input type="checkbox"/></p>	<p>* Parking Lot Name: <input type="text"/></p> <p>Use parklot as extension: <input type="checkbox"/></p> <p>Music On Hold Classes: <input type="text" value="Default"/></p> <p>Ring-All Callback on Timeout: <input type="checkbox"/></p>
---	--

**Figure 238: New Parking Lot**

**Table 106: Parking Lot**

<b>Parking Lot Extension</b>	<ul style="list-style-type: none"> <li>• Default Extension: <b>700</b></li> <li>• During an active call, initiate blind transfer and then enter this code to park the call.</li> </ul>
<b>Parking Lot Name</b>	<ul style="list-style-type: none"> <li>• Set a name to the parking lot</li> </ul>
<b>Parked Slots</b>	<ul style="list-style-type: none"> <li>• Default Extension: <b>701-720</b></li> <li>• These are the extensions where the calls will be parked, i.e., parking lots that the parked calls can be retrieved.</li> </ul>
<b>Use Parklot as Extension</b>	<ul style="list-style-type: none"> <li>• If checked, the parking lot number can be used as extension. The user can transfer the call to the parking lot number to park the call. Please note this parking lot number range might conflict with extension range.</li> </ul>



<b>Parking Timeout (s)</b>	<ul style="list-style-type: none"> <li>• Default setting is <b>300</b> seconds and the maximum limit is <b>99.999</b> seconds.</li> <li>• This is the timeout allowed for a call to be parked. After the timeout, if the call is not picked up, the extension who parks the call will be called back.</li> </ul>
<b>Music On Hold Playlist</b>	Select the Music on Hold Playlist.
<b>Failover Destination</b>	<p>Configures a callback failover destination when the extension that is called back is busy. The call will be routed to the destination number and this reduces the chance of dropping parked calls.</p> <p><b>Note:</b> This field cannot exceed 32 characters.</p>
<b>Ring All Callback on Timeout</b>	<p>If enabled, all registered endpoints of the extension will ring when callback occurs. Otherwise, the original endpoint will be called back.</p> <p><b>Note:</b> This option will not be available if Forward to Destination on Timeout is enabled.</p>
<b>Forward to destination on timeout</b>	If enabled, the call will be routed to the configured destination upon timeout. Otherwise, the call will be routed back to the original caller.
<b>Timeout Destination</b>	This option appears once Forward to Destination on Timeout is enabled. Upon park timeout, the call will be routed to the configured destination.

## Call Park

The UCM6510 provides call park and call pickup features via feature code.

### Park a Call

There are two feature codes that can be used to park the call.

- **Feature Maps→Call Park (Default code #72)**  
 During an active call, press #72 and the call will be parked. Parking lot number (default range 701 to 720) will be announced after parking the call.
- **Feature Misc→Call Park (Default code 700)**  
 During an active call, initiate blind transfer (default code #1) and then dial 700 to park the call. Parking lot number (default range 701 to 720) will be announced after parking the call.

### Retrieve Parked Call

To retrieve the parked call, simply dial the parking lot number and the call will be established. If a parked call is not retrieved before timeout, the original extension who parks the call will be called back.



## Monitor Call Park CID Name Information (GXP21xx Phones Only)

Users can see the CID name information of parked calls. VPK/MPKs must be configured as “Monitored Call Park” with the desired parking lot extension. The display will alternate between displaying the parking lot extension and the call’s CID name. There is no need to configure anything on the UCM.



**Note:** This feature requires Grandstream GXP21xx new firmware support. The new firmware should be available by now. Will need to verify with GXP team which firmware this was first supported.



Figure 239 : Monitored call park CID name

## Call Recording

The UCM6510 allows users to record audio during the call. If "Auto Record" is turned on for extension or trunk, the call will be automatically recorded when there is established call with the extension or trunk. Otherwise, please follow the instructions below to manually record the call.

1. Make sure the feature code for "Start/Stop Call Recording" is configured and enabled.
2. After establishing the call, enter the "Start/Stop Call Recording" feature code (by default \*3) followed by # or SEND to start recording.
3. To stop the recording, enter the "Start/Stop Call Recording" feature code (by default \*3) followed by # or SEND again. Or the recording will be stopped once the call hangs up.
4. The recording file can be retrieved under Web GUI→**CDR**. Click on  to show and play the recording or click on  to download the recording file.

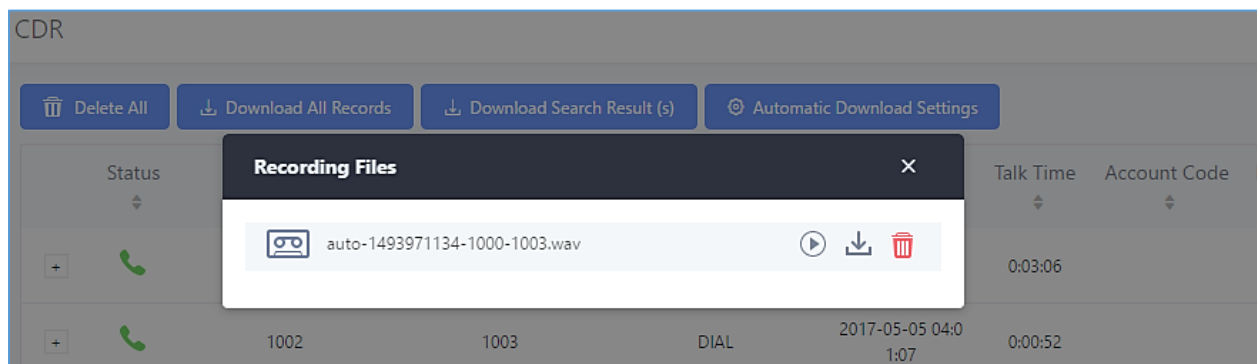


Figure 240: Download Recording File from CDR Page

The above recorded call's recording files are also listed under the UCM6510 Web GUI→**CDR**→**Recording Files**.

**Note:** Starting firmware 1.0.20.17, Music on Hold will be also included in the recording.



## Enable Spy

If “Enable Spy” option is enabled, feature codes for Listen Spy, Whisper Spy and Barge Spy are available for users to dial from any extension to perform the corresponding actions.

Assume a call is on-going between extension A and extension B, user could dial the feature code from extension C to listen on their call (\*54 by default), whisper to one side (\*55 by default), or barge into the call (\*56 by default). Then the user will be asked to enter the number to call, which should be either side of the active call, extension A or B in this example.

---

 **Warning:**

“Enable Spy” allows any user to listen to any call by dialing feature codes. This may result in the leakage of user privacy. Please be aware of the associated potential security risk when enabling this feature.

---

## Shared Call Appearance (SCA)

Shared Call Appearance (SCA) functionality has been added to the UCM. With SCA, users can assign multiple devices to one extension, configure endpoints to monitor that extension, make actions on behalf of that extension such as viewing call status and placing and receiving calls, and even barging into existing calls. To configure the SCA functionality, please follow the steps below:

1. Users can enable SCA by navigating to the Extensions page, editing the desired extension, and enabling the option SCA.

**Note:** With SCA enabled, the Concurrent Registrations field can only have a value of 1.



Edit Extension: 1000

**Basic Settings**   Media   Features   Specific Time   Follow Me

General

* Extension:	<input type="text" value="1000"/>	CallerID Number:	<input type="text" value="1000"/>
* Permission:	<input type="text" value="Internal"/>	* SIP/IAX Password:	<input type="text" value="****"/>
AuthID:	<input type="text"/>	Voicemail:	<input type="text" value="Enable Local Voicemail"/>
* Voicemail Password:	<input type="text" value="*****"/>	Skip Voicemail Password Verification:	<input type="checkbox"/>
Send Voicemail to Email:	<input type="text" value="Default"/>	Keep Voicemail after Emailing:	<input type="text" value="Default"/>
Enable Keep-alive:	<input type="checkbox"/>	* Keep-alive Frequency:	<input type="text" value="60"/>
Disable This Extension:	<input type="checkbox"/>	Enable SCA:	<input type="checkbox"/>

**Figure 241: Enabling SCA Option under Extension's settings**

- After enabling the option, navigate to *Call Features* → *SCA*. The newly enabled SCA extension will be listed. Click the “+” button under the Options column to add a number that will share the main extension's call appearance, which will be called private numbers.

SCA

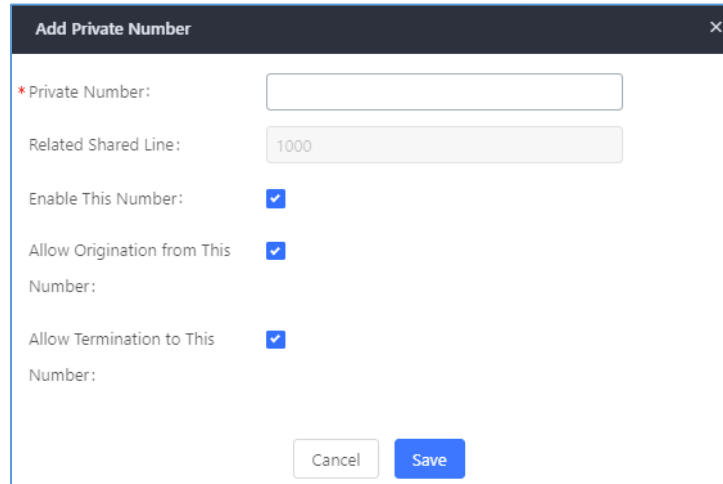
**SCA Number Group**   SCA Line Status

Status	Shared Line	Role	IP and Port	Subscribed	Options
<input type="checkbox"/> Unavailable	1000	shared	--	no	<input type="checkbox"/>

**Figure 242: SCA Number Configuration**

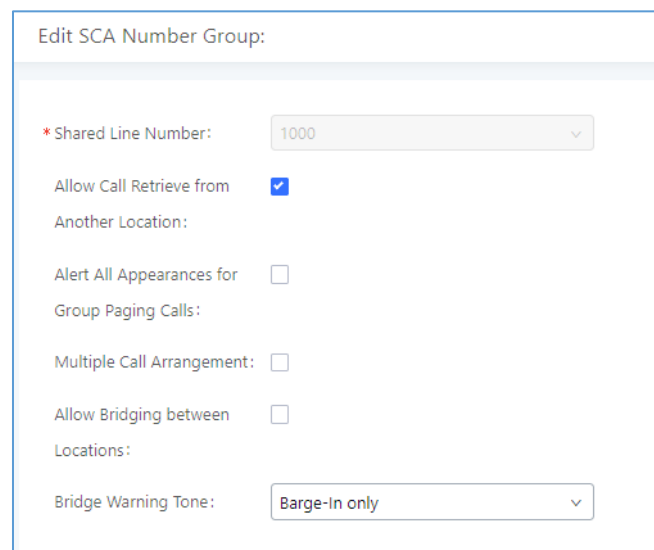
- Configure the private number as desired.





**Figure 243: SCA Private Number Configuration**

- Once the private number has been created, users must now register a device to it. To properly register a device to the private number, use the configured private number as the SIP User ID. Auth ID and Password will be the same as the main extension's. Once registration is complete, SCA is now configured.



**Figure 244: SCA Options**

SCA has various options to change its behavior :

- **Allow Call Retrieve from Another Location** – Allows users to retrieve held calls using any device associated with the SCA extension.
- **Alert All Appearances for Group Paging Calls** – Alerts all devices associated with the SCA extension.
- **Multiple Call Arrangement** – Allows all devices associated with the SCA extension to make different calls at the same time.



- **Allow Bridging between Locations** – Allows devices associated with the SCA extension to barge into existing calls of the same SCA group.
- **Bridge Warning Tone** – Notification sound that will play when a party barges into the call. Three options are available :
  - None – No notification sound will play
  - Barge-In Only – The notification sound will play once when a party barges in.
  - Barge-In and Repeat – The notification sound will play when a party barges in and will play again after every 30 seconds.

5. Next, configure the VPK or MPK to Shared for both the main extension and the private number. SCA is now configured for both endpoint devices.

The following table describes the SCA Number configuration setting:

**Table 107: Add SCA Private Number**

<b>Private Number</b>	Configures the private number for the SCA.
<b>Related Shared Line</b>	Display the related shared line.
<b>Enable This Number</b>	Enables/disables the private number.
<b>Allow Origination from This Number</b>	Enabling this option will allow calling from this private number. By default, it is enabled.
<b>Allow Termination to This Number</b>	Enabling this option will allows calls to this private number. By default, it is enabled.

The following table describes the options available when editing the SCA number:

**Table 108: Editing the SCA Number**

<b>Shared Line Number</b>	While SCA is enabled, this number will be the same as the extension number.
<b>Allow Call Retrieve from Another Location</b>	Allows remote call retrieval. Must be enabled in public hold. By default, it is enabled.
<b>Alert All Appearances for Group Paging Calls</b>	Allows all SCA group members to ring when the SCA shared number is paged. If disabled, only the SCA shared number will ring when paged. By default, it is disabled.
<b>Multiple Call Arrangement</b>	Allows simultaneous calls in an SCA group. By default, it is disabled.



<b>Allow Bridging between Locations</b>	Allows location bridging for SCA group. Must be enabled when using the Barge-In feature. By default, it is disabled.
<b>Bridge Warning Tone</b>	<p>Configures the notification in the bridge when another party join.</p> <ul style="list-style-type: none"> <li>• <b>None:</b> No notification sound.</li> <li>• <b>Barge-In only:</b> Notification sound will play when another party join.</li> <li>• <b>Barge-In and Repeat:</b> Notification sound will play when another party joins and repeat every 30 seconds.</li> </ul> <p>By default, it is set to “Barge-In Only”.</p>

## Announcement

The Announcement feature (not to be confused with Announcement Paging and Announcement Center) is a feature that allows users to set an unskippable audio file to play to callers before routing them to a configured destination. Announcements can be configured as a destination in the [Inbound Routes] or in [IVR].

To configure the Announcement, users need to follow below steps:

1. Navigate on the web GUI under “**Call Features → Announcement**”
2. Click on **+ Add** to add a new Announcement.
3. Configure the required fields Name, Prompt, Default Destination to be used for the announcement.
4. Save and apply the configuration.

### Create New Announcement

\* Name:

Prompt:

Default Destination:

Figure 245: Announcement settings

The table below gives more description of the configuration parameters when creating Announcement.







**Table 109: Announcement Parameters**

<b>Name</b>	Configure the name of the Announcement. <b>Note:</b> Please use letters, digits, _ or – only and no more than 64 characters.
<b>Prompt</b>	Audio file that will be played before ringing the configured default destination. <b>Note:</b> Sound file must be PCM encoded, 16 bits at 8000Hz mono in mp3/wav format or raw ulaw/alaw/gsm file with .mp3/.wav/.ulaw/.alaw/.gsm suffix. The file size must be less than 5MB. If uploading a compressed file, the file must have .tar/.tgz/.tar.gz suffix. the file name must contain only letters, numbers or special characters -_. The file size must be less than 30MB. Filename cannot exceed 100 characters.
<b>Default Destination</b>	Select the destination where to send the call after playing the announcement. The available default destinations are: <ul style="list-style-type: none"> <li>• Extension</li> <li>• Conference Rooms</li> <li>• Video Conference</li> <li>• Voicemail</li> <li>• Voicemail Group</li> <li>• IVR</li> <li>• Ring Group</li> <li>• Queues</li> <li>• Fax</li> <li>• DISA</li> <li>• Dial By Name</li> <li>• External Number</li> <li>• Hang-up</li> </ul>

Created Announcements will be listed as shown below:





Announcement				
<a href="#">+ Add</a>				
NAME ↕	PROMPT ↕	DEFAULT DESTINATION	DEFAULT DESTINATION	OPTIONS
Announcement1	Alarm01	Extension	1000	 

< 1 >

Total: 1  Goto

**Figure 246: Announcement**

- Press  to edit the announcement.
- Press  to delete the announcement.

## PBX SETTINGS

This section describes internal options that have not been mentioned in previous sections yet. The settings in this section can be applied globally to the UCM6510, including general configurations, jitter buffer, RTP settings, hardware config and STUN monitor. The options can be accessed via Web GUI→**PBX Settings**→**General Settings**.

### General Settings

Table 110: PBX Settings/General

General Preferences	
<b>Global Outbound CID</b>	Configure the global CallerID used for all outbound calls when no other CallerID is defined with higher priority. If no CallerID is defined for extension or trunk, the global outbound CID will be used as CallerID.
<b>Global Outbound CID Name</b>	Configure the global CallerID Name used for all outbound calls. If configured, all outbound calls will have the CallerID Name set to this name. If not, the extension's CallerID Name will be used.
<b>Ring Timeout</b>	Configure the number of seconds to ring an extension before the call goes to the user's voicemail box. The default setting is 60. <b>Note:</b> This is the global value used for each extension if "Ring Timeout" field is left empty on the extension configuration page.
<b>Call Duration Limit</b>	Configure the maximum duration of call-blocking.
<b>Record Prompt</b>	If enabled, users will hear voice prompt before recording is started or stopped. For example, before recording, the UCM6510 will play voice prompt "The call will be recorded". The default setting is "No".
<b>Enable 486 to Failover Trunk</b>	Reroutes failed outbound calls that receive a 486 response through the failover trunk to retry the call. If disabled, calls that receive a 486 response will be terminated.
<b>Device Name</b>	Enter a name to identify the UCM. The name will be displayed on UCM web interface.
<b>International Call Prefix</b>	Configure the International prefix. Default is 00. If empty, international call prefix can be empty or +.  This parameter helps the UCM to identify the international call prefix for the country (00, 011, 810...) to avoid any conflict when using blacklist for specific countries.  When outbound blacklist is enabled, UCM will apply the following rule



	<p>"International Call Prefix+Country Code+Destination number".</p> <p>When making outbound call, UCM will check "International Call Prefix" then "Country Code", if the combination exists in the blacklist, then the call will fail, otherwise, the call will be authorized.</p> <p><b>For example:</b> If blacklist is selecting countries with prefix code 001, dialing a number like 00123456789 will be blocked even if the number is not part of blacklisted countries if "International Call Prefix" is not set. While in same example, if "International Call Prefix" is set to "00", UCM will allow the dialed number.</p>
<b>Extension Preferences</b>	
<p><b>Enforce Strong Password</b></p>	<p>If enabled, strong password will be enforced for the password created on the UCM6510. The default setting is enabled.</p> <p>Strong Password Rules:</p> <ol style="list-style-type: none"> <li>1. Password for voicemail, voicemail group, outbound route, DISA, call queue and conference require non-repetitive and non-sequential digits, with a minimum length of 4 digits. Repetitive digits pattern (such as 0000, 1111, 1234, 2345, and etc), or common digits' pattern (such as 111222, 321321 and etc) are not allowed to be configured as password.</li> <li>2. Password for extension registration, Web GUI admin login, LDAP and LDAP sync requires alphanumeric characters containing at least two categories of the following, with a minimum length of 4 characters. <ul style="list-style-type: none"> <li>• Numeric digits</li> <li>• Lowercase alphabet characters</li> <li>• Uppercase alphabet characters</li> <li>• Special characters</li> </ul> </li> </ol>
<p><b>Enable Random Password</b></p>	<p>If enabled, random password will be generated when the extension is created. The default setting is "Yes". It is recommended to enable it for security purpose.</p>
<p><b>Enable Auto E-mail Notification</b></p>	<p>If enabled, UCM6510 will send Email notification to user automatically after editing extension settings or adding a new extension.</p>
<p><b>Disable Extension Range</b></p>	<p>If set to "Yes", users could disable the extension range pre-configured/configured on the UCM6510. The default setting is "No". The default extension range assignment is shown in "Extension Ranges" below.</p> <p><b>Note:</b> While there are no issues with disabling extension ranges, system administrators will need to manage extensions to avoid extension conflicts.</p>



## Extension Ranges

The default extension range assignment is:

- User Extensions: 1000-6299  
User Extensions is referring to the extensions created under Web GUI→**Extension/Trunk**→**Extensions** page.
- Pick Extensions: 4000-4999  
This refers to the extensions that can be manually picked from end device when being provisioned by the UCM6510. There are two related options in zero config page→Auto Provision Settings, "Pick Extension Segment" and "Enable Pick Extension". If "Enable Pick Extension" under zero config settings is selected, the extension list defined in "Pick Extension Segment" will be sent out to the device after receiving the device's request. This "Pick Extension Segment" should be a subset of the "Pick Extensions" range here. This feature is for the GXP series phones that support selecting extension to be provisioned via phone's LCD.
- Auto Provision Extensions: 5000-6299  
This sets the range for "Zero Config Extension Segment" which is the extensions can be assigned on the UCM6510 to provision the end device.
- Conference Extensions: 6300-6399
- Ring Group Extensions: 6400-6499
- Queue Extensions: 6500-6599
- Voicemail Group Extensions: 6600-6699
- IVR Extensions: 7000-7100
- Dial By Name Extensions: 7101-7199
- Fax Extensions: 7200-8200

## Call Failure Tone Settings

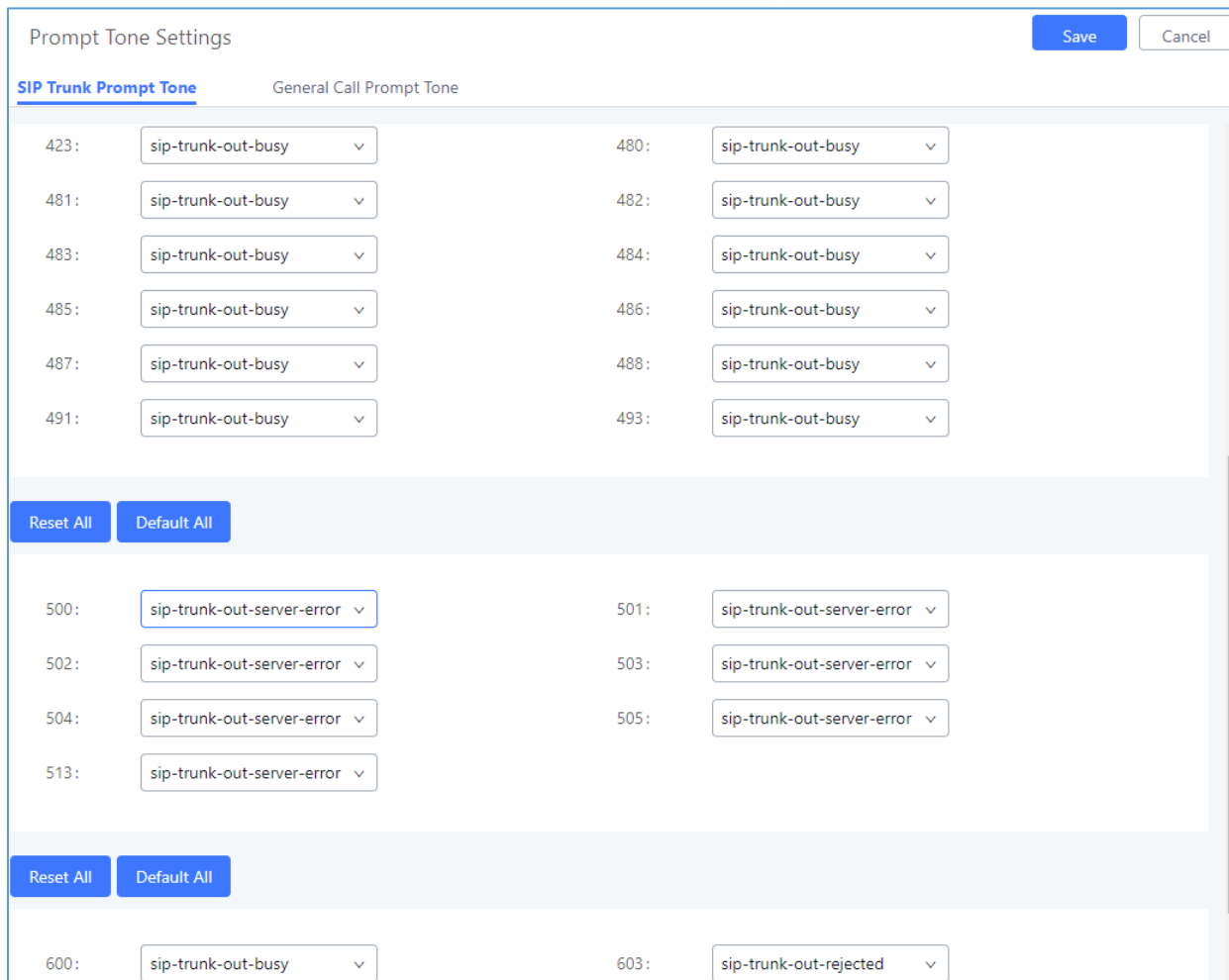
### SIP Trunk Prompt Tone

**Prompt Tone Settings** tab has been added to the UCM to help users choose which prompt will be played by the UCM during call failure, the following voice message responses have been added and can be set to be played for 4XX, 5XX, and 6XX call failures:

- Default for 404 and 604 status codes: *"Your call can't be completed as dialed. Please check the number and dial again."*
- Default for 5xx status codes: *"Server error. Please check your device."*
- Default for 403 and 603 status codes: *"The call was rejected by the server. Please try again later."*
- Default for all other status codes: *"All circuits are busy now. Please try again later."*



Additionally, custom voice messages recorded and uploaded in **PBX Settings**→**Voice Prompt**→**Custom Prompt** can be used for these failure responses instead of the default messages.



**Figure 247: SIP Trunk Prompt Tone**

## General Call Failure Tone

Moreover, users also have the possibility to customize the prompt for typical call failure reasons like (no permission to allow outbound calls, busy lines, incorrect number dialed ...Etc).

To customize these prompts user could record and upload their own files under “**PBX Settings** → **Voice Prompt** → **Custom Prompts**” then select each one for specific call failure case under “**PBX Settings** -> **Prompt Tone Settings** → **General Call Prompt Tone**” page as shown on the following figure:



Call Failure Tone Settings Save Cancel

SIP Trunk Prompt Tone General Call Failure Tones

Reset All Default All

Specify the tones to play for various general call failure scenarios.

Bad Number: <input type="text" value="wrong-number"/>	Out Of Service: <input type="text" value="out-of-service"/>
User Busy: <input type="text" value="user-busy"/>	Trunk Busy: <input type="text" value="trunk-busy"/>
No Answer: <input type="text" value="no-answer"/>	No Permission: <input type="text" value="no-permission"/>
Do Not Disturb: <input type="text" value="vm-isunavail"/>	General Failed: <input type="text" value="general-failed"/>

**Figure 248: General call Failure Prompts**

## PBX Settings/Jitter Buffer

**Table 111: Internal Options/Jitter Buffer**

SIP Jitter Buffer	
<b>Enable Jitter Buffer</b>	Select to enable jitter buffer on the sending side of the SIP channel. The default setting is "No".
<b>Jitter Buffer Size</b>	Configure the time (in ms) to buffer. This is the jitter buffer size used in "Fixed" jitter buffer or used as the initial time for "adaptive" jitter buffer. The default setting is 100.
<b>Max Jitter Buffer</b>	Configure the maximum time (in ms) to buffer for "Adaptive" jitter buffer implementation or used as the jitter buffer size for "Fixed" jitter buffer implementation. The default setting is 200.
<b>Implementation</b>	Configure the jitter buffer implementation on the sending side of a SIP channel. The default setting is "Fixed". <ul style="list-style-type: none"> <li><b>Fixed</b> The size is always equal to the value of "Max Jitter Buffer".</li> <li><b>Adaptive</b> The size is adjusted automatically and the maximum value equals to the value of "Max Jitter Buffer".</li> </ul>

## PBX Settings/RTP Settings

### RTP Settings

**Table 112: Internal Options/RTP Settings**

<b>RTP Start</b>	Configure the RTP port starting number. The default setting is 10000.
<b>RTP End</b>	Configure the RTP port ending address. The default setting is 20000.



<b>Strict RTP</b>	Configure to enable or disable strict RTP protection. If enabled, RTP packets that do not come from the source of the RTP stream will be dropped. The default setting is "Disable".
<b>RTP Checksums</b>	Configure to enable or disable RTP Checksums on RTP traffic. The default setting is "Disable".
<b>ICE Support</b>	Configure whether to support ICE, ICE is the integrated use of STUN and TURN structure to provide reliable VoIP or video calls and media transmission, via a SIP request/ response model or multiple candidate endpoints exchanging IP addresses and ports, such as private addresses and TURN server address. It is enabled by default.
<b>TURN Server</b>	Configure TURN server address. TURN is an enhanced version of the STUN protocol and is dedicated to the processing of symmetric NAT problems.
<b>TURN Server Name</b>	Configure turn server account name.
<b>TURN Server Password</b>	Configure turn server account password.
<b>STUN Server</b>	Configure STUN server address, STUN protocol is a Client / Server – is also a Request / Response protocol, where it is used to check the connectivity between the two terminals, such as maintaining NAT binding entries keep alive agreement. The default STUN Server is stun.ipvideotalk.com Valid format: [(hostname   IP-address) [:' port] The default port number is 3478 if not specified.

## Payload

The UCM6510 payload type for audio codecs and video codes can be configured here.

**Table 113: Internal Options/Payload**

<b>AAL2-G.726</b>	Configure payload type for ADPCM (G.726, 32kbps, AAL2 codeword packing). The default setting is 112.
<b>DTMF</b>	Configured payload type for DTMF. The default setting is 101.
<b>G.721 Compatible</b>	Configure to enable/disable G.721 compatible. The default setting is Yes.
<b>G.726</b>	Configure the payload type for G.726 if "G.721 Compatible" is disabled. The default setting is 111.
<b>iLBC</b>	Configure the payload type for iLBC. The default setting is 97.
<b>H.264</b>	Configure the payload type for H.264. The default setting is 99.





<b>H.265</b>	Configure the payload type for H.264. The default setting is 114.
<b>H.263P</b>	Configure the payload type for H.263+. The default setting is 100 103.
<b>VP8</b>	Configure the payload type for VP8. The default setting is 108.
<b>Main Video FEC</b>	Configure the payload type for Main Video FEC, The default is 120
<b>RTP FECC</b>	Configure the payload type for RTP FECC, The default is 125
<b>RTX</b>	Configure the payload type for RTX, The default is 124

## PBX Settings/NAS

UCM supports saving call recordings and backing up/restoring system backups to a NAS server. The following options are available:

**Table 114: NAS Settings**

<b>Enable</b>	Toggles the NAS recording functionality.
<b>Host</b>	Configure the Domain or IP address of the NAS server. <b>Note:</b> Currently, only IP addresses are supported in the Host/IP field.
<b>Share Name</b>	Specify the name of the shared folder.
<b>Username</b>	Specify the account username to access the NAS server.
<b>Password</b>	Configure the account password to access the NAS server.
<b>Status</b>	If configured correctly, the Status field will show "Mounted", and the newly added NAS server will be shown on the Mounted Netdisk List. Additionally, the NAS will appear as a selectable storage option in the PBX Settings->Recording Storage page and CDR->Recording Files page.



## IAX SETTINGS

The UCM6510 IAX global settings can be accessed via Web GUI→**PBX**→**IAX Settings**.

### IAX Settings/General

**Table 115: IAX Settings/General**

<b>Bind Port</b>	Configure the port number that the IAX2 will be allowed to listen to. The default setting is 4569.
<b>Bind Address</b>	Configure the address that the IAX2 will be forced to bind to. The default setting is 0.0.0.0, which means all addresses.
<b>IAX1 Compatibility</b>	Select to configure IAX1 compatibility. The default setting is "No".
<b>No Checksums</b>	If selected, UDP checksums will be disabled and no checksums will be calculated/checked on systems supporting this feature. The default setting is "No".
<b>Delay Reject</b>	If enabled, the IAX2 will delay the rejection of calls to avoid DOS. The default setting is "No".
<b>ADSI</b>	Select to enable ADSI phone compatibility. The default setting is "No".
<b>Music On Hold Interpret</b>	Specify which Music On Hold playlist this channel would like to listen to when being put on hold. This music playlist is only effective if this channel has no music playlist configured and the bridged channel putting the call on hold has no "Music On Hold Suggest" setting.
<b>Music On Hold Suggest</b>	Specify which Music On Hold playlist to suggest to the bridged channel when putting the call on hold.
<b>Bandwidth</b>	Configure the bandwidth for IAX settings. The default setting is "Low".

### IAX Settings/Registration

**Table 116: IAX Settings/Registration**

IAX Registration Options	
<b>Min Reg Expire</b>	Configure the minimum period (in seconds) of registration. The default setting is 60.
<b>Max Reg Expire</b>	Configure the maximum period (in seconds) of registration. The default setting is 3600.
<b>IAX Thread Count</b>	Configure the number of IAX helper threads. The default setting is 10.
<b>IAX Max Thread Count</b>	Configure the maximum number of IAX threads allowed. The default setting is 100.



<b>Auto Kill</b>	If set to "yes", the connection will be terminated if ACK for the NEW message is not received within 2000ms. Users could also specify number (in milliseconds) in addition to "yes" and "no". The default setting is "yes".
<b>Authentication Debugging</b>	If enabled, authentication traffic in debugging will not show. The default setting is "No".
<b>Codec Priority</b>	Configure codec negotiation priority. The default setting is "Reqonly". <ul style="list-style-type: none"> <li>• <b>Caller</b> Consider the callers preferred order ahead of the host's.</li> <li>• <b>Host</b> Consider the host's preferred order ahead of the caller's.</li> <li>• <b>Disabled</b> Disable the consideration of codec preference all together.</li> <li>• <b>Reqonly</b> This is almost the same as "Disabled", except when the requested format is not available. The call will only be accepted if the requested format is available.</li> </ul>
<b>Type of Service</b>	Configure ToS bit for preferred IP routing.
<b>IAX Trunk Options</b>	
<b>Trunk Frequency</b>	Configure the frequency of trunk frames (in milliseconds). The default setting is 20.
<b>Trunk Time Stamps</b>	If enabled, time stamps will be attached to trunk frames. The default setting is "No".

## IAX Settings/Security

**Table 117: IAX Settings/Static Defense**

<b>Call Token Optional</b>	Enter a single IP address or a range of IP addresses for which call token validation is not required. For example: 11.11.11.11 11.11.11.11/22.22.22.22.
<b>Max Call Numbers</b>	Configure the maximum number of calls allowed for a single IP address.
<b>Max Unvalidated Call Numbers</b>	Configure the maximum number of Unvalidated calls for all IP addresses.
<b>Call Number Limits</b>	Configure to limit the number of calls for a give IP address of IP range.
<b>IP or IP Range</b>	Enter the IP address or a range of IP addresses to be considered for call number limits. For example: 11.11.11.11 11.11.11.11/22.22.22.22.



## SIP SETTINGS

The UCM6510 SIP global settings can be accessed via Web GUI→**PBX Settings**→**SIP Settings**.

### SIP Settings/General

Table 118: SIP Settings/General

<b>Realm For Digest Authentication</b>	Configure the host name or domain name for the UCM6510. Realms MUST be globally unique according to RFC3261. The default setting is grandstream. <b>Note:</b> Both FQDN and IP address are supported on this field.
<b>Bind UDP Port</b>	Configure the UDP port used for SIP. The default setting is 5060.
<b>Bind IP Address</b>	Configure the IP address to bind to. The default setting is 0.0.0.0, which means binding to all addresses.
<b>Allow Transfer</b>	If set to "No", all transfers initiated by the endpoint in the UCM6510 will be disabled (unless enabled in peers or users). The default setting is "Yes".
<b>MWI From</b>	When sending MWI NOTIFY requests, this value will be used in the "From:" header as the "name" field. If no "From User" is configured, the "user" field of the URI in the "From:" header will be filled with this value.
<b>Enable Diversion Header</b>	If disabled, the UCM will not forward the diversion header. <b>Note:</b> Diversion header will be included for Forward and transfer when the option is enabled.
<b>Block Collect Calls</b>	If enabled, collect calls will be blocked. <b>Note:</b> Collect calls are indicated by the header "P-Asserted-Service-Info: service-code=Backward Collect Call, P-Asserted-Service-Info: service-code=Collect Call".

### SIP Settings/Misc

Table 119: SIP Settings/Misc

Outbound SIP Registrations	
<b>Register Timeout</b>	Configure the register retry timeout (in seconds). The default setting is 20.
<b>Register Attempts</b>	Configure the number of registration attempts before the UCM6510 gives up. The default setting is 0, which means the UCM6510 will keep trying until the server side accepts the registration request.



Video	
<b>Max Bit Rate (kb/s)</b>	Configure the maximum bit rate (in kb/s) for video calls. The default setting is 384.
<b>Support SIP Video</b>	Select to enable video support in SIP calls. The default setting is "Yes".
<b>Reject Non-Matching INVITE</b>	If enabled, when rejecting an incoming INVITE or REGISTER request, the UCM6510 will always reject with "401 Unauthorized" instead of notifying the requester whether there is a matching user or peer for the request. This reduces the ability of an attacker to scan for valid SIP usernames. The default setting is "No".
SDP Attribute Passthrough	
<b>Enable Attribute Passthrough</b>	If enabled, and UCM receives a call that contains unknown FEC/FECC/FBCP attributes, they will be passed through the UCM unmodified.
Early Media	
<b>Enable Use Final SDP</b>	If enabled, call negotiation will use final response SDP.
Blind Transfer	
<b>Allow callback when blind transfer fails</b>	If enabled, the UCM will call back to the transferrer when blind transfer fails (due to the destination being busy or not answering. Note: This feature applies only to internal calls.). <b>Note:</b> This feature takes effect only on internal calls.
<b>Blind transfer timeout</b>	Configure the amount of time in seconds that the transferred party will wait for the destination to answer before being redirected back to the transferrer. Default is 60 seconds.
DNS	
<b>DNS mode</b>	This option affects the DNS query only during Calls. When you choose A&AAAA, UCM will do both A and AAAA type DNS query; when you chose A, UCM will only do A type DNS query; and when you chose AAAA, UCM will only do AAAA type DNS query.
Hold	
<b>Forward HOLD Requests</b>	Configure the UCM to forward HOLD requests instead of processing holds internally. This serves to meet the standards set by some providers that require HOLD requests to be passed along from endpoint to endpoint. This option is disabled by default. <b>Note:</b> Enabling this option may cause hold retrieval issues and MOH to not be heard.



## SIP Settings/Session Timer

**Table 120: SIP Settings/Session Timer**

<b>Force Timer</b>	If checked, always request and run session timer.
<b>Timer</b>	If checked, run session timer only when requested by other UA.
<b>Session Expire</b>	Configure the maximum session refresh interval (in seconds). The default setting is 1800.
<b>Min SE</b>	Configure the minimum session refresh interval (in seconds). The default setting is 90.

## SIP Settings/TCP and TLS



**Note:**

The configuration in this section requires system reboot to take effect.

**Table 121: SIP Settings/TCP and TLS**

<b>TCP Enable</b>	Configure to allow incoming TCP connections with the UCM6510. The default setting is "No".
<b>TCP Bind Address</b>	Configure the IP address for TCP server to bind to. 0.0.0.0 means binding to all interfaces. The port number is optional. If not specified, 5060 will be used.
<b>TLS Enable</b>	Configure to allow incoming TLS connections with the UCM6510. The default setting is "No".
<b>TLS Bind Address</b>	Configure the IP address for TLS server to bind to. 0.0.0.0 means binding to all interfaces. The port number is optional. If not specified, 5061 will be used.  <b>Note:</b> The IP address must match the common name (hostname) in the certificate. Please do not bind a TLS socket to multiple IP addresses. For details on how to construct a certificate for SIP, please refer to the following document: <a href="http://tools.ietf.org/html/draft-ietf-sip-domain-certs">http://tools.ietf.org/html/draft-ietf-sip-domain-certs</a>
<b>TLS Do Not Verify</b>	If enabled, the TLS server's certificate will not be verified when acting as a client. The default setting is "Yes".
<b>TLS Self-Signed CA</b>	This is the CA certificate if the TLS server being connected to requires self-signed certificate, including server's public key. This file will be renamed as "TLS.ca" automatically.



	<p><b>Note:</b> The size of the uploaded ca file must be under 2MB.</p>
<b>TLS Cert</b>	<p>This is the Certificate file (*.pem format only) used for TLS connections. It contains private key for client and signed certificate for the server. This file will be renamed as "TLS.pem" automatically.</p> <p><b>Note:</b> The size of the uploaded certificate file must be under 2MB.</p>
<b>TLS CA Cert</b>	<p>This file must be named with the CA subject name hash value. It contains CA's (Certificate Authority) public key, which is used to verify the accessed servers.</p> <p><b>Note:</b> The size of the uploaded CA certificate file must be under 2MB.</p>
<b>TLS CA List</b>	<p>Display a list of files under the CA Cert directory.</p>

## SIP Settings/NAT

Table 122: SIP Settings/NAT

<b>External Host</b>	<p>Configure a static IP address and port (optional) used in outbound SIP messages if the UCM6510 is behind NAT. If a hostname is used, it will be looked up only once.</p>
<b>Use IP address in SDP</b>	<p>If enabled, the SDP connection will use the IP address resolved from the external host.</p>
<b>External TCP Port</b>	<p>Configure the externally mapped TCP port when the UCM6510 is behind a static NAT or PAT.</p>
<b>External TLS Port</b>	<p>Configures the externally mapped TLS port when UCM6510 is behind a static NAT or PAT.</p>
<b>Local Network Address</b>	<p>Specify a list of network addresses that are considered inside of the NAT network. Multiple entries are allowed. If not configured, the external IP address will not be set correctly.</p> <p>A sample configuration could be as follows: 192.168.0.0/16</p>

## SIP Settings/TOS

Table 123: SIP Settings/ToS

<b>ToS For SIP</b>	<p>Configure the Type of Service for SIP packets. The default setting is None.</p>
<b>ToS For RTP Audio</b>	<p>Configure the Type of Service for RTP audio packets. The default setting is None.</p>



<b>ToS For RTP Video</b>	Configure the Type of Service for RTP video packets. The default setting is None.
<b>Default Incoming/Outgoing Registration Time</b>	Configure the default duration (in seconds) of incoming/outgoing registration. The default setting is 120.
<b>Max Registration/Subscription Time</b>	Configure the maximum allowed duration (in seconds) of incoming registration and subscription requests. Default value is 3600.
<b>Min Registration/Subscription Time</b>	Configure the minimum allowed duration (in seconds) of incoming registration and subscription requests. Default value is 60.
<b>Enable Relaxed DTMF</b>	Select to enable relaxed DTMF handling. This may cause audio to be mistaken for DTMF. The default setting is "No".
<b>DTMF Mode</b>	Select DTMF mode to send DTMF. The default setting is RFC4733. If "Info" is selected, SIP INFO message will be used. If "Inband" is selected, 64-kbit codec PCMU and PCMA are required. When "Auto" is selected, "RFC4733" will be used if offered. Otherwise "Inband" will be used. The default setting is "RFC4733".
<b>RTP Timeout</b>	During an active call, if there is no RTP activity before the configured timeout, the call will be terminated. The default setting is no timeout. <b>Note:</b> This setting does not apply to calls on hold.
<b>RTP Hold Timeout</b>	When the call is on hold, if there is no RTP activity before the configured timeout, the call will be terminated. This value of RTP Hold Timeout should be larger than RTP Timeout. The default setting is no timeout.
<b>RTP Keep-alive</b>	This feature can be used to avoid abnormal call drop when the remote provider requires RTP traffic during proceeding. For example, when the call goes into voicemail and there is no RTP traffic sent out from UCM, configuring this option can avoid voicemail drop. When configured, RTP keep-alive packet will be sent to remote party at the configured interval. If set to 0, RTP keep-alive is disabled.
<b>100rel</b>	Configure the 100rel setting on UCM6510. The default setting is "Yes".
<b>Trust Remote Party ID</b>	Configure whether the Remote-Party-ID should be trusted. The default setting is "No".
<b>Send Remote Party ID</b>	Configure whether the Remote-Party-ID should be sent or not. The default setting is "No".
<b>Generate In-Band Ringing</b>	Configure whether the UCM6510 should generate inband ringing or not. The default setting is "Never". <ul style="list-style-type: none"> <li>• <b>Yes:</b> The UCM6510 will send 180 Ringing followed by 183 Session</li> </ul>





	<p>Progress and in-band audio.</p> <ul style="list-style-type: none"> <li>• <b>No:</b> The UCM6510 will send 180 Ringing if 183 Session Progress has not been sent yet. If audio path is established already with 183 then send in-band ringing.</li> <li>• <b>Never:</b> Whenever ringing occurs, the UCM6510 will send 180 Ringing as long as 200OK has not been set yet. Inband ringing will not be generated even the end point device is not working properly.</li> </ul>
<b>Server User Agent</b>	<p>Configure the user agent string for the UCM6510.</p> <p><b>Note:</b> The value configured in the Server User Agent Value field will replace the whole User-Agent header value instead of just the "UCM6xxx" part.</p>
<b>Send Compact SIP Headers</b>	<p>If enabled, compact SIP headers will be sent. The default setting is "No".</p>

## Transparent Call-Info header

UCM supports transparent call info header in order to integrate GDS door system with GXP21XX Color phones, the UCM will forward the call-info header to the phone in order to request the live view from GDS door system and give the option to open the door via softkey.

```

Session Initiation Protocol (INVITE)
  Request-Line: INVITE sip:3001@192.168.6.36:5064 SIP/2.0
  Message Header
    Via: SIP/2.0/UDP 192.168.6.187:5060;rport;branch=z9hG4bKPj3217e67b-e74f-4f9f-b06f-afd3dcbbe29b
    From: "3002" <sip:3002@192.168.6.187>;tag=202dca4f-2b9d-4880-924c-d48cea7d0596
    To: <sip:3001@192.168.6.36>
    Contact: <sip:68aae6ea-f1d4-4e62-9987-446e718a2448@192.168.6.187:5060>
    Call-ID: 7f66bb20-0b9f-4828-a355-698853b8d9fb
    CSeq: 17559 INVITE
    Allow: OPTIONS, INFO, SUBSCRIBE, NOTIFY, PUBLISH, INVITE, ACK, BYE, CANCEL, UPDATE, PRACK, MESSAGE, REGISTER, REFER
    Supported: 100rel, timer, replaces, norefersub
    Session-Expires: 1800
    Min-SE: 90
    Call-Info: <https://192.168.6.186:443/capture/8001> ;purpose=GDS-view
    Max-Forwards: 70
    User-Agent: Grandstream UCM6202V1.5A 1.0.13.15
    Content-Type: application/sdp
    Content-Length: 547
  Message Body
  
```

Figure 249: Transparent Call-Info



## GDMS SETTINGS

UCM can synchronize its SIP accounts to GDMS cloud management system.

<http://www.grandstream.com/products/device-management/gdms>

To get started, log into your GDMS account and navigate to the System→API Developer page. Click on the Enable API Developer Mode button if it has not been enabled yet.

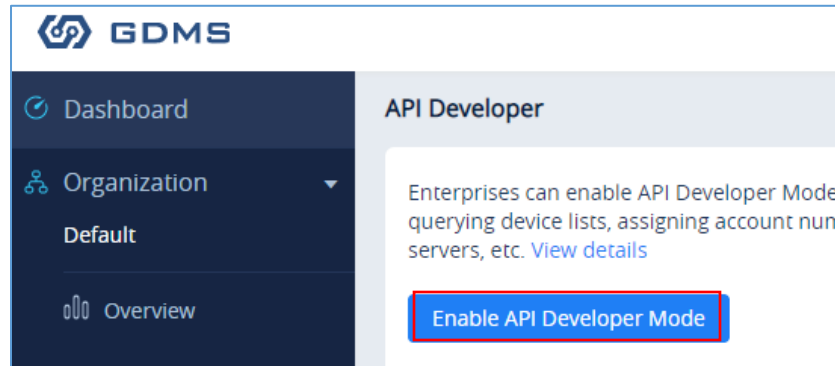


Figure 250: GDMS Developer Mode Button

After clicking on it, the API ID and Secret Key will be displayed. Note down these credentials.

On the UCM, navigate to System Settings→GDMS Settings. Check the Enable option if it has not been toggled on. Enter your GDMS account credentials and the API developer credentials.

For the *Account* field, enter either your account username or email address. Once all the information has been entered, click on the *Authenticate* button to connect to GDMS.

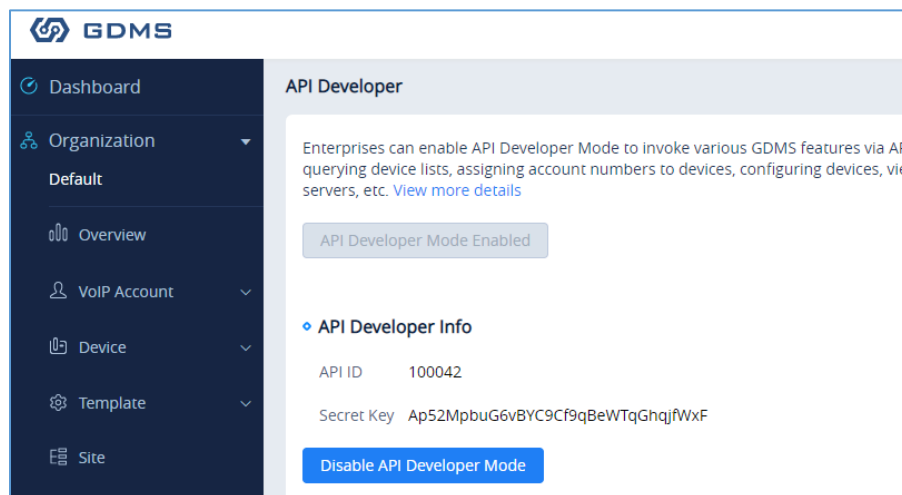


Figure 251: GDMS API Credentials



### GDMS Settings

UCM supports syncing all SIP extensions to GDMS Cloud Platform. After authentication, select the organization to sync extensions to. This funct

Enable:

\* Server Region:

\* Account Email/Username:

\* Password:

\* API ID:

\* Secret Key:

Connection Status: No authentication

Organization:

**Figure 252: GDMS Settings**

<b>Enable</b>	Toggles GDMS support. If enabled, all SIP extensions on the UCM will be automatically synced to GDMS.
<b>Server Region</b>	Select your GDMS server region: <ul style="list-style-type: none"> <li>• <b>US region</b></li> <li>• <b>EU region</b></li> </ul>
<b>Account Email/Username</b>	The account email/username for GDMS authentication.
<b>Password</b>	The password for GDMS authentication.
<b>API ID</b>	API ID from GDMS account. Refer to [Figure 251: GDMS API Credentials].
<b>Secret Key</b>	API secret key from GDMS account. Refer to [Figure 251: GDMS API Credentials].
<b>Connection Status</b>	Provides the connection status once authenticated.
<b>Organization</b>	Name of the organization in GDMS that the UCM SIP server and its extensions will be under.
<b>Authenticate</b>	Sends the authentication request to GDMS with the entered credentials.

If the authentication is successful, you will now be able to select an organization on GDMS to synchronize



all UCM SIP accounts to. After selecting, saving and applying changes, the UCM will then start the syncing process. Once the initial sync is complete, you will now be able see the UCM and its extensions on GDMS, which will have an orange label with the words “UCM”. Any future creation, deletion, or modification of SIP accounts will automatically be synchronized to GDMS.

SIP Server	
<input type="button" value="Delete"/>	
<input type="checkbox"/> Server Name	Server Address
<input type="checkbox"/> 192.168.42.63 <b>UCM</b>	192.168.42.63
Total 1	

**Figure 253: UCM on GDMS**

SIP Account				
<input type="button" value="Delete"/>				
<input type="checkbox"/> User ID	Account Name	Display Name	SIP Server	
<input type="checkbox"/> 1000 <b>UCM</b>	1000	1000	192.168.42.63	
<input type="checkbox"/> 1001 <b>UCM</b>	1001	1001	192.168.42.63	
<input type="checkbox"/> 1002 <b>UCM</b>	1002	1002	192.168.42.63	
<input type="checkbox"/> 1003 <b>UCM</b>	1003	1003	192.168.42.63	

**Figure 254: UCM SIP Extensions on GDMS**

Any future creation, modification, and deletion of the UCM’s SIP extensions will automatically be synchronized to GDMS.

**Note:** UCM extensions’ names currently cannot be synchronized.



## API CONFIGURATION

The UCM6510 supports third party billing interface API for external billing software to access CDR and call recordings on the PBX. The API uses HTTPS to request the CDR data and call recording data matching given parameters as configured on the third-party application. More methods are also supported to provide better integration with 3<sup>rd</sup> party systems.

Before accessing the API, the administrators need to enable the HTTPS API and configure the access/authentication information on the UCM6510 first under **Value-added Features**→**API Configuration**. The API configuration parameters are available for HTTPS API Settings (New), HTTPS API Settings (Old), CDR Real-time Output Settings & “Upload Prompts User Configuration”.

### HTTPS API (New)

Starting from firmware 1.0.20.17, UCM6510 supports new HTTPS API interface to query, edit PBX settings and implement multiple call functions on another server connected to it via API. PBX will actively send system reports and call reports to this other server. Additionally, legacy CDR API, REC API and PMS API are supported.

The table below lists configuration parameters for HTTPS API.

**Table 124: API Configuration Parameters**

HTTPS API Settings (New)	
<b>Enable</b>	Enable/Disable API. The default setting is disabled.
<b>Username</b>	Configure the username for API Authentication.
<b>Password</b>	Configure the password for API Authentication.
<b>Call Control</b>	If enabled, 3 <sup>rd</sup> party applications will be able to manage inbound calls via API actions. <b>acceptCall</b> will accept incoming calls while <b>refuseCall</b> will reject them. If no actions are done within 10 seconds, calls will automatically be accepted.

**Note:** HTTPS API uses web interface port (default is 8089).

The table below lists new HTTPS API supported methods.

**Table 125: New API Supported Queries**

getSystemStatus	addInboundRoute	listPaginggroup
getSystemGeneralStatus	getInboundRoute	addPaginggroup



listAccount	updateInboundRoute	getPaginggroup
getSIPAccount	deleteInboundRoute	updatePaginggroup
updateSIPAccount	playPromptByOrg	deletePaginggroup
listVoIPTrunk	listBridgedChannels	MulticastPaging
addSIPTrunk	listUnBridgedChannels	MulticastPagingHangup
getSIPTrunk	Hangup	listIVR
updateSIPTrunk	Callbarge	addIVR
deleteSIPTrunk	listQueue	getIVR
listOutboundRoute	getQueue	updateIVR
addOutboundRoute	updateQueue	deleteIVR
getOutboundRoute	addQueue	Cdrapi
updateOutboundRoute	deleteQueue	Recapi
deleteOutboundRoute	loginLogoffQueueAgent	Pmsapi
listInboundRoute	pauseUnpauseQueueAgent	Queueapi
listDigitalTrunk	listAnalogTrunk	getAnalogTrunk
deleteAnalogTrunk	updateAnalogTrunk	addAnalogTrunk
addSLATrunk	updateSLATrunk	addDigitalTrunk
updateDigitalTrunk	deletedigitalTrunk	getDigitalTrunk

For more details, please refer to online how-to guide available in our website.

## HTTPS API (Old)

Table 126: API Configuration Parameters (Old)

HTTPS API Settings (Old)	
Basic Settings	
<b>Enable</b>	Enable/Disable API. The default setting is disabled.
<b>TLS Bind Address</b>	Configure the IP address for TLS server to bind to. "0.0.0.0" means binding to all interfaces. The port number is optional, and the default port number is 8443. The IP address must match the common name (host name) in the certificate so that the TLS socket will not bind to multiple IP addresses. The default setting is 0.0.0.0:8443.



<b>Username</b>	Configure the username for TLS authentication.
<b>Password</b>	Configure the password for TLS authentication.
<b>Permitted IP(s)</b>	Specify a list of IP addresses permitted to use the API. This creates an API-specific access control list. Multiple entries are allowed.  For example, "192.168.40.3/255.255.255.255" denies access from all IP addresses except 192.168.40.3.  By default, this is blank, which indicates that no IP addresses are allowed to use this API.
<b>Other Settings</b>	
<b>TLS Private Key</b>	Upload TLS private key. The size of the key file must be under 2MB. This file will be renamed as 'private.pem' automatically.
<b>TLS Cert</b>	Upload TLS cert. The size of the certificate must be under 2MB. This is the certificate file (*.pem format only) for TLS connection. This file will be renamed as "certificate.pem" automatically. It contains private key for the client and signed certificate for the server.
<b>API Module</b>	
<b>CDR API</b>	Enable/disable CDR API module.
<b>REC API</b>	Enable/disable REC API module.
<b>PMS API</b>	Enable/disable PMS API module.

For more details on CDR API (Access to Call Detail Records), REC API (Access to Call Recording Files) and PMS API, please refer the document in the link here:

- [CDR API](#)
- [REC API](#)
- [PMS API](#)

## CDR Real-time Output Settings

CDR Real-time output feature allows to automatically send CDR records once available (after the call is terminated) to a specified server address.

Table 127: CDR Real-time Output Settings

CDR Real-time Output Settings	
<b>Enable</b>	Enables real-time CDR output module. This module connects to selected IP addresses and ports and posts CDR strings as soon as it is available.



<b>Server Address</b>	CDR server IP address
<b>Port</b>	CDR server IP port
<b>Delivery Method</b>	Choose either TCP protocol or HTTP/HTTPS protocol
<b>Format</b>	Choose either XML or JSON for CDR format
<b>Username</b>	Enter the Username for authentication.
<b>Password</b>	Enter the Password for authentication.

For more details, refer to online how-to guide available at:

[http://www.grandstream.com/sites/default/files/Resources/CDR\\_Real-time\\_Output\\_Feature\\_Guide.pdf](http://www.grandstream.com/sites/default/files/Resources/CDR_Real-time_Output_Feature_Guide.pdf)



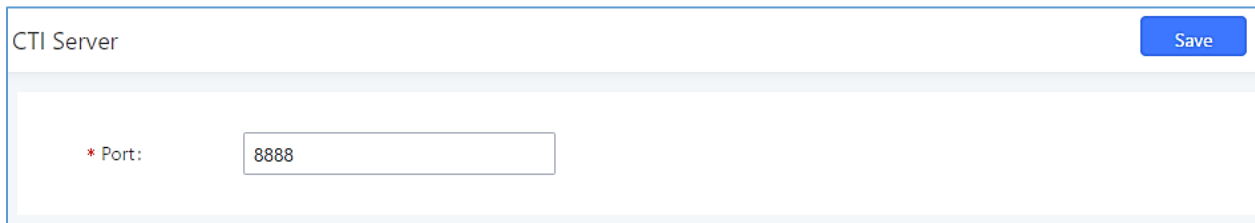


## CTI SERVER

UCM supports CTI server capabilities which are designed to be a part of the CTI solution suite provided by Grandstream, which involves the GXP17XX series, GXP21XX series and the GS Affinity application.

By default, the UCM listens to port 8888 for connection requests from the GS Affinity application. This will allow the UCM to interact with, modify, and execute requests by the application such as setting call forwarding and DND.

Users can change the listening port under the menu page, Web GUI→**Value-added Features**→**CTI Server** as shown on below screenshot:



The screenshot shows a web interface for configuring the CTI Server. The title is "CTI Server" and there is a "Save" button in the top right corner. Below the title, there is a field labeled "\* Port:" with a text input box containing the value "8888".

Figure 255: CTI Server Listening port

More information about GS affinity and CTI Support on Grandstream products series please refer to the following link: [http://www.grandstream.com/sites/default/files/Resources/GS\\_Affinity\\_Guide.pdf](http://www.grandstream.com/sites/default/files/Resources/GS_Affinity_Guide.pdf)

## ASTERISK MANAGER INTERFACE (RESTRICTED ACCESS)

Starting from firmware 1.0.1.10, the UCM6510 supports Asterisk Manager Interface (AMI) with restricted access. AMI allows a client program to connect to an Asterisk instance commands or read events over a TCP/IP stream. It is particularly useful when the system admin tries to track the state of a telephony client inside Asterisk.

User could configure AMI parameters on UCM6510 Web GUI→**Value-added Features**→**AMI**. For details on how to use AMI on UCM6510, please refer to the following AMI guide:

[http://www.grandstream.com/sites/default/files/Resources/UCM\\_series\\_AMI\\_guide.pdf](http://www.grandstream.com/sites/default/files/Resources/UCM_series_AMI_guide.pdf)

---

 **Warning:**

Please do not enable AMI on the UCM6510 if it is placed on a public or untrusted network unless you have taken steps to protect the device from unauthorized access. It is crucial to understand that AMI access can allow AMI user to originate calls and the data exchanged via AMI is often very sensitive and private for your UCM6510 system. Please be cautious when enabling AMI access on the UCM6510 and restrict the permission granted to the AMI user. By using AMI on UCM6510 you agree you understand and acknowledge the risks associated with this.

---



## CRM INTEGRATION

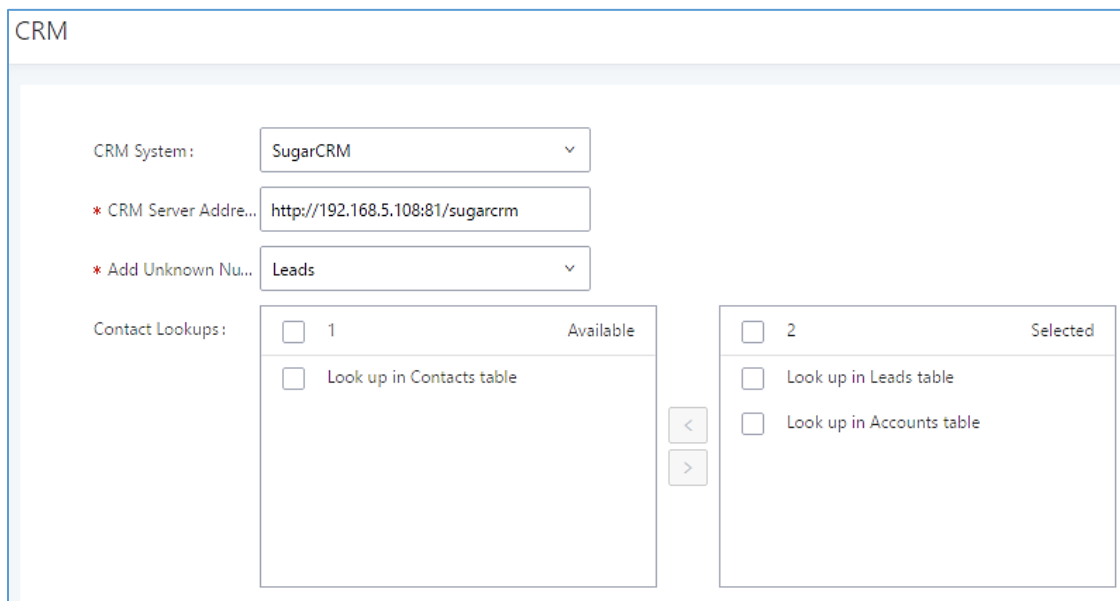
**Customer relationship management (CRM)** is a term that refers to practices, strategies and technologies that companies use to manage and analyze customer interactions and data throughout the customer lifecycle, with the goal of improving business relationships with customers.

The UCM6510 supports the following CRM API: SugarCRM, vTigerCRM, ZohoCRM (legacy v1 API), ZohoCRM (v2 API), Salesforce CRM and ACT! CRM. This support allows users to quickly create and modify contacts, leads, and accounts in the CRM from calls made through the UCM.

**Note:** Starting firmware 1.0.17.16, emergency calls will not be logged into CRM servers.

### SugarCRM

Configuration page of the SugarCRM can be accessed via admin login, on the UCM Web GUI → **Value-added Features** → **CRM**.



**Figure 256: SugarCRM Basic Settings**



1. Select “SugarCRM” from the CRM System Dropdown in order to use SugarCRM.

**Table 128: SugarCRM Settings**

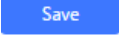
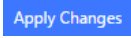
<b>CRM System</b>	Select a CRM system from the dropdown menu, four CRM systems are available: SugarCRM, vTigerCRM, ZohoCRM (legacy v1 API), ZohoCRM (v2 API), Salesforce or ACT! CRM.
<b>CRM Server Address</b>	Enter the IP address/URL of the CRM server.
<b>Add Unknown Number</b>	Add the new number to this module if it cannot be found in the selected module.


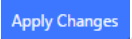


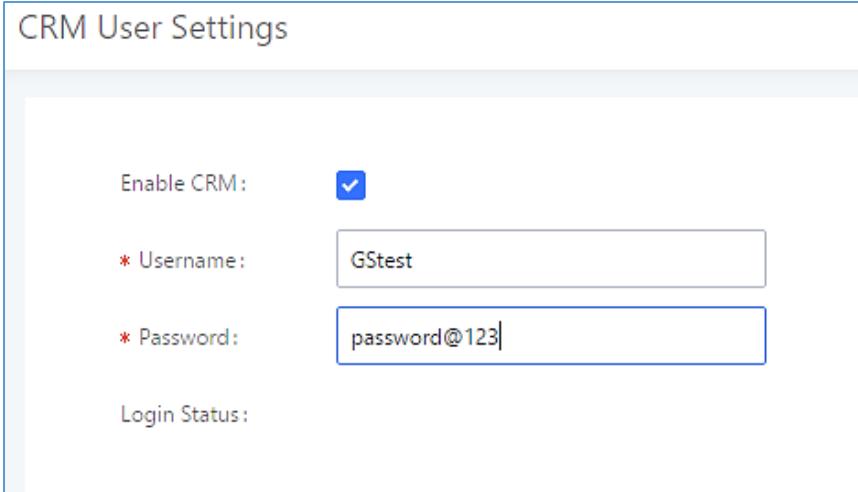
### Contact Lookups

Select from the “**Available**” list of lookups and press   to select where the UCM can perform the lookups on the CRM tables, Leads, Accounts, and Contacts.

Once settings on admin access are configured:

2. Click on  and .
3. Logout from admin access.
4. Login to the UCM as user and navigate under “**User Portal**→**Value-added Feature**→**CRM User Settings**”.

Click on “**Enable CRM**” and enter the username/password associated with the CRM account then click on  and . The status will change from “Logged Out” to “Logged In”. User can start then using SugarCRM features.



The screenshot shows the 'CRM User Settings' form. It includes the following fields and controls:

- Enable CRM:** A checkbox that is checked.
- \* Username:** A text input field containing 'GStest'.
- \* Password:** A text input field containing 'password@123'.
- Login Status:** A label with no input field.

Figure 257: CRM User Settings

## vTigerCRM

Configuration page of the vTigerCRM can be accessed via admin login, on the UCM Web GUI→**Value-added Features**→**CRM**.



**CRM**

---

CRM System:

\* CRM Server Address:

\* Add Unknown Number:

Contact Lookups:

<input type="checkbox"/> 0 item Available	<input type="button" value="←"/> <input type="button" value="→"/> <input type="button" value="↑"/> <input type="button" value="↓"/> <input type="button" value="↕"/>	<input type="checkbox"/> 3 items Selected
None		<input type="checkbox"/> Look up in Organizatio... <input type="checkbox"/> Look up in Leads table <input type="checkbox"/> Look up in Contacts ta...

**Figure 258: vTigerCRM Basic Settings**

1. Select “vTigerCRM” from the CRM System Dropdown in order to use vTigerCRM.

**Table 129: vTigerCRM Settings**

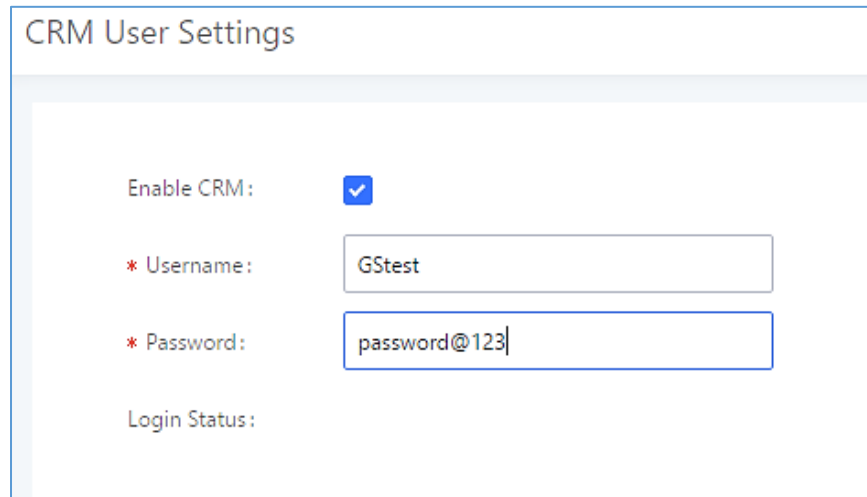
<b>CRM System</b>	Select a CRM system from the dropdown menu, four CRM systems are available: SugarCRM, vTigerCRM, ZohoCRM (legacy v1 API), ZohoCRM (v2 API), Salesforce or ACT! CRM.
<b>CRM Server Address</b>	Enter the IP address/URL of the CRM server.
<b>Add Unknown Number</b>	Add the new number to this module if it cannot be found in the selected module.
<b>Contact Lookups</b>	Select from the “ <b>Available</b> ” list of lookups and press   to select where the UCM can perform the lookups on the CRM tables, Leads, Organizations, and Contacts.

Once settings on admin access are configured:

2. Click on and .
3. Logout from admin access.
4. Login to the UCM as user and navigate under “User Portal→Value-added Feature→CRM User Settings”.



Click on **“Enable CRM”** and enter the username/password associated with the CRM account then click on **Save** and **Apply Changes**. The status will change from “Logged Out” to “Logged In”. User can start then using SugarCRM features.

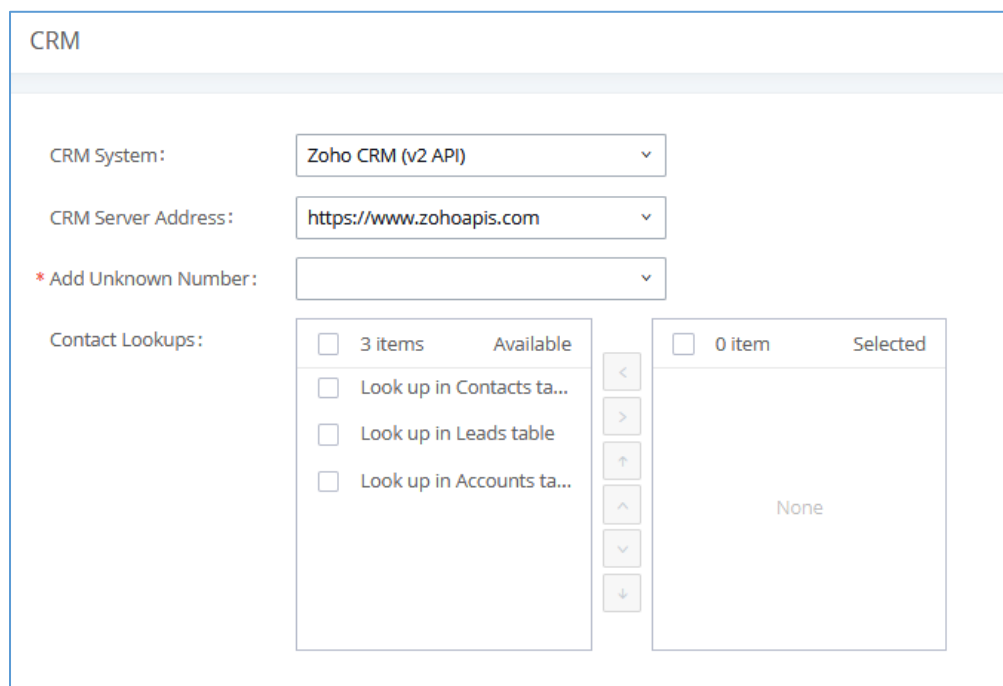


The screenshot shows the 'CRM User Settings' interface. It includes a checkbox for 'Enable CRM' which is checked. Below it are two required text input fields: '\* Username:' containing 'GStest' and '\* Password:' containing 'password@123'. At the bottom, there is a 'Login Status:' label.

**Figure 259: CRM User Settings**

## ZohoCRM

Configuration page of the ZohoCRM v1 and ZohoCRM v2 can be both accessed via admin login, on the UCM Web GUI → **Value-added Features** → **CRM**.



The screenshot shows the 'CRM' configuration page. It features several dropdown menus: 'CRM System:' set to 'Zoho CRM (v2 API)', 'CRM Server Address:' set to 'https://www.zohoapis.com', and '\* Add Unknown Number:' which is currently empty. Below these is a 'Contact Lookups:' section with a list of three items: 'Look up in Contacts ta...', 'Look up in Leads table', and 'Look up in Accounts ta...'. To the right of this list is a 'Selected' area showing '0 item' and 'None'. Navigation arrows are present between the list and the selected area.



**Figure 260: ZohoCRM Basic Settings**



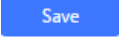
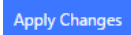
1. Select “ZohoCRM (v2 API)” from the CRM System Dropdown in order to use ZohoCRM.


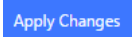
**Note:** Zoho CRM (legacy v1 API) will no longer be supported after 2019. Please use Zoho CRM (v2 API).

**Table 130: ZohoCRM Settings**

<b>CRM System</b>	Select CRM system from the dropdown menu, four CRM systems are available: SugarCRM, vTigerCRM, ZohoCRM (legacy v1 API), ZohoCRM (v2 API), Salesforce or ACT! CRM.
<b>CRM Server Address</b>	Select Zoho CRM URL from the list. Available options are: <ul style="list-style-type: none"> <li>• <a href="https://www.zohoapis.com">https://www.zohoapis.com</a></li> <li>• <a href="https://www.zohoapis.com.cn">https://www.zohoapis.com.cn</a></li> <li>• <a href="https://www.zohoapis.eu">https://www.zohoapis.eu</a></li> </ul>
<b>Add Unknown Number</b>	Add the new number to this module if it cannot be found in the selected module.
<b>Contact Lookups</b>	Select from the “ <b>Available</b> ” list of lookups and press   to select where the UCM can perform the lookups on the CRM tables, Leads, Accounts, and Contacts.

Once settings on admin access are configured:

2. Click on  and .
3. Logout from admin access.
4. Login to the UCM as user and navigate under “User Portal→Value-added Feature→CRM User Settings”.

Click on “**Enable CRM**” and enter the username/password associated with the CRM account then click on  and . The status will change from “Logged Out” to “Logged In”. User can start then using ZohoCRM features.



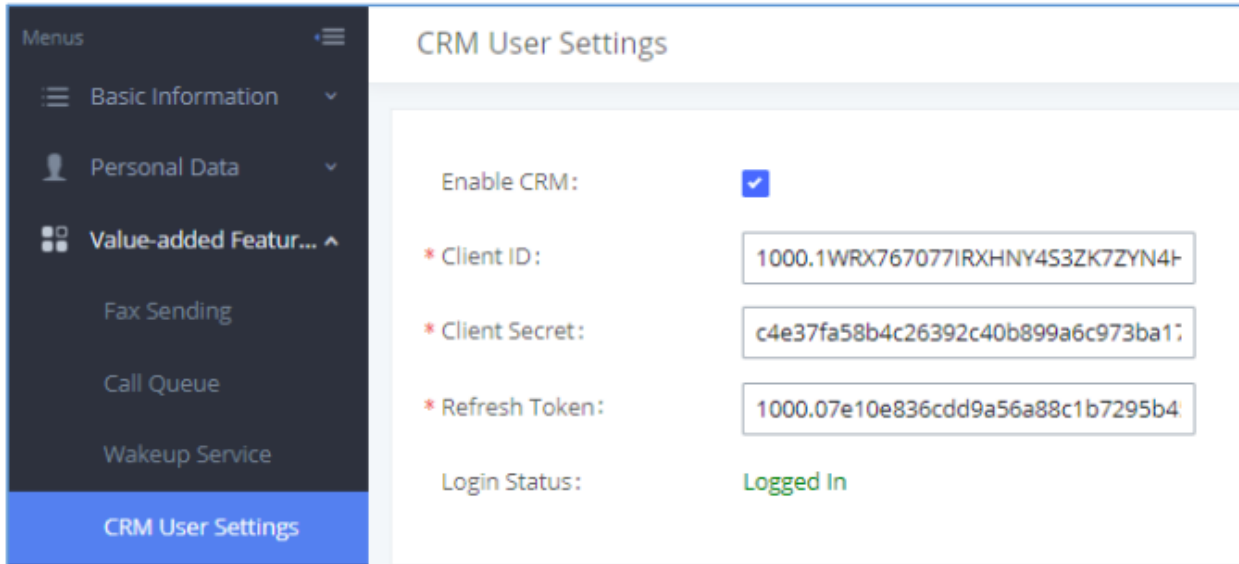


Figure 261: CRM User Settings

## Salesforce CRM

Configuration page of the Salesforce CRM can be accessed via admin login, on the UCM Web GUI→**Value-added Features**→**CRM**”.

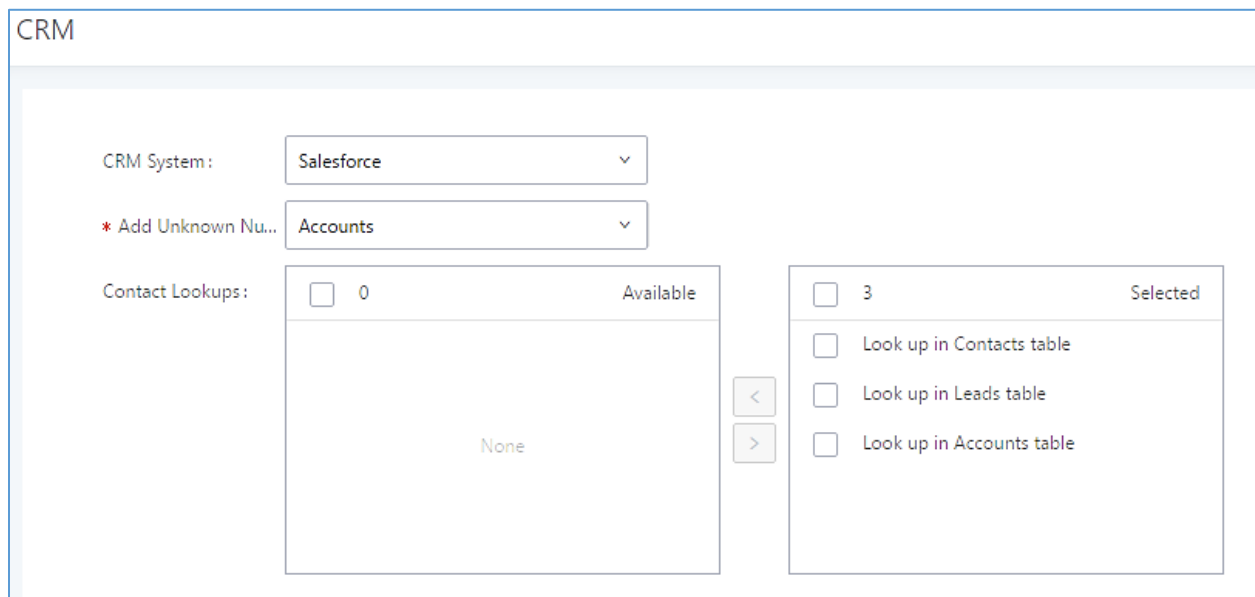




Figure 262: Salesforce Basic Settings

1. Select “Salesforce” from the CRM System Dropdown in order to use Salesforce CRM.

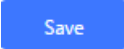
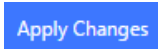


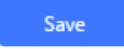
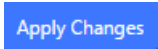


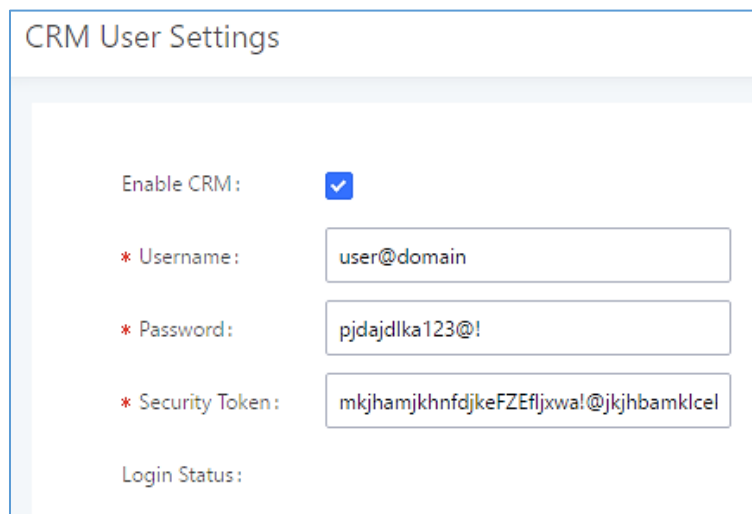
**Table 131: Salesforce Settings**

<b>CRM System</b>	Select a CRM system from the dropdown menu, four CRM systems are available: SugarCRM, vTigerCRM, ZohoCRM (legacy v1 API), ZohoCRM (v2 API), Salesforce or ACT! CRM.
<b>Add Unknown Number</b>	Add the new number to this module if it cannot be found in the selected module.
<b>Contact Lookups</b>	Select from the “ <b>Available</b> ” list of lookups and press   to select where the UCM can perform the lookups on the CRM tables, Leads, Accounts, and Contacts.

Once settings on admin access are configured:

2. Click on  and .
3. Logout from admin access.
4. Login to the UCM as user and navigate under “User Portal→Value-added Feature→CRM User Settings”.

Click on “**Enable CRM**” and enter the **username**, **password** and **Security Token** associated with the CRM account then click on  and . The status will change from “Logged Out” to “Logged In”. User can start then using Salesforce CRM features.



The screenshot shows the 'CRM User Settings' interface. It includes a form with the following fields:

- Enable CRM:** A checkbox that is checked.
- \* Username:** A text input field containing 'user@domain'.
- \* Password:** A text input field containing 'pjdajdlka123@!'.
- \* Security Token:** A text input field containing 'mkjhamjkhndjkeFZEfljxwa!@jkjhbamklcel'.
- Login Status:** A label indicating the current login status.

**Figure 263: Salesforce User Settings**

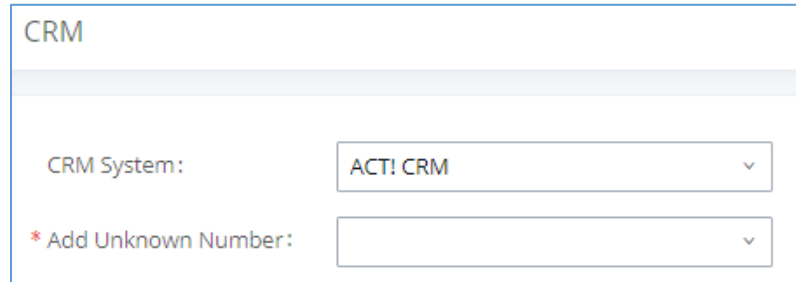
## ACT! CRM

Configuration page of the ACT! CRM can be accessed via admin login, on the UCM Web GUI→**Value-added Features→CRM**”.



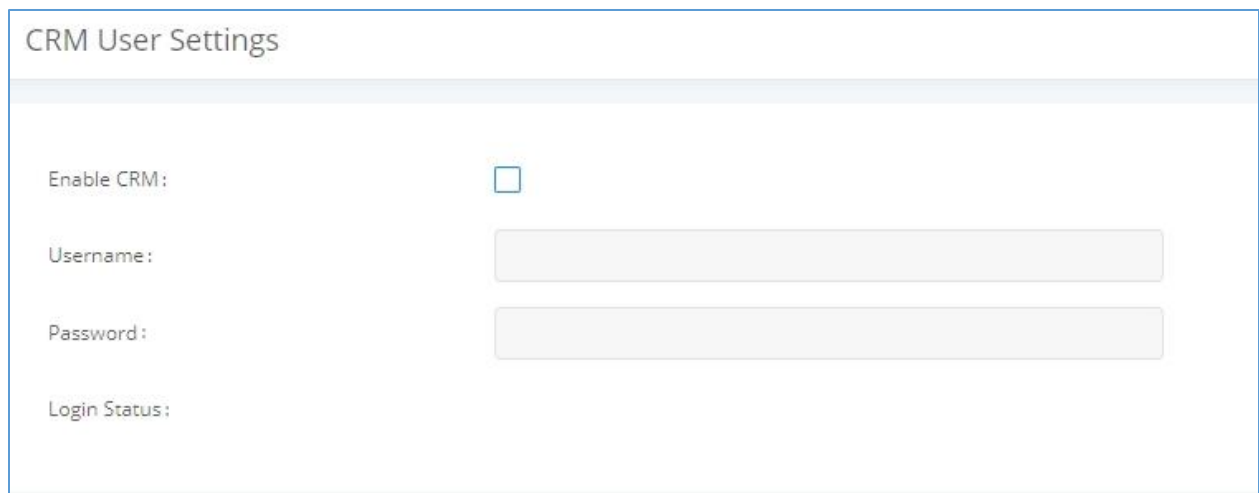
The configuration steps of the ACT! CRM are as follows:

1. Navigate to **Value-Added Features** → **CRM** and select the “ACT! CRM” option.



**Figure 264: Enabling ACT! CRM**

2. Log into the UCM as a regular user and navigate to **Value-Added Features** → **CRM User Settings** and check “Enable CRM” option and enter the username and password, which will be the ACT! CRM account’s **API Key** and **Developer Key** respectively. To obtain these, please refer to the ACT! CRM API developer’s guide here: <https://mycloud.act.com/act/Help>



**Figure 265: Enabling CRM on the User Portal**

**Note:** For more information on the ACT! CRM integration, please refer to the ACT! CRM documentation on our website.



## PMS INTEGRATION

UCM6510 supports Hotel Property Management System PMS, including check-in/check-out services, wakeup calls, room status, Do Not Disturb which provide an ease of management for hotel applications. This feature can be found on Web GUI→**Value-added Features**→**PMS**.

**Note:** The PMS integration on UCM is currently supported only with one of the three following solutions.

The PMS module built-in the UCM supports the following features based on each solution:

**Table 132: PMS Supported Features**

Feature	Mitel	HMobile	HSC	PMS API
Check-In	✓	✓	✗	✓
Check-out	✓	✓	✗	✓
Wake-up Call	✓	✓	✗	✓
Name Change	✓	✗	✓	✗
Update	✗	✓	✗	✓
Set Credit	✓	✗	✗	✗
Set Station Restriction	✓	✗	✓	✗
Room Status	✗	✓	✗	✗
Room Move	✗	✓	✗	✓
Do Not Disturb	✗	✓	✓	✗
Mini Bar	✗	✓	✗	✗
MSG	✗	✓	✗	✗
MWI	✗	✗	✓	✗
Unconditional Call Forward	✗	✗	✓	✗

### HMobile PMS Connector

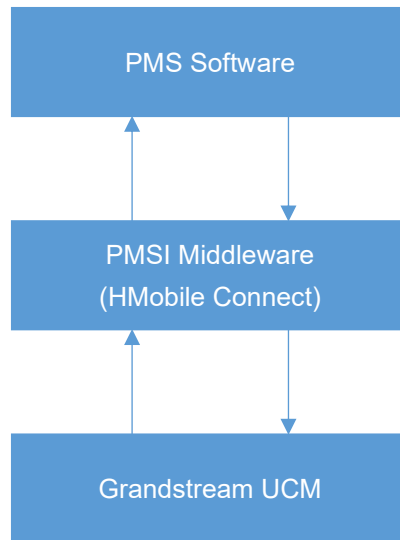
In this mode, the system can be divided into three parts:

- PMS (Property Management System)
- PMSI (Property Management System Interface)
- PBX

Grandstream UCM6XXX series have integrated HMobile Connect PMSI which supports a large variety of PMS software providing following hospitality features: Check-in, Check-out, set Room Status, Wake-up call and more.



The following figure illustrates the communication flow between the PBX (Grandstream UCM6xxx Series) and PMS software, which is done through a middleware system (HMobile Connect) acting as interface between both parties.



**Figure 266: UCM & PMS interaction**

## HSC PMS

In this mode, the system can be divided into two parts:

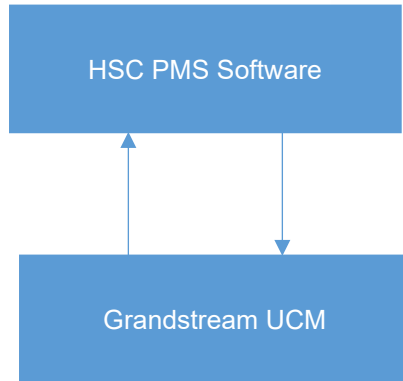
- PMS (Property Management System)
- PBX

Grandstream UCM6XXX series have integrated HSC PMS providing following features:

- Changing Display Name
- Set Station Restriction
- Call forwarding
- DND
- Name Change
- MWI

The following figure illustrates the communication flow between the PBX (Grandstream UCM6xxx Series) and PMS software (HSC). The communication between both parties is direct with no middleware.





**Figure 267: UCM & HSC PMS interaction**

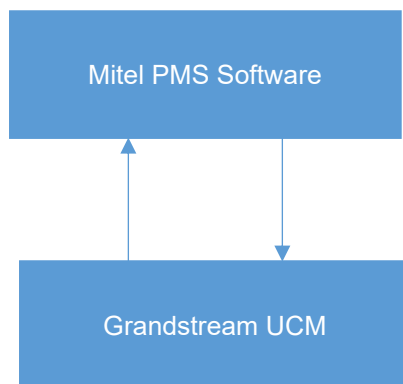
## Mitel PMS

In this mode, the system can be divided into two parts:

- PMS (Property Management System)
- PBX

Grandstream UCM6XXX series have integrated Mitel PMS providing following hospitality features: Check-in, Check-out, set Room Status, Wake-up call and more.

The following figure illustrates the communication flow between the PBX (Grandstream UCM6xxx Series) and PMS software (Mitel). The communication between both parties is direct with no middleware.



**Figure 268: UCM & Mitel PMS interaction**

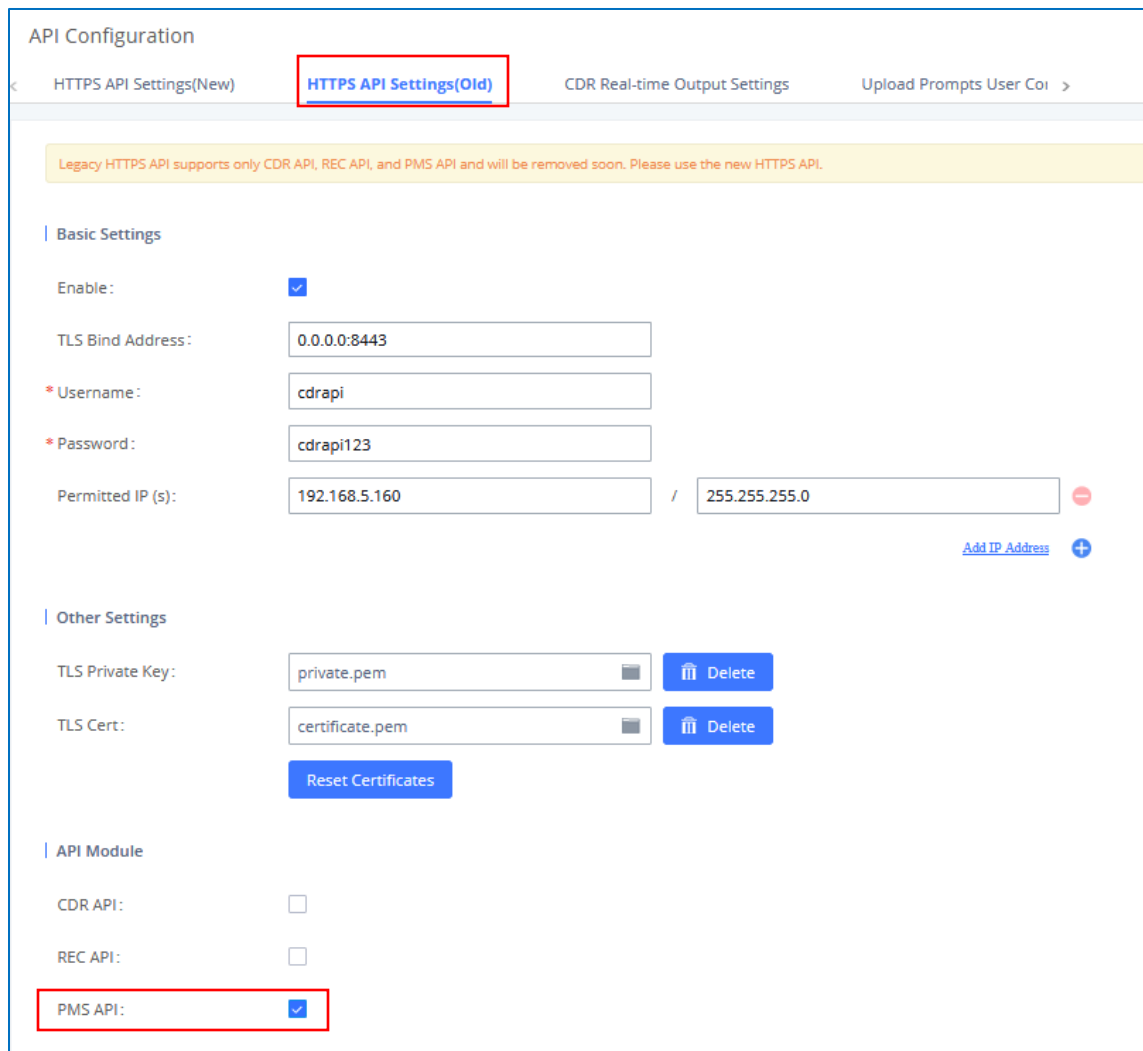


## PMS API

The PMS API allows users to use their own middleware to work with PMS systems instead of currently supported integrations.

Additionally, this API allows access to read and modify certain UCM parameters that current supported PMS integrations cannot. To use this, users must first enable and configure the HTTPS API settings.

On the “Old” HTTPS API settings, permitted IP addresses must be configured. Otherwise, the API will be inaccessible. Make sure to check “Enable PMS API”.



API Configuration

[HTTPS API Settings\(New\)](#)
HTTPS API Settings(Old)
[CDR Real-time Output Settings](#)
[Upload Prompts User Coi >](#)

Legacy HTTPS API supports only CDR API, REC API, and PMS API and will be removed soon. Please use the new HTTPS API.

**Basic Settings**

Enable:

TLS Bind Address:

\* Username:

\* Password:

Permitted IP (s):  /  [Add IP Address](#) +

**Other Settings**

TLS Private Key:  [Delete](#)

TLS Cert:  [Delete](#)

[Reset Certificates](#)

**API Module**

CDR API:

REC API:

PMS API:

**Figure 269: Enable PMSAPI**

On the “New” HTTPS API, users only need to enable the HTTPS API, which has PMS API functionality built in.

For more details, regarding Old/New HTTPS API, please refer to [API CONFIGURATION].



For more details, please refer to online [PMS API Guide](#).

## Connecting to PMS

On the UCM WebGUI→**Value-added Features**→**PMS**→**Basic Settings**” set the connection information for the PMS platform.

Table 133: PMS Basic Settings

Field	Description
<b>PMS Module</b>	Users can select the desired PMS module from the drop-down list. <ul style="list-style-type: none"> <li>• Hmobile.</li> <li>• Mitel.</li> <li>• HSC.</li> <li>• PMS API</li> </ul>
<b>Wake Up Prompt</b>	Prompt used when answering the wakeup calls it can be customized from <b>“PBX Settings→Voice Prompt→Custom Prompt</b> .
<b>PMS URL</b>	Enter the PMS system URL. If using “Hmobile” PMS Module only.
<b>UCM Port</b>	Enter the Port used by the PMS system. Default is 8081.
<b>Username</b>	Enter the Username to connect to the PMS system. If using “Hmobile” or “HSC” PMS Module only.
<b>Password</b>	Enter the password to connect to the PMS system. If using “Hmobile” or “HSC” PMS Module only.
<b>Site</b>	Enter the site to connect to the PMS system. If using “Hmobile” PMS Module only.
<b>Back Up Voicemail Recordings</b>	If enabled, this option allows backing up voicemail recordings to external storage after check-out. Voicemail can be backed up to SD card, USB disk, NAS, or an SFTP server
<b>Email address</b>	Configure the email address to send the backup to.

In order to use some PMS features please activate the feature code associated under **“Call Features→Feature Codes”**

- Update PMS Room Status
- PMS Wake Up Service



## PMS Features

### Room Status

User can create Rooms by clicking on [+ Create New Room](#), the following Figure will be displayed then.

#### Create New Room

\* Address:

\* Room Number:

\* Extension:

Guest Account:

Guest Category Cod...

Guest Credit Money...

Maid Code:

Arrival Date:

Departure Date:

**Figure 270: Create New Room**

Click “Save” to create the new room, the fields above can be configured from the PMS platform, once set the following screen will be shown:

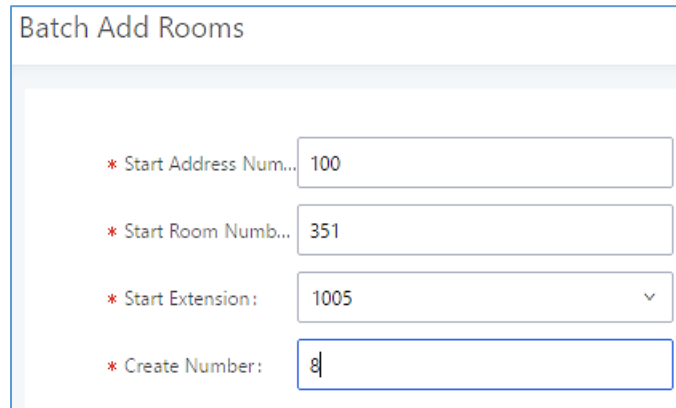
PMS									
Basic Settings		Room Status	Wakeup Service	Mini Bar	Maid				
<span style="background-color: #007bff; color: white; padding: 2px 5px; border-radius: 3px;">+ Add Room</span> <span style="margin-left: 10px;"> Delete Selected Rooms</span> <span style="background-color: #007bff; color: white; padding: 2px 5px; border-radius: 3px; margin-left: 10px;">+ Batch Add Rooms</span>									
<input type="checkbox"/>	ADDRESS ↕	ROOM NUMBER ↕	EXTENSION ↕	ROOM STATUS ↕	USER NAME ↕	GUEST CATEGORY CODE ↕	ARRIVAL DATE ↕	DEPARTURE DATE ↕	OPTIONS
<input type="checkbox"/>	10	10	1000	Check-out	John DOE				
<input type="checkbox"/>	100	100	1001	Check-out	Meryem Gou				

**Figure 271: Room Status**





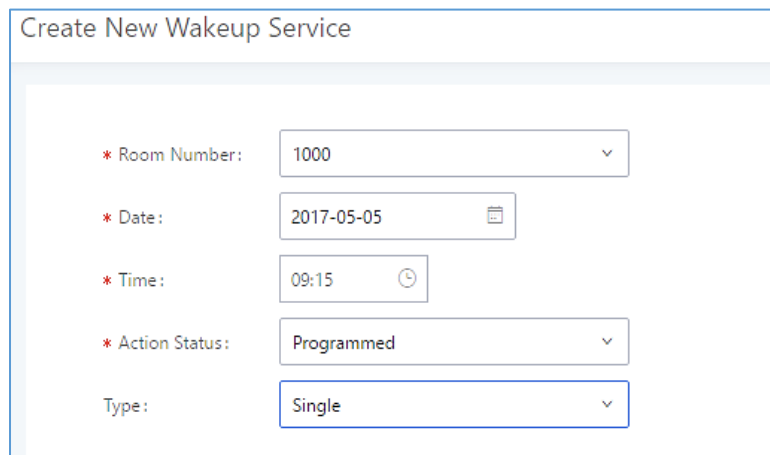
User can create a batch of rooms as well by clicking on [+ Batch Add Rooms](#). The following window will pop up:



**Figure 272: Add batch rooms**

## Wake Up Service

To create a New Wake up service, user can click on [+ Create New Wakeup Service](#). The following window will pop up:



**Figure 273: Create New Wake Up Service**



**Table 134: PMS Wake up Service**

Field	Description
<b>Room Number</b>	Select the room to create the wakeup service for.
<b>Time</b>	Set the time of the wakeup call
<b>Action Status</b>	Status of the call: <ul style="list-style-type: none"> <li><u>Programmed</u>: the call is scheduled for the time set</li> <li><u>Cancelled</u>: the call is canceled</li> </ul>



	<ul style="list-style-type: none"> <li>• <u>Executed</u>: the wakeup call has been sent.</li> </ul> <p><b>Note:</b> Editing an already executed wakeup service will automatically change the service’s status to “Programmed”.</p>
<b>Type</b>	<ul style="list-style-type: none"> <li>• <u>Single</u>: The call will be made once at specified time.</li> <li>• <u>Daily</u>: The call will be repeated every day at specified time</li> </ul>


Once the call is made on the time specified, the following figure show the status of the wakeup call.

<input type="checkbox"/>	Name ↕	Extension ↕	Status	Action Status ↕	Answer Status ↕	Date	Time	Options
<input type="checkbox"/>	John	1000	Enabled	Executed	Answered	2017-05-04	05:18	 

**Figure 274: Wakeup Call executed**

This call has been executed and answered, that why we can see the “**Answered**” status.

## Mini Bar

In order to create a new mini bar, click on  under UCM webGUI→**Value-added Features**→**PMS**→**Mini Bar**, the following window will pop up:

**Create New Mini Bar**

\* Code:

\* Name:

\* Prompt:  Prompt

Skip Maid and Passw...

Enable Continuous M...

**Figure 275: Create New Mini Bar**

**Table 135: Create New Mini Bar**

<b>Code</b>	Enter a non-existing extension number to be dialed when using the mini bar feature.
<b>Name</b>	Enter a name for the mini bar.

<b>Prompt</b>	Select the Prompt to play once connected to the mini bar.
<b>Skip Maid and Password Authentication</b>	If enabled, the default maid code will be 0000, no authentication is required. (Enter 0000 followed by # to access the consumer goods)
<b>Enable Continuous Multi Goods Billing</b>	If enabled, please separate the goods' codes by*.

In order to create a new maid, click on [+ Create New Maid](#) under UCM webGUI → **Value-added Features** → **PMS** → **Mini Bar**, the following window will popup.



**Figure 276: Create New Maid**

**Table 136: Create New Maid**

<b>Maid Code</b>	Enter the Code to use when the maid wants to use the Mini Bar.
<b>Secret</b>	Enter the password associated with the maid.

In order to create a new consumer goods, click on [+ Create New Consumer Goods](#) under UCM webGUI → **Value-added Features** → **PMS** → **Mini Bar**, the following window will popup.

### Create New Consumer Goods

\* Code:

\* Name:

**Figure 277: Create New Consumer Goods**

<b>Code</b>	Enter the Goods Code.
<b>Name</b>	Enter the Name of the Goods

The Minibar page displays as:

PMS

Basic Settings   Room Status   Wakeup Service   Mini Bar

+ Create New Mini Bar

Code ↕	Name ↕	Options
4000	MiniBar	

+ Create New Maid

Maid Code ↕	Secret	Options
1100	123456	

Total: 1   < 1 >

10 条/页   跳至 1 页

+ Create New Consumer Goods

Code ↕	Name ↕	Options
7000	mineral_water	

Total: 1   < 1 >

10 条/页   跳至 1 页

**Figure 278: Mini Bar**



## WAKEUP SERVICE

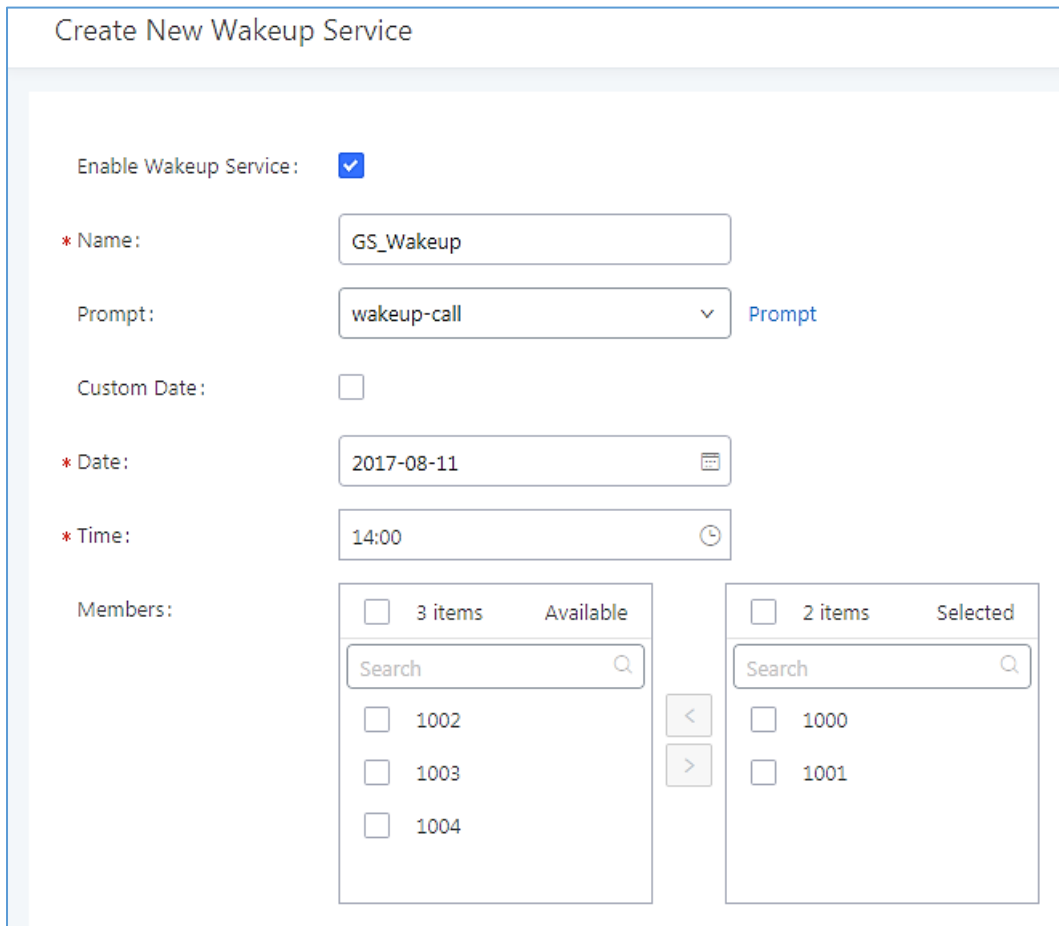
The Wakeup service can be used to schedule a reminder/wakeup calls to extensions.

There are three ways to set up Wakeup Service:

- Using admin portal
- Using user portal
- Using feature code

### Wakeup Service using Admin Login

1. Log in to the UCM as admin.
2. Wakeup service can be found under Web GUI→**Value-added Features**→**Wakeup Service**, click on **+ Create New Wakeup Service** to create a new wakeup service. The following window will popup.



**Create New Wakeup Service**

Enable Wakeup Service:

\* Name:

Prompt:  Prompt

Custom Date:

\* Date:

\* Time:

Members:

Available	Selected
<input type="checkbox"/> 3 items <input type="text" value="Search"/>	<input type="checkbox"/> 2 items <input type="text" value="Search"/>
<input type="checkbox"/> 1002 <input type="checkbox"/> 1003 <input type="checkbox"/> 1004	<input type="checkbox"/> 1000 <input type="checkbox"/> 1001

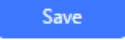
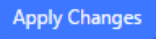
**Figure 279: Create New Wakeup Service – Admin Login**

3. Fill out the required fields and select the members to add to the wakeup group.



**Table 137: Wakeup Service – Admin Login**

<b>Enable Wakeup Service</b>	Enable Wakeup service.
<b>Name</b>	Enter a name (up to 64 characters) to identify the wakeup service.
<b>Prompt</b>	Select the prompt to play upon answering the wakeup call..
<b>Custom Date</b>	If disabled, users can select a specific date and time. If enabled users can select multiple days of the week to perform the wakeup.
<b>Date</b>	Select the date or dates when to performs the wakeup call.
<b>Time</b>	Select the time when to send the wakeup call.
<b>Members</b>	Select the extensions to send the wakeup call to.

4. Click  and  to apply the changes.

A wakeup service entry is created. The UCM will send a wakeup call to every extension in the member list at the scheduled date and time.

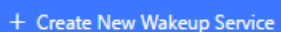
**Note:** The wakeup service has the following limitation on how many members can be added depending on UCM model.

**Table 138: Max Wakeup Members**

UCM Model	Max members in a Wakeup Service
UCM6202	50
UCM6204	50
UCM6208	100
UCM6510	100

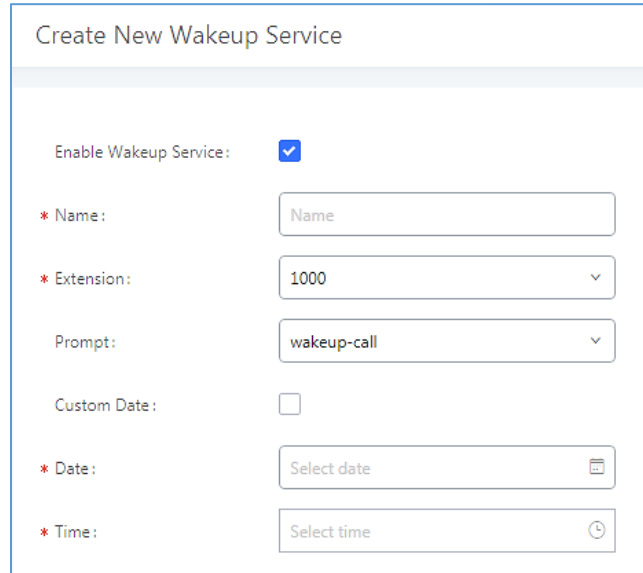
## Wakeup Service from User Portal

1. Log into the UCM user portal.
2. Wakeup service can be found under “Value-added Features→Wakeup Service”, click on



to create a new wakeup service.





Create New Wakeup Service

Enable Wakeup Service:

\* Name:

\* Extension:

Prompt:

Custom Date:

\* Date:

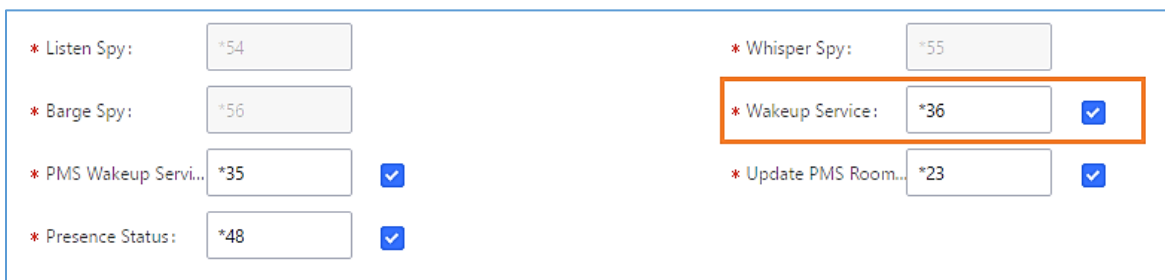
\* Time:

**Figure 280: Create New Wakeup Service – User Portal**

- Configure the Name, Prompt, Date and Time for the wakeup call
- Click **Save** and **Apply Changes** to apply the changes. A wakeup service entry is created. The UCM will send a wakeup call at the scheduled date and time.

## Wakeup Service using Feature Code

- Log into the UCM admin portal.
- Enable “Wakeup Service” from the WebGUI under the Call Features→Feature Codes→Feature Codes page.



* Listen Spy:	<input type="text" value="*54"/>	
* Barge Spy:	<input type="text" value="*56"/>	
* PMS Wakeup Servi...	<input type="text" value="*35"/>	<input checked="" type="checkbox"/>
* Presence Status:	<input type="text" value="*48"/>	<input checked="" type="checkbox"/>
* Whisper Spy:	<input type="text" value="*55"/>	
* Wakeup Service:	<input type="text" value="*36"/>	<input checked="" type="checkbox"/>
* Update PMS Room...	<input type="text" value="*23"/>	<input checked="" type="checkbox"/>

**Figure 281: Wakeup Service Feature Code**

- Click **Save** and **Apply Changes** to apply the changes.
- Dial the Wakeup Service feature code (\*36 by default) to access to the UCM wakeup service.
- Users have the choice to set a wakeup service for tomorrow or specify another day when adding a wakeup service.
- A wakeup service entry is created. The UCM will send a wakeup call at the scheduled date and time.



## ANNOUNCEMENTS CENTER

Starting from firmware 1.0.2.7, UCM supports Announcement Center functionality. By dialing a code associated with a custom prompt along with a configured Announcement Group number, users can quickly send audio prompts to specified groups of extensions.

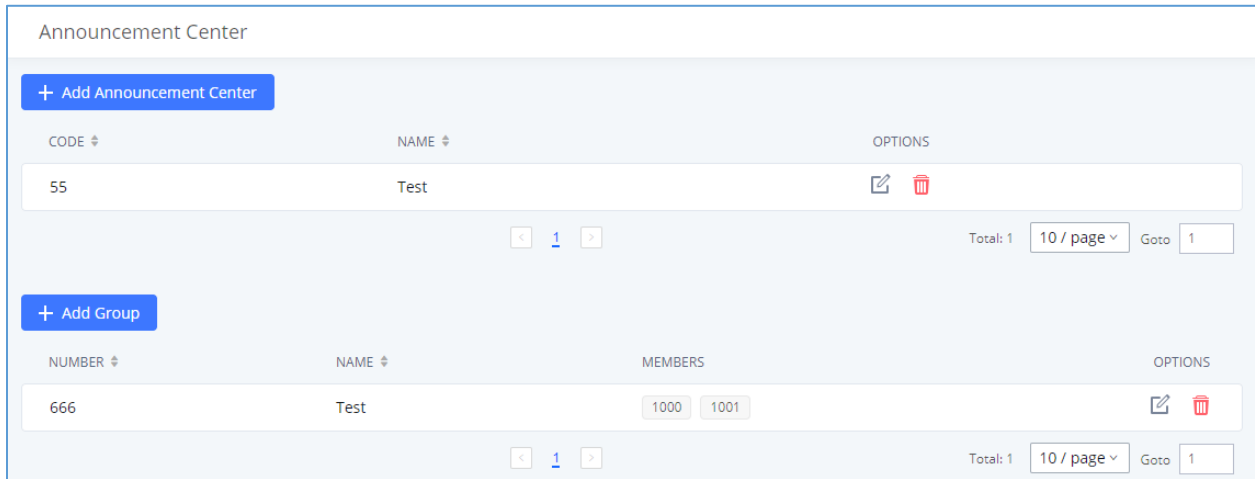


Figure 282: Announcements Center

### Announcements Center Setting

Table 139: Announcements Center Setting

<b>Name</b>	Configure a name for the Announcements Center.
<b>Code</b>	Enter a code number to associate the audio prompt with. This code will be used in combination with the Group Number. Example: If the code is 55, and the group number is 666, dialing 66555 will send the prompt associated with code 55 to all the members of Group 666. Note: The combined number must not conflict with any existing extension on the UCM.
<b>Custom Prompt</b>	Configures the custom prompt to play to announcement group members. Prompts can be directly uploaded from this page. Note: Prompt filenames cannot exceed 100 characters.
<b>Ring Timeout</b>	Configure the ring timeout for the group members. The default value is 30 seconds.






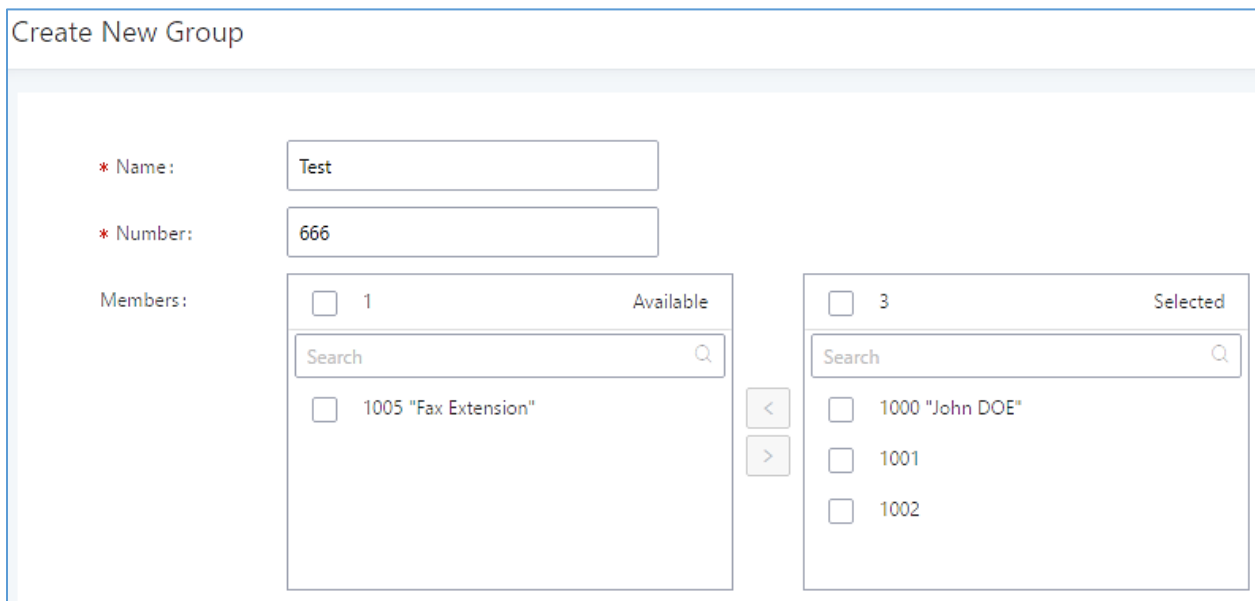
## Group Setting

**Table 140: Group Setting**

<b>Name</b>	Configure a name for the Announcement group <b>Note:</b> Name cannot exceed 64 characters.
<b>Number</b>	Configure the group number. The group number is used in combination with code. For example, if group number is 666, and code is 55. User dials 55666 will send prompt 55 to all members in group 666.  <b>Note:</b> The group number must not conflict with any other numbers, such as extension or conference number and cannot exceed 64 characters.

Announcements Center feature can be found under Web GUI → **Value-added Features** → **Announcements Center**. The following example demonstrates the usage of this feature.

1. Click  to create new group.
2. Configure a name and number for the group.
3. Select the extensions that will be in the group.



**Create New Group**

\* Name:

\* Number:

Members:

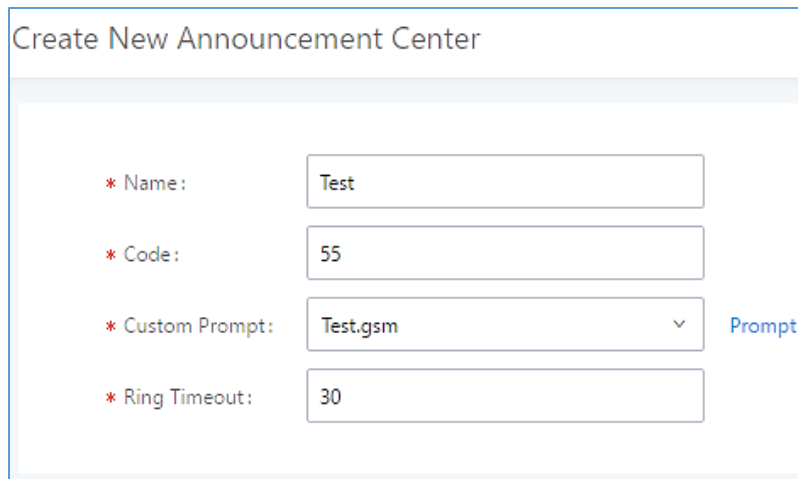
Available	Selected
<input type="checkbox"/> 1 <input type="checkbox"/> 1005 "Fax Extension"	<input type="checkbox"/> 3 <input type="checkbox"/> 1000 "John DOE" <input type="checkbox"/> 1001 <input type="checkbox"/> 1002

**Figure 283: Announcements Center Group Configuration**

Here, Group Test's number is 666 and has extensions 1000, 1001, and 1002 as members of the group.



1. Click [+ Add Announcement Center](#) to create a new Announcement Center.
2. Configure the Announcement Center name and code to associate with the custom prompt.
3. Select the audio prompt that will be associated with the configured code. Users can directly upload audio prompts to use from this page.



Create New Announcement Center

\* Name :

\* Code :

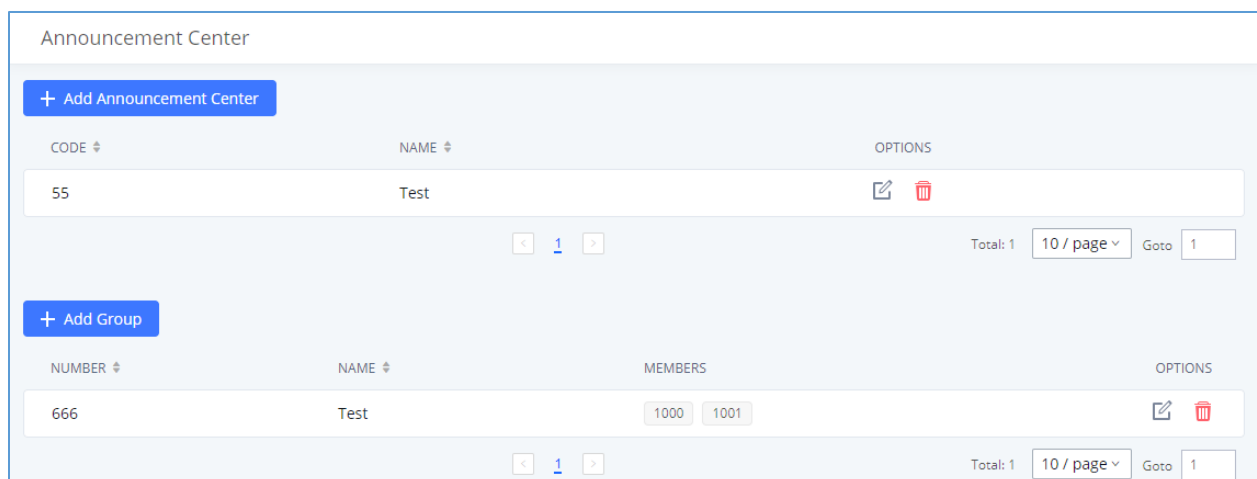
\* Custom Prompt:  Prompt

\* Ring Timeout:

**Figure 284: Announcements Center Code Configuration**

Code and Group number are used together to direct specified message to the target group. All extensions in the group will received the message. For example, in this example, we can send code 55 to group 666.

Sending 55 (code) + 666 (group number) will send an announcement with the associated audio prompt to all the members of Group Test.



Announcement Center

[+ Add Announcement Center](#)

CODE	NAME	OPTIONS
55	Test	

Total: 1 | 10 / page | Goto 1

[+ Add Group](#)

NUMBER	NAME	MEMBERS	OPTIONS
666	Test	1000 1001	

Total: 1 | 10 / page | Goto 1

**Figure 285: Announcements Center example**

## QUEUEMETRICS INTEGRATION

The UCM now supports QueueMetrics, a highly scalable monitoring and reporting suite that addresses the needs of thousands of call centers worldwide and offers a broad range of benefits and services.

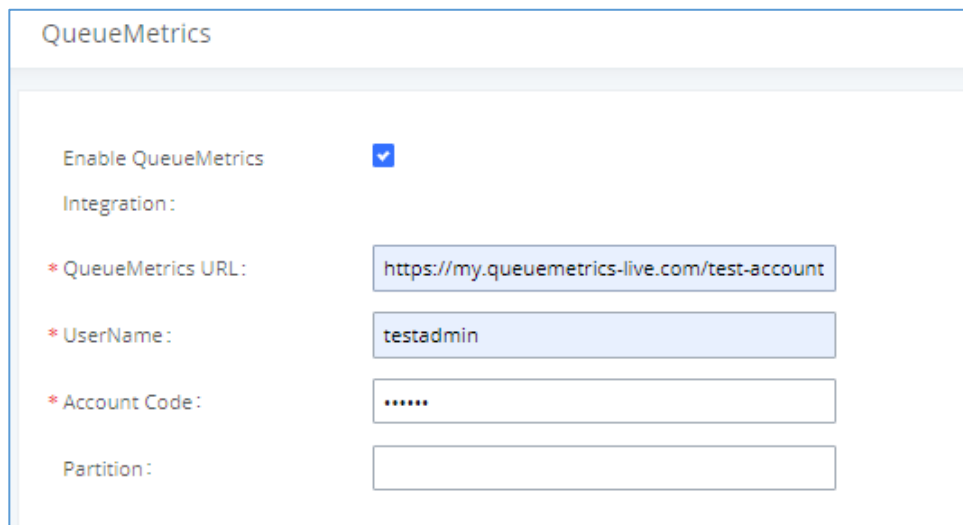
UCM currently supports the following features with QueueMetrics: Agent login, Agent Logoff, Realtime Monitoring-Pausing, Realtime Monitoring-Barging, Realtime Monitoring-Transferring, Realtime Monitoring-End calls, Generating Performance Report-Quick and Agent today.

### API Configuration Parameters

Configuration page of the QueueMetrics can be accessed via admin login, on the UCM Web GUI→**Value-added Features**→**QueueMetrics**.

To Integrate QueueMetrics with the UCM, please follow the steps below:

1. Enable the option QueueMetrics Integration.
2. Enter the QueueMetrics URL provided.
3. Set the Username and the account code to the account name and password provided from QueueMetrics.
4. Click on Save and Apply Changes.



QueueMetrics

Enable QueueMetrics

Integration:

\* QueueMetrics URL:

\* UserName:

\* Account Code:

Partition:

Figure 286: QueueMetrics configuration



**Table 141: QueueMetrics Configuration Parameters**

<b>QueueMetrics</b>	
<b>Enable QueueMetrics Integration</b>	Enable/Disable QueueMetrics Integration.
<b>QueueMetrics URL</b>	Configure the URL for QueueMetrics Integration.
<b>Username</b>	Configure the username for QueueMetrics authentication.
<b>Account Code</b>	Configure the password for QueueMetrics authentication.
<b>Partition</b>	Configure Data storage partition identifier.

For more details, please refer to online guide:

[http://www.grandstream.com/sites/default/files/Resources/QueueMetrics\\_integration.pdf](http://www.grandstream.com/sites/default/files/Resources/QueueMetrics_integration.pdf)



# STATUS AND REPORTING

## PBX Status

The UCM Dashboard page under **System Status**→**Dashboard** provides a real-time overview of the system's trunks, extensions, queues, conference rooms, interface status, digital channels, and parking lots.

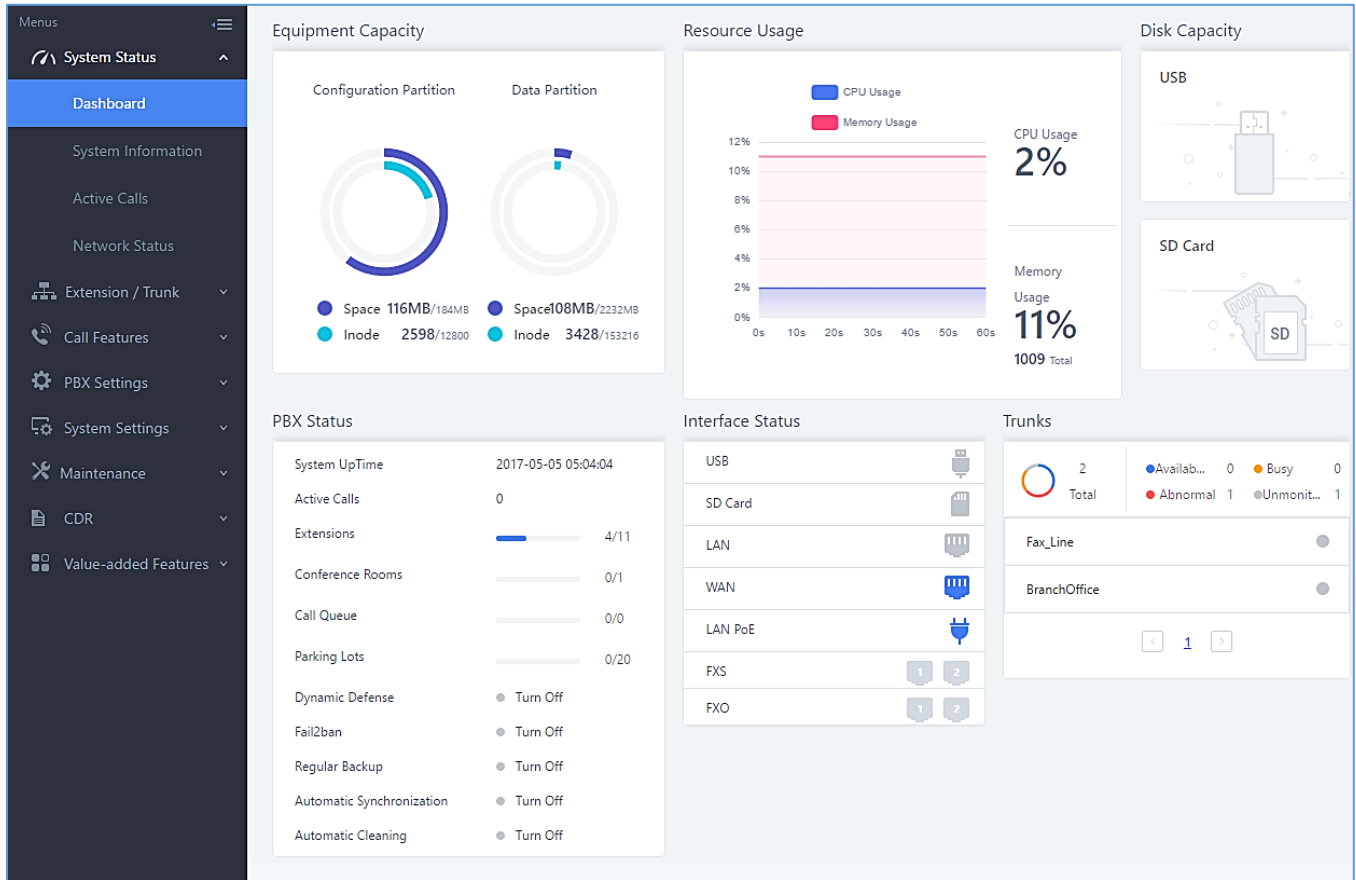


Figure 287: Status→PBX Status

## Trunks

Users can see the status of all configured trunks.



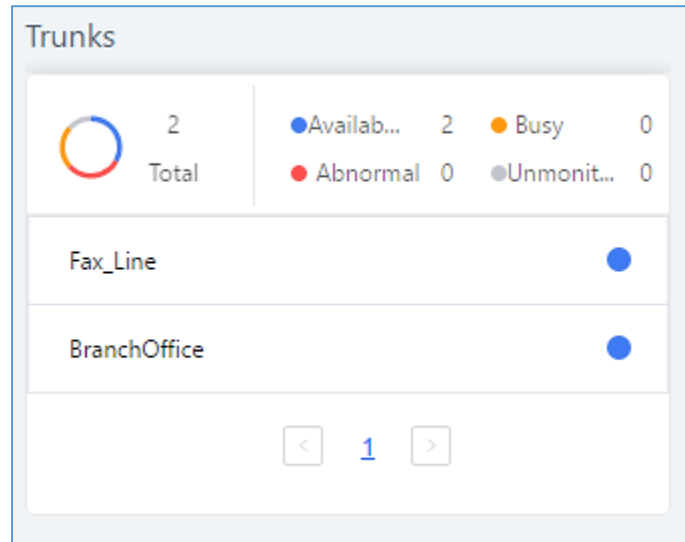


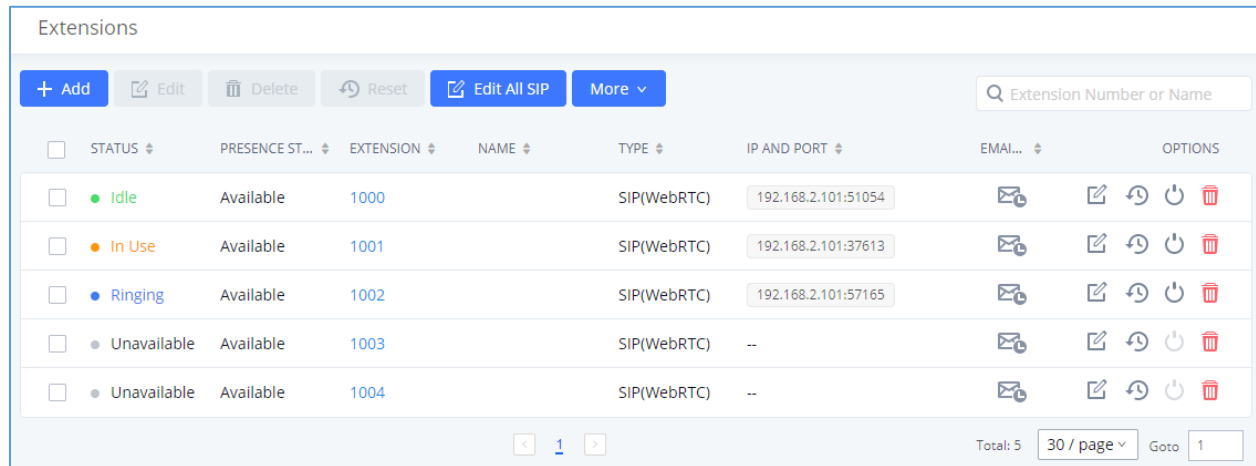
Figure 288: Trunk Status

Table 142: Trunk Status

<b>Status</b>	Display trunk status. <ul style="list-style-type: none"> <li>Analog trunk/Digital trunk status:             <ul style="list-style-type: none"> <li><b>Available</b></li> <li><b>Busy</b></li> <li><b>Unavailable</b></li> <li><b>Unknown Error</b></li> <li><b>Error Configured:</b> Incorrect signaling configuration between the two devices. For example, both of the devices are configured as CPE or NET.</li> </ul> </li> <li>SIP Peer trunk status:             <ul style="list-style-type: none"> <li><b>Unreachable:</b> The hostname cannot be reached.</li> <li><b>Unmonitored:</b> This requires "Keep-alive" to be enabled for the trunk, not the QUALIFY feature.</li> <li><b>Reachable:</b> The hostname can be reached.</li> </ul> </li> <li>SIP Register trunk status:             <ul style="list-style-type: none"> <li><b>Registered</b></li> <li><b>Unrecognized Trunk</b></li> </ul> </li> </ul>
<b>Trunks</b>	Display trunk name
<b>Type</b>	Display trunk Type: <ul style="list-style-type: none"> <li>Analog</li> <li>E1/T1/J1</li> <li>SIP</li> <li>IAX</li> </ul>
<b>Username</b>	Display username for this trunk.
<b>Port/Hostname/IP</b>	Display Port for analog trunk, or Hostname/IP for VoIP (SIP/IAX) trunk.

## Extensions

Extensions Status can be seen from the same configuration page, users can go under Web GUI→**Extension/Trunk**→**Extensions** and following page will be displayed listing the extensions and their status information.



STATUS	PRESENCE ST...	EXTENSION	NAME	TYPE	IP AND PORT	EMAIL...	OPTIONS
Idle	Available	1000		SIP(WebRTC)	192.168.2.101:51054		
In Use	Available	1001		SIP(WebRTC)	192.168.2.101:37613		
Ringing	Available	1002		SIP(WebRTC)	192.168.2.101:57165		
Unavailable	Available	1003		SIP(WebRTC)	--		
Unavailable	Available	1004		SIP(WebRTC)	--		

**Figure 289: Extension Status**













**Table 143: Extension Status**

<b>Status</b>	Display extension number (including feature code). The color indicator has the following definitions. <ul style="list-style-type: none"> <li>● Green: Free</li> <li>● Blue: Ringing</li> <li>● Yellow: In Use</li> <li>● Grey: Unavailable</li> </ul>
<b>Presence Status</b>	Display the presence status of the extension.
<b>Extension</b>	Display the extension number.
<b>Name</b>	First name and last name of the extension.
<b>IP and Port</b>	Display the IP and port number of the registered device.
<b>Email</b>	Display Email Notification status for the extension. SIP Account email notification has not been sent. SIP Account email notification has been sent.
<b>Type</b>	Displays extension type. <ul style="list-style-type: none"> <li>● SIP User</li> <li>● IAX User</li> <li>● Analog User</li> </ul>

## Interfaces Status










This section displays interface connection status on the UCM6510 for USB, SD Card, LAN, WAN, LAN PoE, Heartbeat, Power 1, Power 2, Digital, FXS and FXO ports.



**Table 144: Interface Status Indicators**

FXO	
	Disconnected
	Connected but not configured
	Connected and idle
	Connected and in use
FXS	
	Connected but not configured
	Connected and idle
	Connected and in use
SD Card	
	SD Card plugged in
	SD Card unplugged
USB	
	USB plugged in
	USB unplugged
LAN PoE	
	PoE is used





	PoE is not used
<b>Power ½</b>	
	Power supply is working
	Power supply is abnormal
	No power supply
<b>LAN/WAN/Heartbeat</b>	
	Connected
	Not connected
<b>Digital Port T1/E1/J1</b>	
	Connected and working
	RED alarm: there is physical wiring problem, loss of connectivity, or a framing/line-coding mismatch with the remote switch.
	<p>YELLOW alarm: connected but the link is working only one-way. This means that the remote switch is not able to maintain sync with you or is not receiving your transmission.</p> <p>The following example scenarios could trigger YELLOW alarm:</p> <ol style="list-style-type: none"> <li>1. The T1 port is connected with J1 connection.</li> <li>2. Incorrect cable is used.</li> <li>3. When using E1, one end is using CRC4 while the other end is not.</li> </ol>

	<p>BLUE alarm: the port goes into BLUE alarm when it receives all unframed 1s on all timeslots from the remote switch. This is a special signal to indicate that the remote switch is having problem with its upstream connection.</p>
	<p>Cannot start up</p>

## System Status

The UCM6510 system status can be accessed via Web GUI→**System Status**, which displays the following system information.

### General

Under Web GUI→**System Status**→**System Information**→**General**, users could check the hardware and software information for the UCM6510. Please see details in the following table.

Table 145: System Status→General

System Status →System Information→General	
<b>Model</b>	Product model.
<b>Part Number</b>	Product part number.
<b>System Time</b>	Current system time. The current system time is also available on the upper right of each web page.
<b>Up Time</b>	System up time since the last reboot.
<b>Idle Time</b>	System idle time since the last reboot.
<b>Boot</b>	Boot version.
<b>Core</b>	Core version.
<b>Base</b>	Base version.
<b>Program</b>	Program version. This is the main software release version.
<b>Recovery</b>	Recovery version.

## Network

Under Web GUI→**System Status**→**System Information**→**Network**, users could check the network information for the UCM6510. Please see details in the following table.

**Table 146: System Status→Network**

System Status→System Information→Network	
<b>MAC Address</b>	Global unique ID of device, in HEX format. The MAC address can be found on the label coming with original box and on the label located on the bottom of the device.
<b>IP Address</b>	IP address.
<b>Gateway</b>	Default gateway address.
<b>Subnet Mask</b>	Subnet mask address.
<b>DNS Server</b>	DNS Server address.
<b>Speed</b>	Network Port Speed.
<b>Duplex mode</b>	Shows the Duplex Mode (Full/Half Duplex).

## Storage Usage

Users could access the storage usage information from Web GUI→**System Status**→**Dashboard** →**Space Usage**. It shows the available and used space for Space Usage and Inode Usage.

### Space Usage includes:

- Configuration partition
- This partition contains PBX system configuration files and service configuration files.
- Data partition
- Voicemail, recording files, IVR file, Music on Hold files and etc.
- USB disk
- USB disk will display if connected.
- SD Card
- SD Card will display if connected.

### Inode Usage includes:

- Configuration partition
- Data partition



**Note:** Inode is the pointer used for file reference in the system. The system usually has limited resources of pointers.

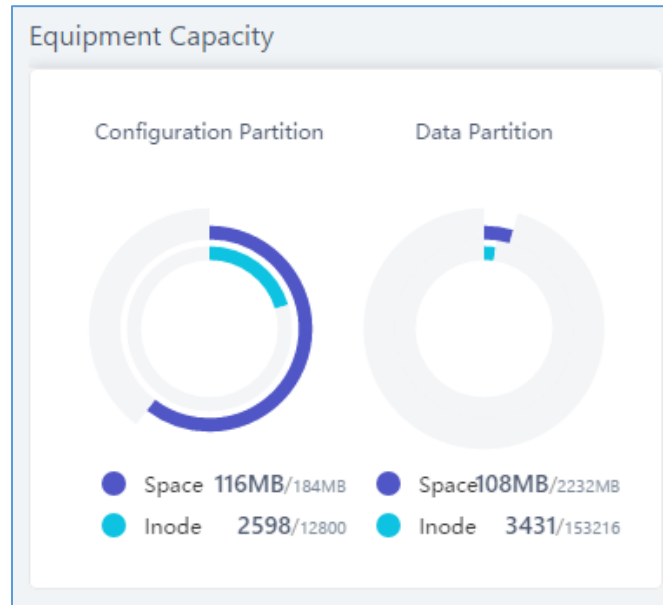


Figure 290: System Status→Storage Usage

## Resource Usage

When configuring and managing the UCM6510, users could access resource usage information to estimate the current usage and allocate the resources accordingly. Under Web GUI→**System Status**→**Dashboard**→**Resource Usage**, the current CPU usage and Memory usage are shown in the pie chart.

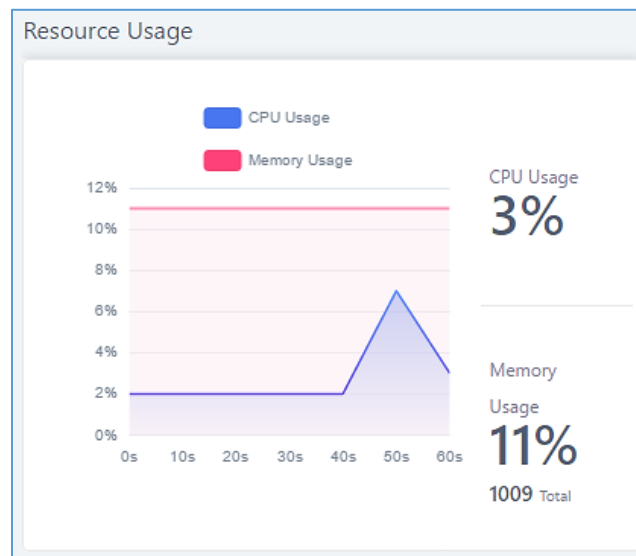


Figure 291: System Status→Resource Usage

## System Events

The UCM6510 can monitor important system events, log the alerts and send email notifications to specified email addresses.


### Alert Events List

The system alert events list can be found under Web GUI→**Maintenance**→**System Events**. The following events are currently supported on the UCM. Alerts for these events will be generated if abnormalities occur:

**Table 147: Alert Events**

Action index	Alert Events
1	Disk Usage
2	Modify Super Admin Password
3	Memory Usage
4	System Reboot
5	System Update
6	System Crash
7	Register SIP failed
8	Register SIP trunk failed
9	Restore Config
10	User login success
11	User login failed
12	SIP Internal Call Failure
13	SIP Outgoing Call through Trunk Failure
14	Fail2ban Blocking
15	SIP Lost Registration
16	SIP Peer Trunk Status
17	User Login Banned
18	External Disk Usage
19	HA failure warning
20	Emergency Calls
21	The CDR database is corrupted
22	NAS
23	Data Sync Backup



Click on  to configure the parameters for each event.

### 1. Disk Usage

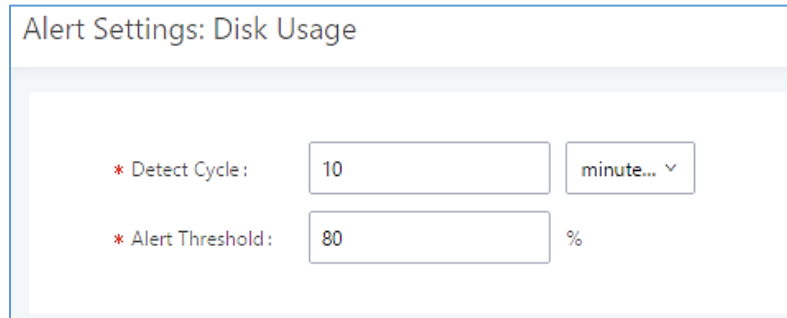


Figure 292: System Events→Alert Events Lists: Disk Usage

- **Detect Cycle:** The UCM6510 will perform the internal disk usage detection based on this cycle. Users can enter the number and then select second(s)/minute(s)/hour(s)/day(s) to configure the cycle.
- **Alert Threshold:** If the detected value exceeds the threshold (in percentage), the UCM6510 system will send the alert.

### 2. External Disk Usage

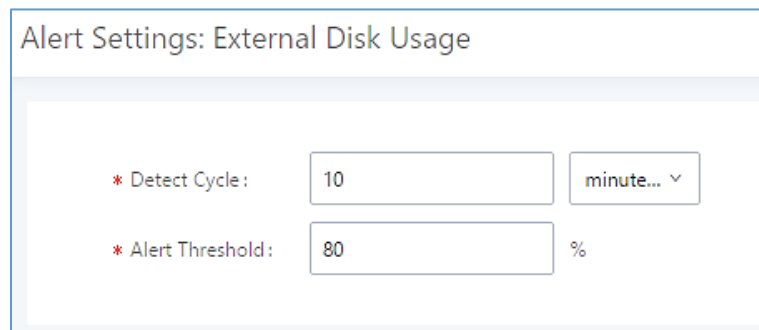
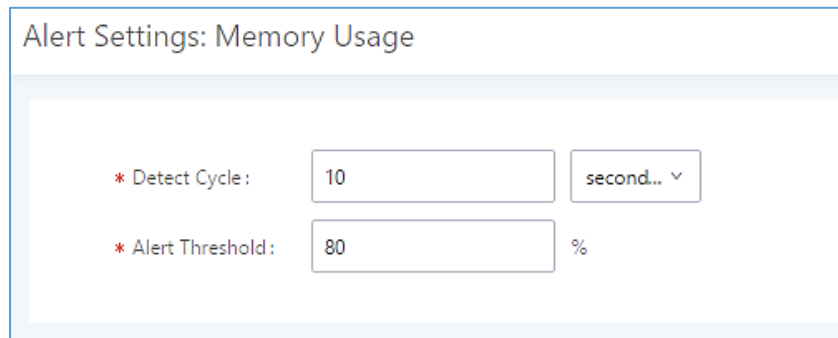


Figure 293: System Events→Alert Events Lists: External Disk Usage

- **Detect Cycle:** The UCM6510 will perform the External disk usage detection based on this cycle. Users can enter the number and then select second(s)/minute(s)/hour(s)/day(s) to configure the cycle.
- **Alert Threshold:** If the detected value exceeds the threshold (in percentage), the UCM6510 system will send the alert.



### 3. Memory Usage



Alert Settings: Memory Usage

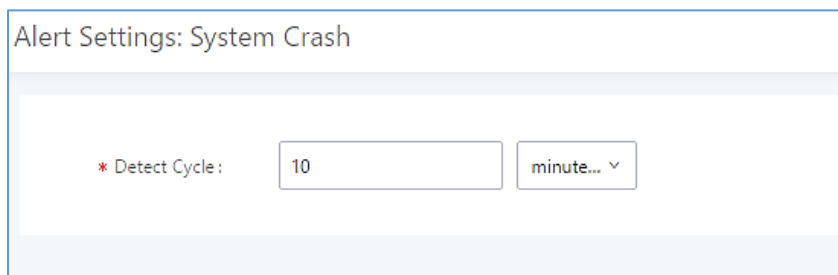
\* Detect Cycle : 10 second... ▾

\* Alert Threshold : 80 %

Figure 294: System Events→Alert Events Lists: Memory Usage

- **Detect Cycle:** The UCM6510 will perform the memory usage detection based on this cycle. Users can enter the number and then select second(s)/minute(s)/hour(s)/day(s) to configure the cycle.
- **Alert Threshold:** If the detected value exceeds the threshold (in percentage), the UCM6510 system will send the alert.

### 4. System Crash




Alert Settings: System Crash

\* Detect Cycle : 10 minute... ▾

Figure 295: System Events→Alert Events Lists: System Crash

- **Detect Cycle:** The UCM6510 will detect the event at each cycle based on the specified time. Users can enter the number and then select second(s)/minute(s)/hour(s)/day(s) to configure the cycle.

Click on the switch  to turn on/off the alert and Email notification for the event.

Users could also select the checkbox for each event and then click on button "Alert On", "Alert Off", "Email Notification On", "Email Notification Off" to control the alert and Email notification configuration.

### **Alert Log**

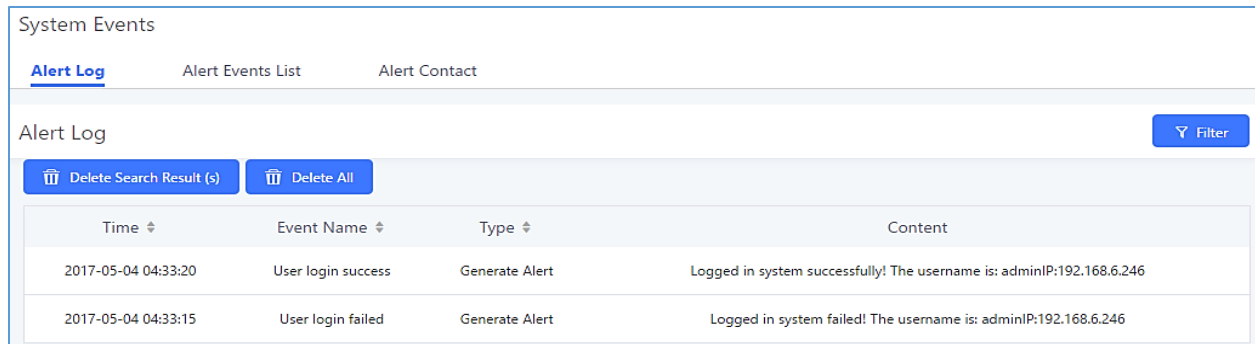
Under Web GUI→**Status**→**System Events**→**Alert Log**, system messages are listed when the alert is triggered for the configured system events. The following picture shows disk usage alert log. We can tell the detect cycle for the disk usage is 10 minutes and the disk usage is restored to normal after the administrator cleans up the disk storage below the threshold.



2013-10-09 21:32:00	Disk Usage	Generate Alert	Disk usage exceeds the threshold
2013-10-09 21:42:00	Disk Usage	Generate Alert	Disk usage exceeds the threshold
2013-10-09 21:52:00	Disk Usage	Generate Alert	Disk usage exceeds the threshold
2013-10-09 22:02:00	Disk Usage	Restore to normal	Disk usage has been restored to normal

**Figure 296: System Events→Alert Log**

The following screenshot shows system crash alert logs.



System Events

[Alert Log](#)    Alert Events List    Alert Contact

Alert Log Filter

Delete Search Result (s)    Delete All

Time	Event Name	Type	Content
2017-05-04 04:33:20	User login success	Generate Alert	Logged in system successfully! The username is: admin!IP:192.168.6.246
2017-05-04 04:33:15	User login failed	Generate Alert	Logged in system failed! The username is: admin!IP:192.168.6.246

**Figure 297: System Events→Alert Log**

User could also filter alert logs by selecting a certain event category, type of alert log, and/or specifying a certain time period. The matching results will be displayed after clicking on Filter. Alert logs are playlistified into two types by the system:

1. **Generate Alert:** Generated when alert events happen, for example, alert logs for disk usage exceeding the alert threshold.
2. **Restore to Normal:** Generated when alert events being cleared, for example, logs for disk usage dropping back below the alert threshold.

User could filter out alert logs of “Generate Alert” or “Restore to Normal” by specifying the type according to need. The following figure shows an example of filtering out alert logs of type of “Restore to Normal”.



**Alert Log**
Alert Events List
Alert Contact

Filter
Reset

Event Name:

Type:

Start Time:

End Time:

Delete Search Result (s)
Delete All

Time	Event Name	Type	Content
2017-05-04 04:33:15	User login failed	Generate Alert	Logged in system failed! The username is: adminIP:192.168.6.246

**Figure 298: Filter for Alert Log**

## Alert Contact

This feature allows the administrator to be notified when one of the Alert events mentioned above happens. Users could add administrator's Email address under Web GUI→**Maintenance**→**System Events**→**Alert Contact** to send the alert notification to an email (Up to 10 Email addresses can be added) or also specify an HTTP server where to send this alert.

**Table 148: Alert Contact**

<b>Super Admin Email</b>	Configure the email addresses to send alert notifications to. Up to 10 email addresses can be added.
<b>Admin Email</b>	Configure the email addresses to send alert notifications to. Up to 10 email addresses can be added.
<b>Email Template</b>	Please refer to section <b>Password</b>
<b>Protocol</b>	Protocol used to communicate with the server. HTTP or HTTPS. Default one is <b>HTTP</b> .
<b>HTTP Server</b>	The IP address or FQDN of the HTTP server.
<b>HTTP Server Port</b>	HTTP/HTTPS port
<b>Warning Template</b>	Customize the template used for system warnings. Default one: {"action":"\${ACTION}","mac":"\${MAC}","content":"\${WARNING_MSG}"}
<b>Notification Template</b>	Customize the notification template to receive relevant alert information. By default: <code>{"action":"\${ACTION}","cpu":"\${CPU_USED}","memory":"\${MEM_USED}","disk":"\${DISK_USED}","external_disk":"\${EXTERNAL_DISK_USED}"}</code> <b>Note:</b> The notification message with "action:0" will be sent periodically if Notification Interval is set.
<b>Notification Interval</b>	Modifies the frequency at which notifications are sent in seconds. No notifications will be sent if the value is "0". <b>Default value: 20</b>



<b>Template</b>	<code>\${MAC}</code> : MAC Address
<b>Variables</b>	<code>\${WARNING_MSG}</code> : Warning message <code>\${TIME}</code> : Current System Time <code>\${CPU_USED}</code> : CPU Usage <code>\${MEM_USED}</code> : Memory Usage <code>\${ACTION}</code> : Message Type. Refer to [Table 147: Alert Events] <code>\${DISK_USED}</code> : Disk Usage <code>\${EXTERNAL_DISK_USED}</code> : Disk Usage

## CDR

CDR (Call Detail Record) is a data record generated by the PBX that contains attributes specific to a single instance of phone call handled by the PBX. It has several data fields to provide detailed description for the call, such as phone number of the calling party, phone number of the receiving party, start time, call duration, and etc.

On the UCM6510, the CDR can be accessed under Web GUI → **CDR** → **CDR**. Users could filter the call report by specifying the date range and criteria, depending on how the users would like to include the logs to the report. Click on "Search" button to display the generated report.

**Important Note:** Starting from firmware 1.0.15.16, the UCM has **CDR separation** and it will display only CDR for the current month. To view data of the previous months, users will need to apply a filter with a specified date range.



CDR
Hide Filter ^

Start Time:

End Time:

Caller Number:

Caller Name:

Callee Number:

Account Code:

Source Trunk Name:

Destination:

Trunk Name:

Action Type:

Export File:

Data:

Extension:

Group:

Call Type:  Inbound Calls  Outbound Calls  Internal Calls  External Calls

Status:  Answered  No Answer  Busy  Failed

By default, this page displays the CDR entries from the current month. Use the "Filter" button to specify a time range.

STATUS	CALL FROM	CALL TO	ACTION TYPE	START TIME	CALL TIME	TALK TIME	ACCOUNT CODE	RECORDING FILE OPTIONS
	"1003" 1003	1000	VM	2021-01-19 09:55:52	0:00:02	0:00:02		-
	"1003" 1003	1001	DIAL	2021-01-19 09:54:42	0:00:27	0:00:00		-

**Figure 299: CDR Filter**

**Table 149: CDR Filter Criteria**


<b>Call Type</b>	<ul style="list-style-type: none"> <li><b>Inbound calls:</b> Inbound calls are calls originating from a non-internal source (like a VoIP trunk) and sent to an internal extension.</li> <li><b>Outbound calls:</b> Outbound calls are calls sent to a non-internal source (like a VoIP trunk) from an internal extension.</li> <li><b>Internal calls:</b> Internal calls are calls from one internal extension to another extension, and not sent over a trunk.</li> <li><b>External calls:</b> External calls are calls sent from one trunk to another trunk, and are not sent to any internal extension.</li> </ul>
<b>Status</b>	<p>Filter with the call status, the available statuses are the following:</p> <ul style="list-style-type: none"> <li>Answered</li> <li>No Answer</li> <li>Busy</li> <li>Failed</li> </ul>
<b>Source Trunk Name</b>	Filter out calls originating from the selected trunks.



<b>Destination Trunk Name</b>	Filter out calls that were sent to the selected trunks.
<b>Action Type</b>	Filter calls based on the Action Type. The following actions are available: <ul style="list-style-type: none"> <li>• Dial</li> <li>• Announcements</li> <li>• Callback</li> <li>• Call Forward</li> <li>• Conference</li> <li>• DISA</li> <li>• Fax</li> <li>• Follow Me</li> <li>• IVR</li> <li>• Page</li> <li>• Parked Call</li> <li>• Queue</li> <li>• Ring Group</li> <li>• Transfer</li> <li>• VFax</li> <li>• VM</li> <li>• VMG</li> <li>• Wakeup</li> <li>• Emergency Call</li> <li>• Emergency Notify</li> <li>• SCA</li> </ul>
<b>Extension Group</b>	Filters calls made to the selected Extension Group.
<b>Account Code</b>	Filter calls with the specified Account Code. If Outbound Routes→PIN Groups→Record in CDR is enabled, Account Code information will be displayed in the CDR if applicable.
<b>Start Time</b>	Specify the earliest date and time of CDR to filter.
<b>End Time</b>	Specify the latest date and time of CDR to filter.
<b>Caller Number</b>	Enter the caller number of the CDR to filter. Patterns can be used to filter calls made from groups of similar numbers.
<b>Caller Name</b>	Enter the caller name of the CDR to filter.
<b>Callee Number</b>	Enter the callee number of the CDR to filter.

The call report will display as the following figure shows.



Status	Call from	Call to	Action Type	Start Time	Talk Time	Account Code	Recording File Options
	"John DOE" 1000	1001	DIAL	2017-05-04 04:41:49	0:00:05		-

**Figure 300: Call Report**

The CDR report has the following data fields:

- Start Time**  
 Format: 2016-09-03 00:06:16
- Call Type**  
 Example:  
 IVR  
 DIAL  
 WAKEUP
- Call From**  
 Example format:  
 "John Doe" 2000
- Call To**  
 Example format:  
 2002
- Call Time**  
 Format: 0:00:02
- Talk Time**  
 Format: 0:00:00
- Account Code**  
 Example format:  
 Grandstream/Test
- Status**  
 Answered, Busy, No answer or Failed.



Users could perform the following operations on the call report.

- **Sort by “Start Time”**

Click on the header of the column to sort the report by "Start Time". Clicking on "Start Time" again will reverse the order.


- **Download Search Results**

Click on “Download Search Result(s)” to export the filtered CDR to a .CSV file..


- **Download All Records**

Click on “Download All Records” to export all the records to a .CSV file.

- **Delete All**

Click on  **Delete All** button to remove all the call report information.




- **Delete Search Result**

On the bottom of the page, click on  **Delete Search Result (s)** button to remove the filtered CDR entries.

**Note:** When deleting CDR, a prompt will now appear asking whether to delete all recording files or not.

- **Play/Download/Delete Recording File (per entry)**

If the entry has audio recording file for the call, the three icons on the rightest column will be activated for users to select. In the following picture, the second entry has audio recording file for the call.

- Click on  to play the recording file; click on  to download the recording file in .wav format.
- Click on  to delete the recording file (the call record entry will not be deleted).



**Figure 301: Call Report Entry with Audio Recording File**

- **Automatic Download CDR Records**

Users can configure the UCM to periodically send the CDR to a configured email address. Click on “Automatic Download” and configure the parameters in the dialog below.

Automatic Download
✕

Automatically send the new CDR records to the configured Email at a certain period. If you want to upload the CDR records to an FTP/TFTP server, please go to the [Data Sync](#) page to configure.

Automatic

Download:

Delete Sent

Records:

Automatic

Download

Period:


Email:  [Email](#)  
[Template](#)

**Figure 302: Automatic Download Settings**


**Table 150: Automatic Download Settings**

<b>Automatic Download</b>	Enable the Automatic Download feature.
<b>Delete Sent Records</b>	Whether to delete the sent records or not.
<b>Automatic Download Period</b>	Configure the Automatic Download Period
<b>Email</b>	Email address blacklist/whitelist for non-local contacts. Separate multiple addresses with semicolon (;) (i.e."xxx;yyy").








### CDR Improvement

Starting from UCM6510 firmware 1.0.10.x, transferred call will no longer be displayed as a separate call entry in CDR. It will display within call record in the same entry. CDR new features can be found under Web GUI→**CDR**→**CDR**. Users can click on the  icon to expand call details and view various legs of the call.



Status	Call from	Call to	Action Type	Start Time	Talk Time	Account Code	Recording File Options
	1002	1001	DIAL	2017-05-04 04:47:58	0:00:29		-

**Figure 303: CDR Report**

Status	Call from	Call to	Action Type	Start Time	Talk Time	Account Code	Recording File Options																								
	1002	1001	DIAL	2017-05-04 04:47:58	0:00:29		-																								
<table border="1"> <thead> <tr> <th>Status</th> <th>Call from</th> <th>Call to</th> <th>Action Type</th> <th>Start Time</th> <th>Talk Time</th> <th>Account Code</th> <th>Recording File Options</th> </tr> </thead> <tbody> <tr> <td></td> <td>1002</td> <td>1001</td> <td>DIAL</td> <td>2017-05-04 04:47:58</td> <td>0:00:14</td> <td></td> <td>-</td> </tr> <tr> <td></td> <td>1002</td> <td>1002</td> <td>TRANSFER</td> <td>2017-05-04 04:48:13</td> <td>0:00:15</td> <td></td> <td>-</td> </tr> </tbody> </table>								Status	Call from	Call to	Action Type	Start Time	Talk Time	Account Code	Recording File Options		1002	1001	DIAL	2017-05-04 04:47:58	0:00:14		-		1002	1002	TRANSFER	2017-05-04 04:48:13	0:00:15		-
Status	Call from	Call to	Action Type	Start Time	Talk Time	Account Code	Recording File Options																								
	1002	1001	DIAL	2017-05-04 04:47:58	0:00:14		-																								
	1002	1002	TRANSFER	2017-05-04 04:48:13	0:00:15		-																								

**Figure 304: Detailed CDR Information**

## Downloaded CDR File

The downloaded CDR (.csv file) has different format from the Web GUI CDR. Here are some descriptions.

- **Caller number, Callee number**

"Caller number": the caller ID.

"Callee number": the Callee ID.

If the "Source Channel" contains "DAHDI", this means the call is from FXO/PSTN line.

caller number	callee number	context	calerid	source channel	dest channel	lastapp
	2009	from-internal	"Wake Up Call" <WakeUp>	Local/2009@from-internal-00000001;2	PJSIP/2009-00000013	Dial
2007	31100	from-internal	"" <2007>	PJSIP/2007-00000014	DAHDI/1-1	Dial
2009	1100	from-internal	"John Doe" <2009>	PJSIP/2009-00000015	PJSIP/trunk_1-00000016	Dial
1100	2014	from-did-direct	"1100" <1100>	DAHDI/1-1	PJSIP/2014-00000017	Dial

**Figure 305: Downloaded CDR File Sample**

- **Context**

There are different context values that might show up in the downloaded CDR file. The actual value can vary case by case. Here are some sample values and their descriptions.

**from-internal:** internal extension makes outbound calls.

**ext-did-XXXXX:** inbound calls. It starts with "ext-did", and "XXXXX" content varies case by case, which also relate to the order when the trunk is created.

**ext-local:** internal calls between local extensions.

- **Source Channel, Dest Channel**

**Sample 1:**





caller number	callee number	context	calerid	source channel	dest channel	disposition
2007	31100	from-internal	"" <2007>	PJSIP/2007-00000014	DAHDI/1-1	ANSWERED

**Figure 306: Downloaded CDR File Sample - Source Channel and Dest Channel 1**

DAHDI means it is an analog call, FXO or FXS.

For UCM6510, DAHDI/(1-2) are FXO ports, and DAHDI(3-4) are FXS ports.

### Sample 2:

caller number	callee number	context	calerid	source channel	dest channel	lastapp
2009	1100	from-internal	"Mhammed Elmrabet" <2009>	PJSIP/2009-00000015	PJSIP/trunk_1-00000016	Dial

**Figure 307: Downloaded CDR File Sample - Source Channel and Dest Channel 2**

"SIP" means it is a SIP call. There are three possible formats:

- (a) **PJSIP/NUM-XXXXXX**, where NUM is the local SIP extension number. The last XXXXX is a random string and can be ignored.
- (c) **PJSIP/trunk\_X/NUM**, where trunk\_X is the internal trunk name, and NUM is the number to dial out through the trunk.
- (c) **PJSIP/trunk\_X-XXXXXX**, where trunk\_X is the internal trunk name and it is an inbound call from this trunk. The last XXXXX is a random string and can be ignored.

There are some other possible values, but these values are almost the application name which are used by the dialplan.

**IAX2/NUM-XXXXXXX**: it means this is an IAX call.

**Local/@from-internal-XXXXX**: it is used internally to do some special feature procedure. We can simply ignore it.

**Hangup**: the call is hung up from the dial plan. This indicates there are some errors, or it has run into abnormal cases.

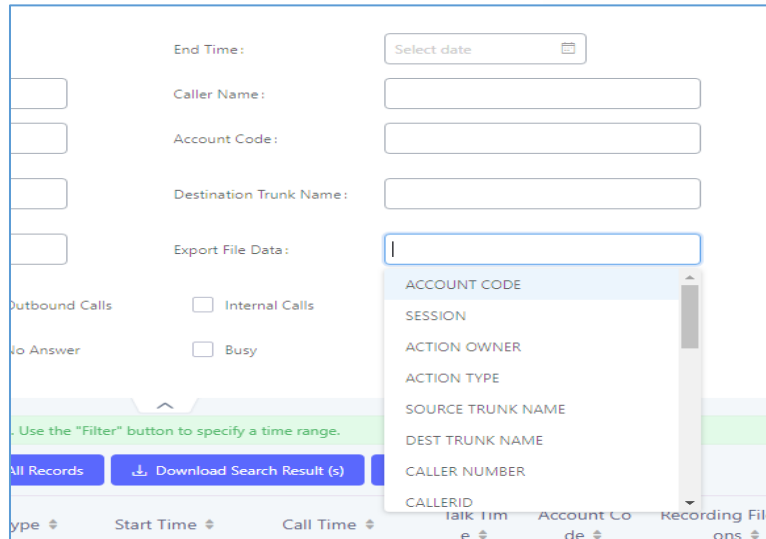
**Playback**: play some prompts to you, such as 183 response or run into an IVR.

**ReadExten**: collect numbers from user. It may occur when you input PIN codes or run into DISA.

## CDR Export Customization

Users can select the data they want to see in exported CDR reports by first clicking on the *Filter* button on the CDR page under **CDR→CDR** and selecting the desired information in the *Export File Data* field.





**Figure 308: CDR Export File data**

## Statistics

CDR Statistics is an additional feature on the UCM6510 which provides users a visual overview of calls across a period of time. Users can filter with different criteria to generate the statistics chart.



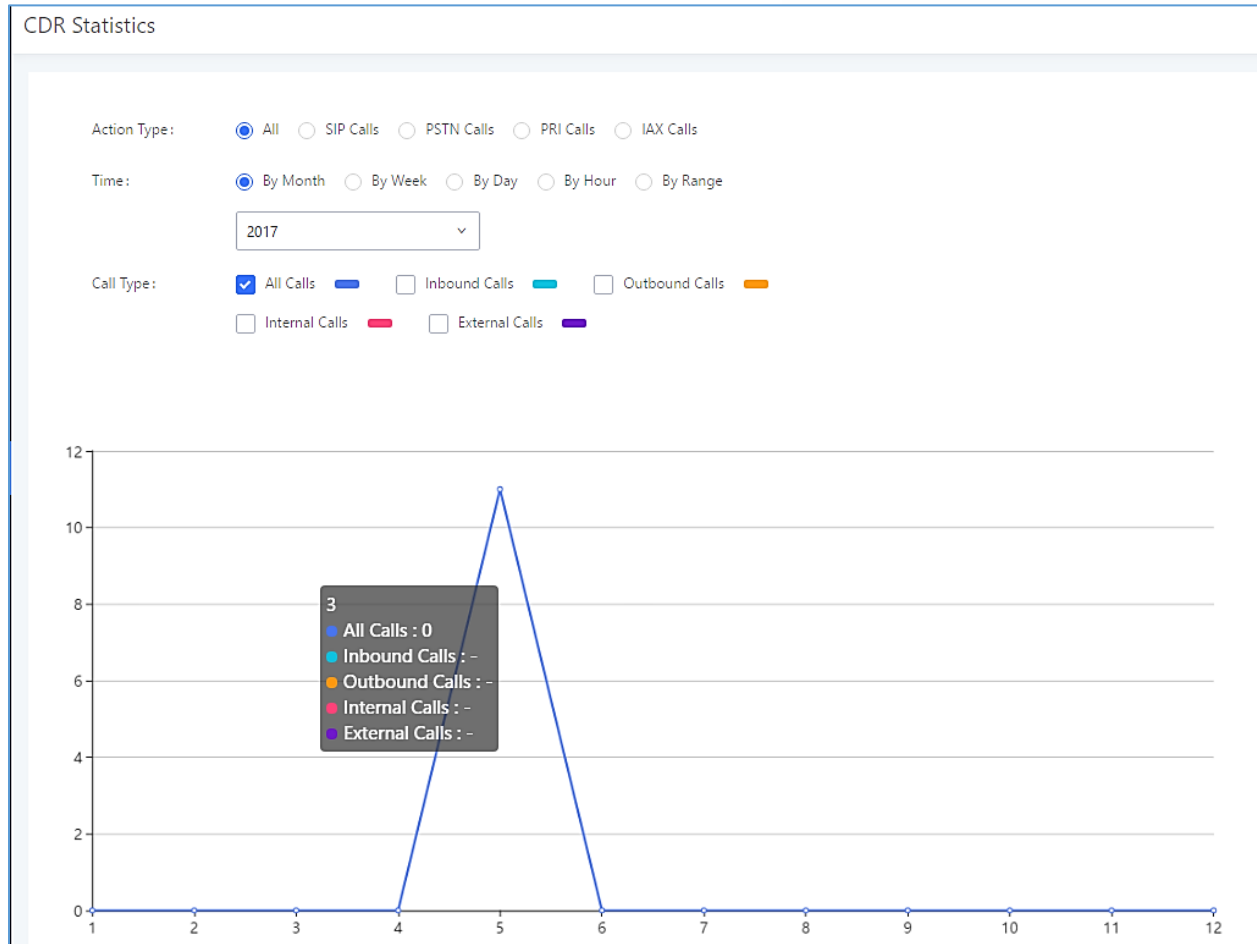


Figure 309: CDR Statistics

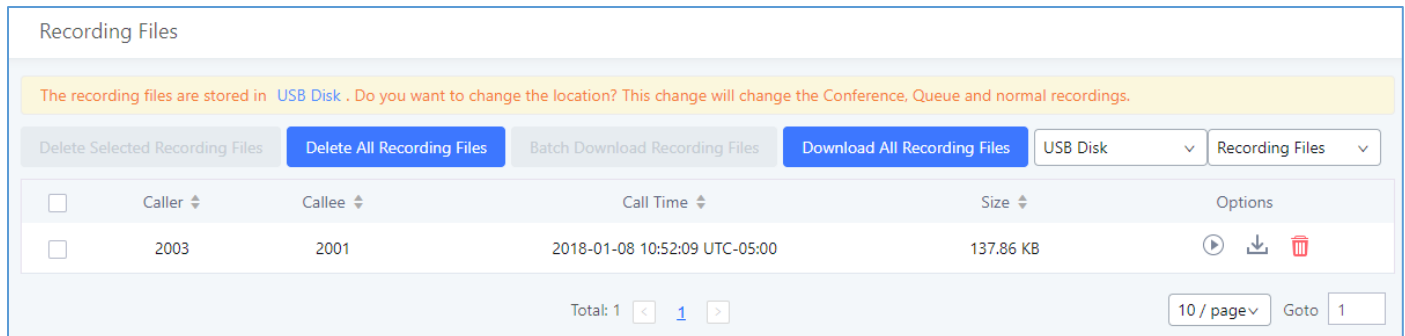
Table 151: CDR Statistics Filter Criteria

<b>Trunk Type</b>	Select one of the following trunk types. <ul style="list-style-type: none"> <li>All</li> <li>SIP Calls</li> <li>PSTN Calls</li> </ul>
<b>Call Type</b>	Select one or more in the following checkboxes. <ul style="list-style-type: none"> <li>Inbound calls</li> <li>Outbound calls</li> <li>Internal calls</li> <li>External calls</li> <li>All calls</li> </ul>
<b>Time Range</b>	<ul style="list-style-type: none"> <li>By month (of the selected year).</li> <li>By week (of the selected year).</li> <li>By day (of the specified month for the year).</li> <li>By hour (of the specified date).</li> <li>By range. For example, 2013-01 To 2013-03.</li> </ul>





## Recording Files

The Recording Files page lists all recordings saved via "Auto Record" or "Start/Stop Call Recording" feature code. If external storage (e.g., NAS, SD card, USB disk, etc.) is connected, recordings will be saved there. If no external storage is available, the recordings will be stored in UCM local storage.



**Figure 310: CDR→Recording Files**

- Click on “**Delete Selected Recording Files**” to delete the recording files.
- Click on “**Delete All Recording Files**” to delete all recording files.
- Click on “**Batch Download Recording Files**” in order to download the selected recording files.
- Click on “**Download All Recording Files**” to download all recordings files.
- Select either “**USB Disk**” or “**Local**” or “**NAS**” to show recording files stored on external or internal storage, depending on selected storage space.
- Select whether to show call recordings, queue recordings or conference recordings.
- Click on  to download the recording file in .wav format.
- Click on  to delete the recording file.
- To sort the recording file, click on the title "Caller", "Callee" or "Call Time" for the corresponding column. Click on the title again can switch the sorting mode between ascending order or descending order.

## USER PORTAL

Users could log into their web GUI portal using the extension number and user password. When an extension is created in the UCM6510, the corresponding user account for the extension is automatically created. The user portal allows access to a variety of features which include user information, extension configuration and CDR as well as settings and managing value-added features like Fax Sending, Call Queue, Wakeup Service and CRM.

Users also can access their personal data files such as call recordings, fax files, and voicemail prompts.

The login credentials are configured by Super Admin. The following figure shows the **User Management**→**Edit User** page for extension 1000. Username for an extension account cannot be modified. Please note that User Password and SIP Password are different fields and should not be mistaken for one another.

**Edit User Information: 1000**

<p>* User Name: <input type="text" value="1000"/></p> <p>Privilege: <input style="border: none; border-bottom: 1px solid #ccc; text-decoration: none; background-color: #f0f0f0; padding: 2px 5px; margin: 0 5px;" type="text" value="Consumer"/> ▾</p> <p>Fax: <input type="text"/></p> <p>First Name: <input style="background-color: #ffff00;" type="text" value="John"/></p> <p>Home Number: <input type="text"/></p>	<p>* User Password: <input type="text" value="mYpassWord!"/></p> <p>Department: <input type="text" value="Support"/></p> <p>Email Address: <input type="text" value="user1000@domain.local"/></p> <p>Last Name: <input type="text" value="DOE"/></p> <p>Mobile Phone Numb... <input type="text"/></p>
---	---

**Figure 311: Edit User Information by Super Admin**

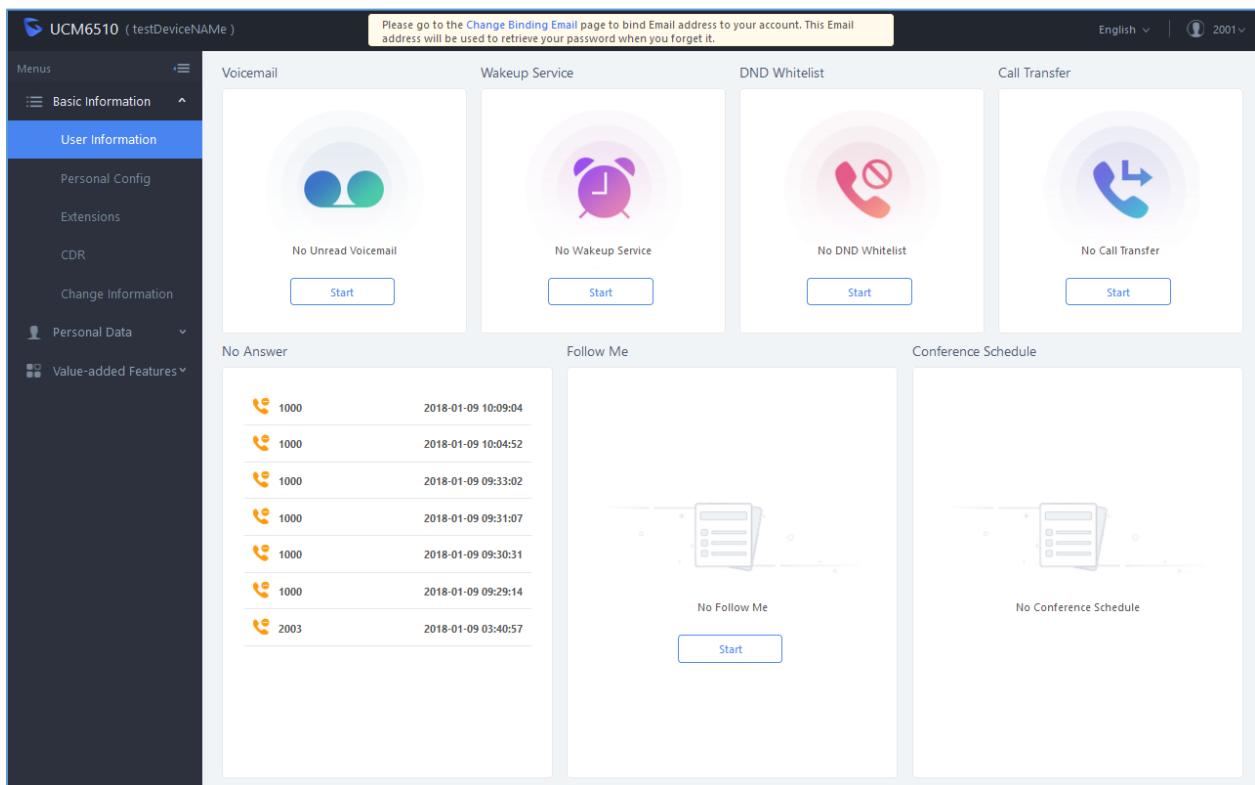
The following figure is an example of logging in with an extension account.



**Figure 312: User Portal Login**

Upon successfully logging in, the following page will appear.

**Note:** Regular users will be logged out automatically if an admin resets their extensions.



**Figure 313: User Portal Layout**

## Basic Information

Under this menu, the user can configure and change his/her personal such as first name, last name, user password, email address, and department. Users can set extension features such as presence status and call forwarding and view their CDR.

## Personal Data

In this section, users can access and manage their personal files such as voicemail, call recordings, and fax and set up Follow-Me.

## Value-added Features

On this section, the user has access to manage and use all rich value-added features which includes:

### Fax Sending

For Fax Sending configuration parameters, please refer to the **[Fax Sending]** section.

### Call Queue

If user is a member of call queue, they can check the queue's activity and for more information, please refer to **[Queue Agent]** section.

### Wakeup Service

This section allows users to create and enable Wakeup service and for more information, please refer to **[Wakeup Service from User Portal]**.

### CRM User Settings

This section allows users to enable and configure CRM connection to either SugarCRM or Salesforce.



## HIGH AVAILABILITY

The UCM6510 can interact with the HA100, a module designed to provide high availability failover functionality. This connection offers a breakthrough turnkey solution for converged voice, video, data, fax, security surveillance, and mobility applications out of the box without any extra license fees or recurring costs.

### Deployment Methods

In a setup with an HA100 device and two UCM6510, if hardware issues are detected within the primary UCM, services provided by the primary UCM will switch over to the secondary UCM, minimizing the amount of service downtime.

There are two recommended methods for creating an HA setup:

#### Method 1: Backup and restore a configuration from UCM A

1. Upgrade UCM A to at least firmware version 1.0.15.16.
2. Create a full backup of UCM A.
3. Upgrade UCM B to at least firmware version 1.0.15.16.
4. Restore the backup from UCM A to UCM B. UCM B should now have the same configuration and firmware as UCM A.
5. Follow the installation instructions from the *HA100 Quick Installation Guide* to ensure that UCM A, UCM B, and the HA device are properly connected and turned on.
6. Access UCM A's web portal, navigate to *System Settings->HA*, enable *High Available Enable*, and reboot the UCM. UCM B should also reboot during this time.
7. HA setup is now complete.

#### Method 2: Allow UCM A to synchronize its configuration with UCM B

1. Upgrade UCM A to at least firmware version 1.0.15.16.
2. Create a full backup of UCM A in case of syncing issues.
3. Upgrade UCM B to at least firmware version 1.0.15.16. While not required, it is recommended that UCM B be factory reset.
4. Follow the installation instructions from the *HA100 Quick Installation Guide* to ensure that UCM A, UCM B, and the HA device are properly connected and turned on **with the exception of the Heartbeat connection between UCM A and UCM B.**
5. Access UCM A's web portal, navigate to *System Settings->HA*, enable *High Available Enable*, and reboot the device. UCM B should also reboot during this time.
6. Connect UCM A and UCM B via their Heartbeat ports.
7. UCM A should now synchronize its configuration with UCM B

HA setup is now complete.





## HA100 Configuration

The High Availability settings are available under the Web UI→**System Settings**→**HA**. The following table describes the HA options:

**Table 152: System Settings→ HA→HA Settings**

<b>High Available Enable</b>	Enables/disables the HA functionality. By default, is Disabled.
<b>Hardware Scan</b>	Select the hardware interface to be scanned, and the system will determine whether the interface is faulty.
<b>Fault Switch</b>	When the selected hardware interfaces have fault, the backup UCM6510 take over services after master/slave handover. If not checked, UCM only report fault alarm.
<b>Heartbeat Port</b>	Specifies the heartbeat port. Default setting is: 9527 and valid range is from 0 to 65535.
<b>Heartbeat Timeout Period (s)</b>	Specifies the heartbeat timeout period. If timeout occurs, slave UCM will take over master's service. Default setting is: 7(s) and valid range is from 0 to 9.
<b>File Backup Interval(min)</b>	Specifies the file backup interval period which synchronize the relevant files to standby UCM at any given time (including records, voice mail, voice files, etc.). Default setting is 30(min) and valid range is from 30 to 720.

**Note:** Users can verify the HA status under the **Web GUI**→**System Settings**→**HA**→**HA Status** and **HA Log** pages which display the relevant information about the HA connection between the UCM6510 and the HA100, such HA Status, role of the current UCM, HA backup Status, HA backup log, HA switch log and etc.

## Upgrading HA100

As we advise to always keep maintaining and upgrading the firmware on all your Grandstream devices, users could download the latest firmware version for the HA100 from the following link:

<http://www.grandstream.com/support/firmware/>

After this, please follow below steps in order to upgrade the unit:

1. From the web GUI, navigate under the menu **System Settings**→**HA**→**HA Deconcentrator Firmware Upgrade**.
2. Ensure that the active UCM's RS485 cable is connected to the HA device.
3. Press the **Reset** button on the HA100 unit.
4. Upload the downloaded firmware file.



## Upgrading UCM6510s Connected to the HA100

The steps to upgrade both UCMs with an HA are the same as upgrading a single UCM.

1. Ensure that all connections between the HA and the two UCMs are secure and working properly.
2. Assuming that UCM A is the master and that UCM B is the slave, create a full backup of UCM A.
3. From UCM A's web portal, upgrade UCM A to the desired firmware. UCM B will also be upgrading during this time.
4. Reboot the device when prompted. UCM B will automatically reboot alongside UCM A.
5. Upon booting back up, UCM A and UCM B's LCD displays should show "Master" and "Slave" respectively.
6. Data syncing may occur for 5 or more minutes. If users cannot access the UCM web portal after booting up, please wait until the data sync is complete and try again.



# MAINTENANCE

## User Management

User management is on Web GUI → **Maintenance** → **User Management** page. User could create multiple accounts for different administrators to log in the UCM6510 Web GUI. Additionally, the system will automatically create user accounts along with creating new extensions for extension users to login to the Web GUI using their extension number and password. All existing user accounts for Web GUI login will be displayed on User Management page as shown in the following figure.

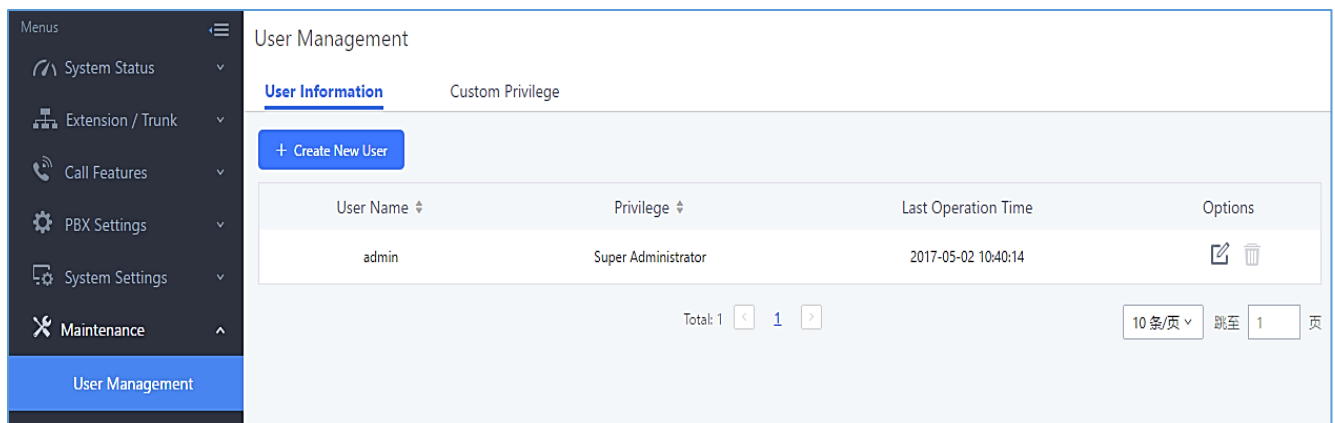
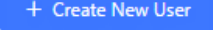


Figure 314: User Management Page Display

## User Information

When logged in as Super Admin, click on  to create a new account for Web GUI user. The following dialog will prompt. Configure the parameters as shown in below table.



### Create New User Information

* User Name: <input style="width: 90%;" type="text" value="John"/>	* User Password: <input style="width: 90%;" type="text" value="admin123"/>
Privilege: <input style="border-bottom: 1px solid #ccc;" type="text" value="Administrator"/>	Department: <input style="width: 90%;" type="text" value="IT"/>
Fax: <input style="width: 90%;" type="text"/>	Email Address: <input style="width: 90%;" type="text" value="john@domain.local"/>
First Name: <input style="width: 90%;" type="text" value="John"/>	Last Name: <input style="width: 90%;" type="text" value="DOE"/>
Home Number: <input style="width: 90%;" type="text"/>	Mobile Phone Numb... <input style="width: 90%;" type="text" value="123456789"/>

**Figure 315: Create New User**

**Table 153: User Management – Create New User**

<b>Username</b>	Configures a username to identify the user which will be required in Web GUI login. Letters, digits and underscore are allowed in the username.
<b>User Password</b>	Configures a password for this user which will be required in Web GUI login. Letters, digits, and underscore are allowed.
<b>Privilege</b>	This is the role of the Web GUI user. Currently only “Admin” is supported when Super Admin creates a new user.
<b>Department</b>	Enters the necessary information to keep a record for this user.
<b>Fax</b>	
<b>Email Address</b>	
<b>First Name</b>	
<b>Last Name</b>	
<b>Home Number</b>	
<b>Phone Number</b>	

Once created, the Super Admin can edit the users by clicking on  or delete the user by clicking on .



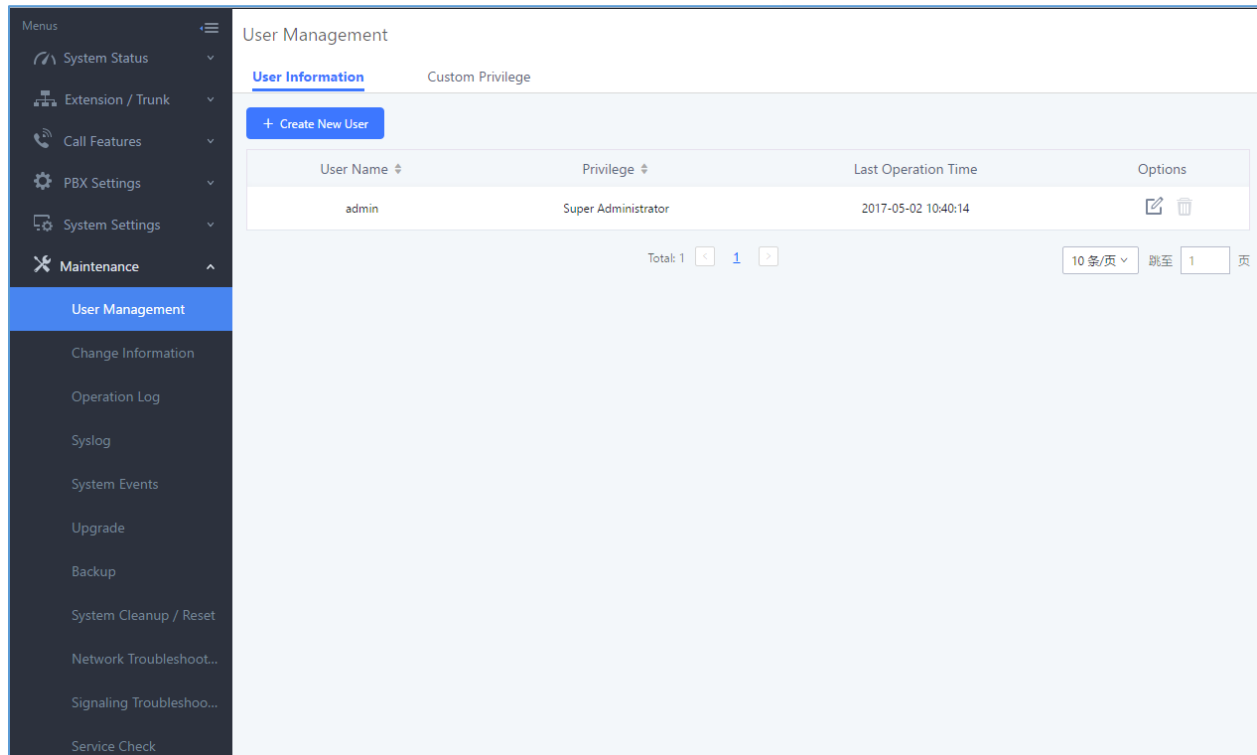


Figure 316: User Management – New Users

## Custom Privilege

Four privilege levels are supported:

- **Super Administrator**

- This is the highest privilege. Super Admin can access all pages on UCM6510 Web GUI, change configuration for all options and execute all the operations.
- Super Admin can create, edit and delete one or more users with “Admin” privilege
- Super Admin can edit and delete one or more users with “Consumer” privilege
- Super Admin can view operation logs generated by all users.
- By default, the user account “admin” is configured with “Super Admin” privilege and it is the only user with “Super Admin” privilege. The Username and Privilege level cannot be changed or deleted.
- Super Admin could change its own login password on Web GUI→**Maintenance**→**Change Information** page.
- Super Admin could view operations done by all the users in Web GUI→**Maintenance**→**Operation Log**.



- **Administrator**

- Users with “Admin” privilege can only be created by “Super Admin” user.
- “Admin” privilege users are not allowed to access the following pages:  
**Maintenance→Upgrade**  
**Maintenance→Cleaner**  
**Maintenance→Reset/Reboot**  
**Maintenance→User Management→Operation Log**
- “Admin” privilege users cannot create new users for login.

**Note:** By default, administrator accounts are not allowed to access backup menu, but this can be assigned to them by navigating to **Maintenance→User Management→Custom Privilege→Edit Admin Account** and giving the account the Backup privilege.

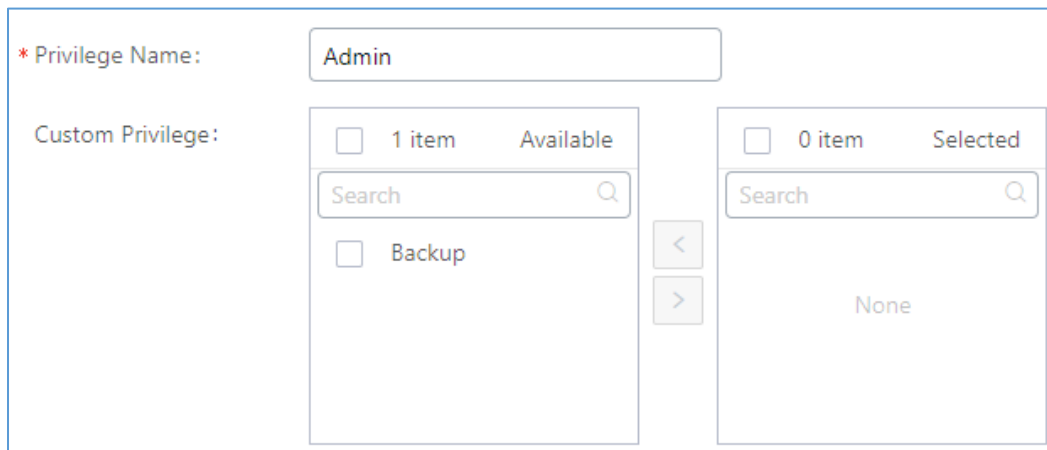

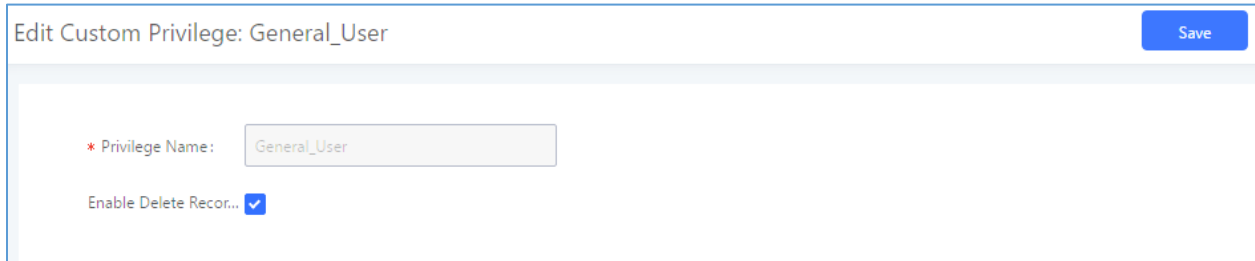


Figure 317: Assign Backup permission to “Admin” users

- **Consumer**

- A user account for Web GUI login is created automatically by the system when a new extension is created.
- The user could log in the Web GUI with the extension number and password to access user information, extension configuration, CDR of that extension, personal data and value-added features. For more details; please refer to [User Portal Guide](#).
- The SuperAdmin user can click on  the “General\_User” in order to enable/disable the custom privilege of deleting their own recording files in user level login.
- General\_User also has allowed to change Auth ID and SIP Password and Allow to Enable Voicemail options.



Edit Custom Privilege: General\_User Save

\* Privilege Name:

Enable Delete Recor...

Figure 318: General User

- **Custom Privilege**

The Super Admin user can create users with different privileges. 23 modules are available for privilege customization.

- API Configuration
- Backup
- Callback
- Call Queue
- CDR Recording Files
- CDR Records
- CDR Statistics
- Conference
- Dial By Name
- DISA
- Emergency Calls
- Event List
- Extensions
- Outbound Routes
- Inbound Routes
- Fax/T.38
- Feature Codes
- IVR
- Paging/Intercom
- Parking Lot
- Pickup Groups
- PMS - Wakeup Service
- Ring Groups
- SCA
- Speed Dial
- System Status
- System Events
- Time Settings
- Video Conference



- Voicemail
- Voice Prompt
- Wakeup Service
- Zero Config

### Create New Custom Privilege

\* Privilege Name:

Custom Privilege:

31 items Available

- API Configuration
- Callback
- Call Queue
- CDR Recording Fil...
- CDR Records

<

>

2 items Selected

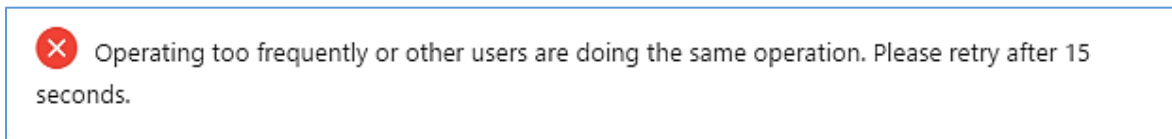
- Zero Config
- Backup

**Figure 319: Create New Custom Privilege**

System administrators can create custom privilege sets which can be assigned to created users.

### Concurrent Multi-User Login

While UCM supports simultaneous user logins, if different users are modifying the same option or doing the same operation, the following error message may appear:



**Figure 320: Multiple User Operation Error Prompt**



## Login Settings

### Change Password

After logging in the Web GUI for the first time, it is highly recommended for users to change the default password “admin” to a more complicated password for security purpose. Follow the steps below to change the Web GUI access password.

1. Go to Web GUI→**Maintenance**→**Login Settings** page.

2. Enter the old password first.

3. Enter the new password and retype the new password to confirm.

**Note:** If PBX Settings→General Settings→Enable Strong Password is toggled on, the minimum password requirements are as follows:

- Must contain at least one number.
- Must contain at least one uppercase letter, lower case letter, OR special character.

4. Configure Email Address for account recovery purpose.

5. Click on “Save”. User will be automatically logged out.

6. Once the web page comes back to the login page again, enter the username “admin” and the new password to login.

Figure 321: Change Password

Table 154: Change Password

<b>Enter Old Password</b>	Enter the Old Password for UCM6510
---------------------------	------------------------------------

<b>Enter New Password</b>	Enter the New Password for UCM6510
<b>Retype New Password</b>	Retype the New Password for UCM6510
<b>Email Address</b>	Configure an email address for account recovery purposes.

## Change Username

UCM6510 allows users now to change Super Administrator username.

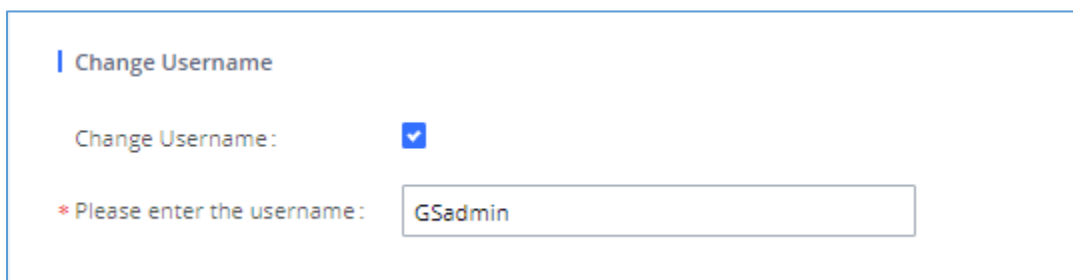


Figure 322: Change Username

Table 155: Change Username

<b>Change Username</b>	Enabling the change username option
<b>Please enter the new username</b>	Enter the new username

## Login Security

After the user logs in the UCM6510 Web GUI, the user will be automatically logged out after certain timeout, or he/she can be banned for a specific period if the login timeout is exceeded. Those values can be specified under UCM6510 web GUI → **Maintenance** → **Login Settings** → **Login Security** page.

The “**User Login Timeout**” value is in minute and the default setting is 10 minutes. If the user does not make any operation on Web GUI before the timeout, the user will be logged out automatically. After that, the Web GUI will be redirected to the login, and the user will need to enter the username and password again to log back in.

If set to 0, there will be no timeout period, and users can remain logged in for an indefinite period of time.

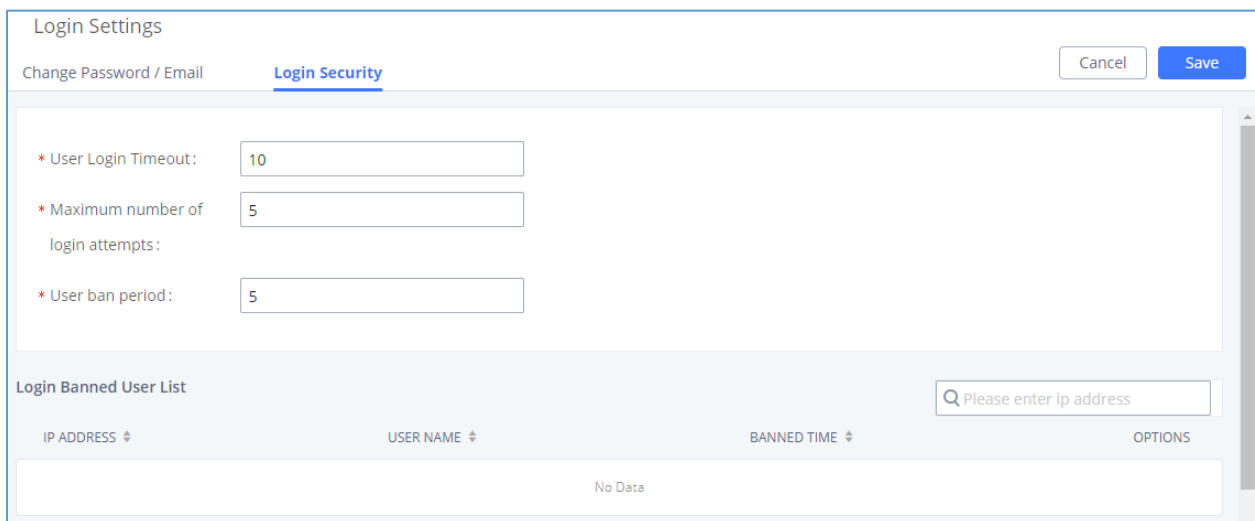


“**Maximum number of login attempts**” protects the UCM against brute force authentication attempts. If the number of attempts from an IP address exceeds the configured value, it will be blacklisted, and the IP address will be banned based on the configured User ban period. Default value is 5.

“**User ban period**” specifies the amount of time (in minutes) that an IP address is banned from attempting to log into the UCM system. A value of 0 indicates a permanent ban. Default value is 5.

“**Login Banned User List**” shows the list of IP addresses banned from the UCM.

“**Login Whitelist**” Users can create a list of IP addresses that will not be banned even if they exceed the maximum number of failed login attempts.



The screenshot shows the 'Login Settings' interface. At the top, there are tabs for 'Change Password / Email' and 'Login Security' (which is selected). There are 'Cancel' and 'Save' buttons in the top right. Below the tabs, there are three input fields for security settings:

- \* User Login Timeout: 10
- \* Maximum number of login attempts: 5
- \* User ban period: 5

Below these settings is a section titled 'Login Banned User List'. It features a search bar with the placeholder text 'Please enter ip address'. Below the search bar is a table with the following columns: IP ADDRESS, USER NAME, BANNED TIME, and OPTIONS. The table currently contains the text 'No Data'.

**Figure 323: Login Timeout Settings**

## Operation Log

The Operation Log lists all activities done by all users that have accessed the UCM web portal. This page is found under **Maintenance**→**Operation Log**.

Operation Log <span style="float: right;">Filter</span>						
Delete Search Result (5)		Delete All Logs				
Date	User Name	IP Address	Results	Page Operation	Specific Operation	Remark
2017-08-03 05:40:50	admin	192.168.6.223	Operation successful	Apply Changes		Click to modify notes.
2017-08-03 05:40:49	admin	192.168.6.223	Operation successful	Extensions: Create New SIP Extension	Extension: 1000,1001,1002,1003,1004. ⓘ	Click to modify notes.
2017-08-03 05:40:49	admin	192.168.6.223	Operation successful	Follow Me: Create New Follow Me	ⓘ	Click to modify notes.
2017-08-03 05:33:07	admin	192.168.6.223	Operation successful	Login: Login	User Name: admin. ⓘ	Click to modify notes.
2017-08-03 05:17:58	admin	192.168.6.223	Operation successful	Login: Login	User Name: admin. ⓘ	Click to modify notes.
2017-08-03 04:48:18	admin	192.168.6.223	Operation successful	Login: Login	User Name: admin. ⓘ	Click to modify notes.
2017-08-03 04:19:47	admin	192.168.6.223	Operation successful	Login: Login	User Name: admin. ⓘ	Click to modify notes.
2017-08-03 03:51:20	admin	192.168.6.223	Operation successful	Login: Login	User Name: admin. ⓘ	Click to modify notes.

Total: 8    10 / page    Goto 1

**Figure 324: Operation Logs**

The operation log can be sorted and filtered for easy access. Click on the header of each column to sort based on those columns. For example, clicking on “Date” will sort the logs according to operation date and time. Clicking on “Date” again will reverse the order.

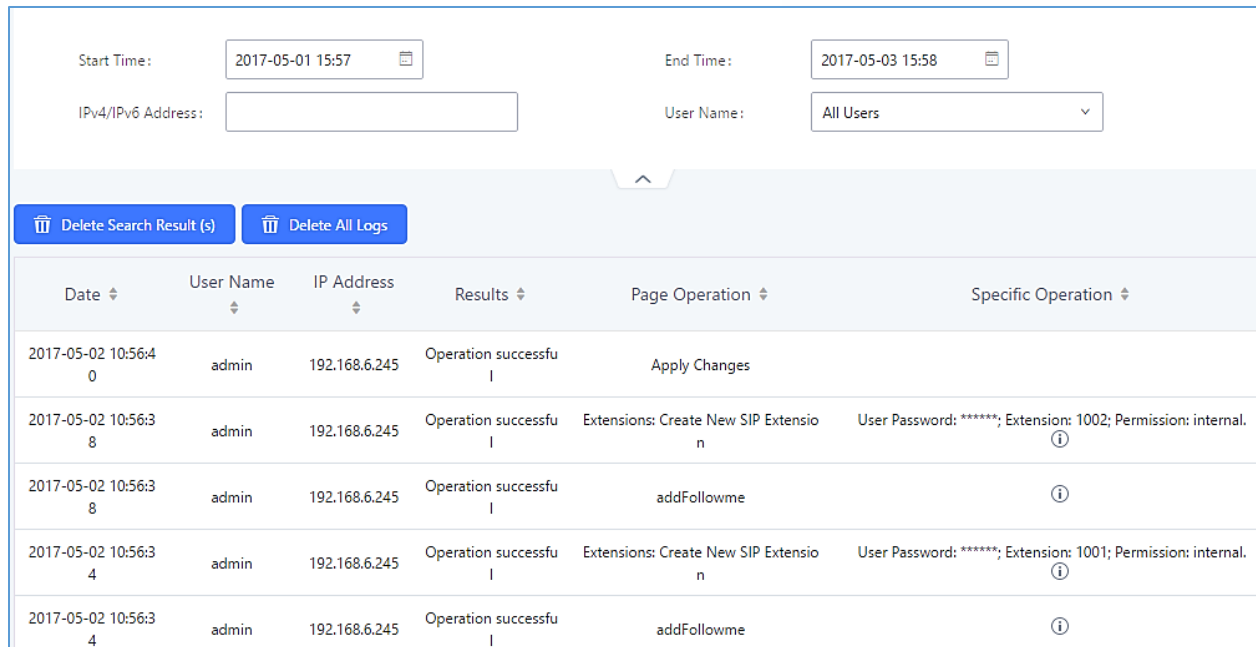
**Table 156: Operation Log Column Header**

<b>Date</b>	The date and time when the operation is executed.
<b>Username</b>	The username of the user who performed the operation.
<b>IP Address</b>	The IP address from which the operation is made.
<b>Results</b>	The result of the operation.
<b>Page Operation</b>	The page where the operation is made. For example, login, logout, delete user, create trunk and etc.
<b>Specific Operation</b>	Click on ⓘ to view the options and values configured by this operation.
<b>Remark</b>	Allows users to add notes and remarks to each operation

User could also filter the operation logs by time condition, IP address and/or username. Configure these




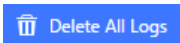
conditions and then click on .



Date	User Name	IP Address	Results	Page Operation	Specific Operation
2017-05-02 10:56:40	admin	192.168.6.245	Operation successful	Apply Changes	
2017-05-02 10:56:38	admin	192.168.6.245	Operation successful	Extensions: Create New SIP Extension	User Password: *****; Extension: 1002; Permission: internal.
2017-05-02 10:56:38	admin	192.168.6.245	Operation successful	addFollowme	
2017-05-02 10:56:34	admin	192.168.6.245	Operation successful	Extensions: Create New SIP Extension	User Password: *****; Extension: 1001; Permission: internal.
2017-05-02 10:56:34	admin	192.168.6.245	Operation successful	addFollowme	

**Figure 325: Operation Logs Filter**

In the figure above, operations made by user “support” on device with IP 192.168.40.173 from 2014-11-01 00:00 to 2014-11-06 15:38 are filtered out and displayed.

To delete operation logs, users can either filter out specific operation logs then click on the  button to delete the filtered results or click on the  button to delete all operation logs.

**Note:** Deleting operation logs will generate an operation log entry detailing the action.

## Upgrading

The UCM6510 can be upgraded to a new firmware version remotely or locally. This section describes how to upgrade your UCM6510 via network or local upload.

### Upgrading via Network

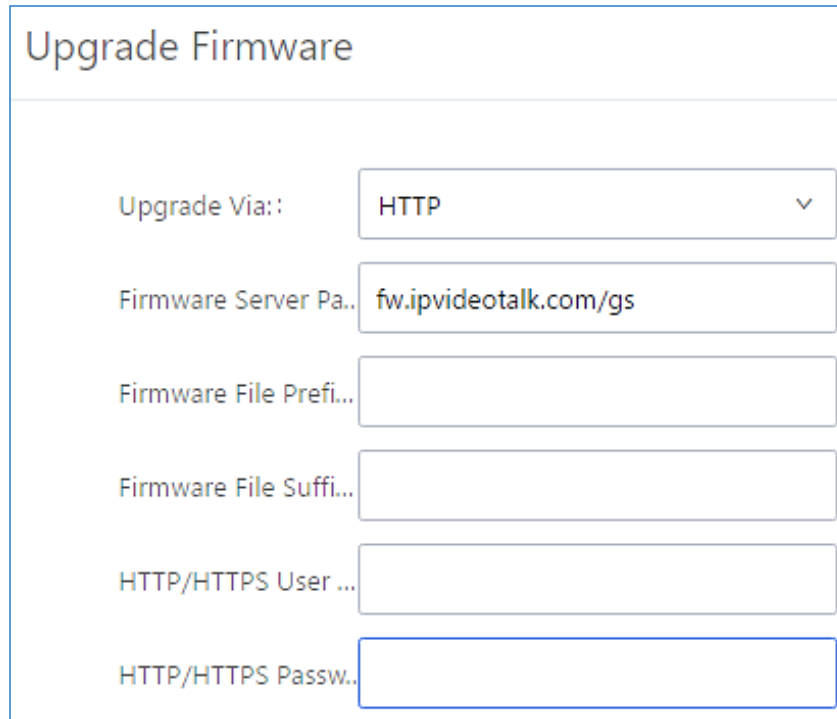
The UCM6510 can be upgraded via TFTP/HTTP/HTTPS by configuring the URL/IP Address for the TFTP/HTTP/HTTPS server and selecting a download method. Configure a valid URL for TFTP, HTTP or HTTPS; the server name can be FQDN or IP address.



**Examples of valid URLs:**

firmware.grandstream.com/BETA

The upgrading configuration can be accessed via Web GUI→**Maintenance**→**Upgrade**.



**Figure 326: Network Upgrade**

**Table 157: Network Upgrade Configuration**

<b>Upgrade Via</b>	Allow users to choose the firmware upgrade method: TFTP, HTTP or HTTPS.
<b>Firmware Server Path</b>	Define the server path for the firmware server.
<b>Firmware File Prefix</b>	If configured, only the firmware with the matching encrypted prefix will be downloaded and flashed into the UCM6510.
<b>Firmware File Suffix</b>	If configured, only the firmware with the matching encrypted postfix will be downloaded and flashed into the UCM6510.
<b>HTTP/HTTPS Username</b>	The username for the HTTP/HTTPS server.
<b>HTTP/HTTPS Password</b>	The password for the HTTP/HTTPS server.

Please follow the steps below to upgrade the firmware remotely.

1. Enter the firmware server path under Web GUI→**Maintenance**→**Upgrade**.

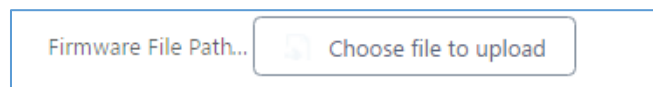


2. Click on "Save". Then reboot the device to start the upgrading process.
3. Please be patient during the upgrading process. Once done, a reboot message will be displayed in the LCD.
4. Manually reboot the UCM6510 when it is appropriate to avoid immediate service interruption. After it boots up, log in the Web GUI to check the firmware version.

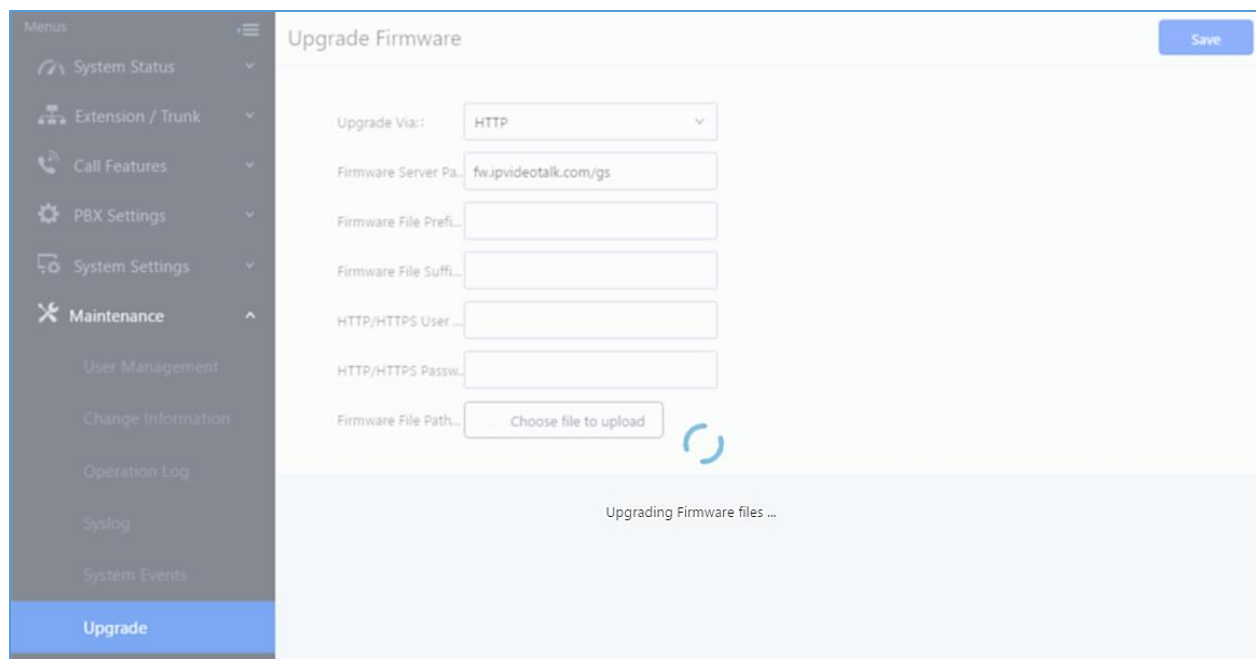
## Upgrading via Local Upload

If there is no HTTP/TFTP server, users could also upload the firmware to the UCM6510 directly via Web GUI. Please follow the steps below to upload firmware locally.

1. Download the latest UCM6510 firmware file from the following link and save it in your PC.
2. <http://www.grandstream.com/support/firmware>
3. Log in the Web GUI as administrator in the PC.
4. Go to Web GUI→**Maintenance**→**Upgrade**, upload the firmware file by clicking on “Choose file to upload” and select the firmware file from your PC. The default firmware file name is ucm6510fw.bin



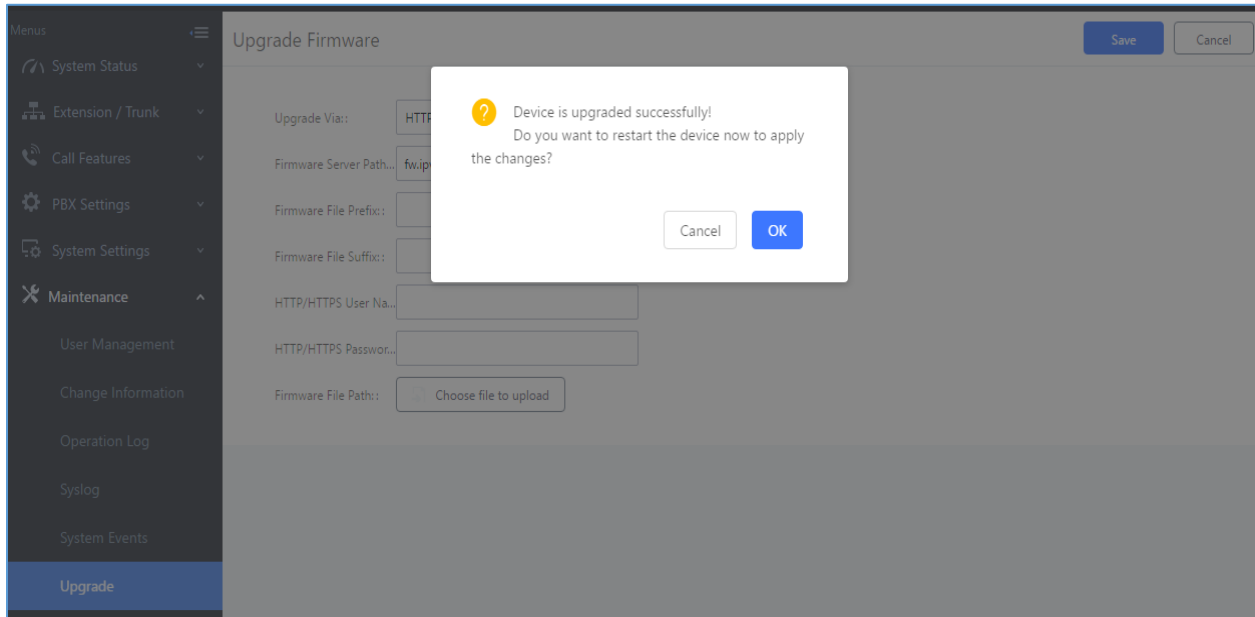
**Figure 327: Local Upgrade**



**Figure 328: Upgrading Firmware Files**

1. Wait until the upgrading process is successful and a window will be popped up in the Web GUI.





**Figure 329: Reboot UCM6510**

2. Click on "OK" to reboot the UCM6510 and check the firmware version after it boots up.

---

**⚠ Notes:**

- Please do not interrupt or power cycle the UCM6510 during upgrading process.
  - The firmware file name allows the use of the special characters besides the following restricted characters: # \$ ^ & \* + ( ) [ ] / ; ' | , < > ?
- 

### No Local Firmware Servers

Service providers should maintain their own firmware upgrade servers. For users who do not have TFTP/HTTP/HTTPS server. Some free windows version TFTP servers are available for download from [http://www.solarwinds.com/products/freetools/free\\_tftp\\_server.aspx](http://www.solarwinds.com/products/freetools/free_tftp_server.aspx)  
<http://tftpd32.jounin.net>

Please check our website at <http://www.grandstream.com/support/firmware> for latest firmware.

Instructions for local firmware upgrade via TFTP:

1. Unzip the firmware files and put all of them in the root directory of the TFTP server;





2. Connect the PC running the TFTP server and the UCM6510 to the same LAN segment;
3. Launch the TFTP server and go to the File menu→Configure→Security to change the TFTP server's default setting from "Receive Only" to "Transmit Only" for the firmware upgrade;
4. Start the TFTP server and configure the TFTP server in the UCM6510 web configuration interface;
5. Configure the Firmware Server Path to the IP address of the PC;
6. Update the changes and reboot the UCM6510.

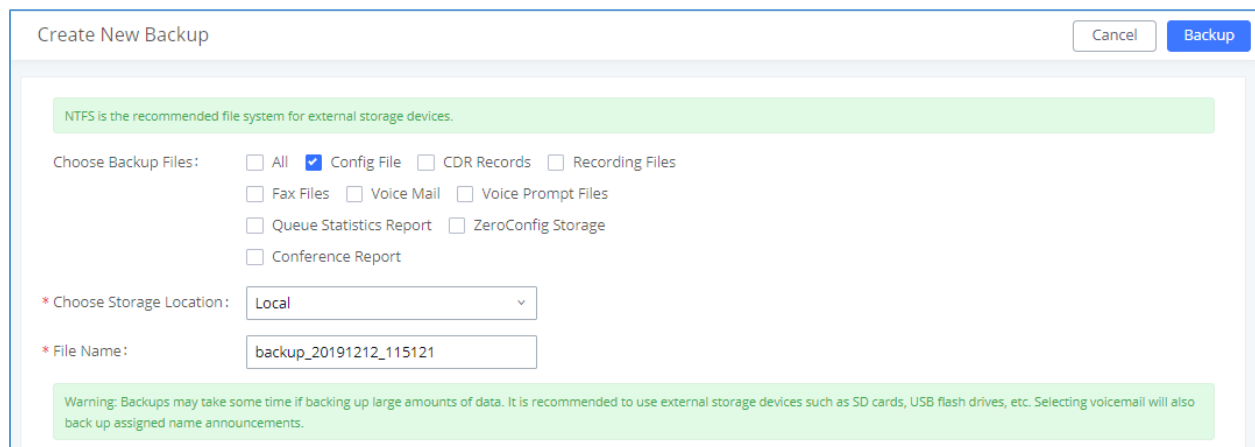
End users can also choose to download a free HTTP server from <http://httpd.apache.org/> or use Microsoft IIS web server.

## Backup

The UCM6510 configuration can be backed up locally or via network. The backup file will be used to restore the configuration on UCM6510 when necessary.

### Backup/Restore




To create backups, navigate to **Maintenance→Backup→Backup/Restore** and click on the Backup button to start the process.



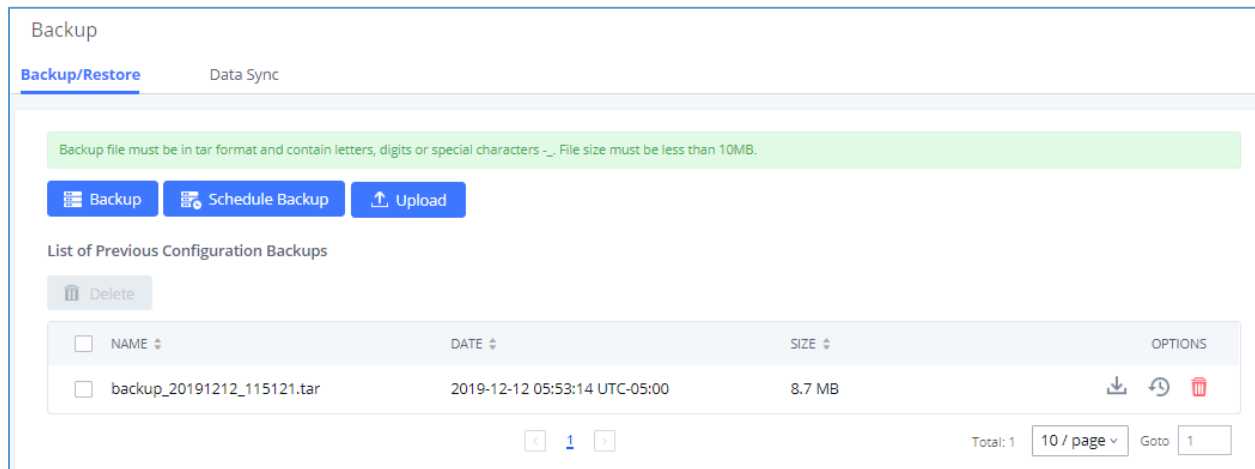
**Figure 330: Create New Backup**

1. Choose the files to be included in the backup.
2. Choose where to store the backup file: USB Disk, SD Card, Local or NAS.  
**Note:** USB Disk or SD card options will show only if plugged; NAS server will show only if configured and status is available. Refer to [PBX Settings/NAS].
3. Name the backup file.
4. Click on "Backup" to start backup.

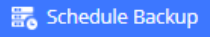


Once the backup is done, it will appear in the List of Previous Configuration Backups. From this list, users can download, restore, and delete backups. Users can download , restore , or delete  it from the UCM6510 internal storage or the external device.

Users can also upload UCM backups from their PC to the UCM by clicking on the Upload button. Note: Uploaded backup files can only be 10MB or lower in file size.



**Figure 331: Backup / Restore**

The  option allows UCM to perform periodic backups to USB disks, SD cards, SFTP servers, or NAS servers. Users can configure the hour and frequency of the periodic backup.

Users can test connections with SFTP servers.

### Schedule Backup

NTFS is the recommended file system for external storage devices.

Enable Scheduled Backup:

Choose Backup Files:

All
  Config File
  CDR Records
  Recording Files

Fax Files
  Voice Mail
  Voice Prompt Files

Queue Statistics Report
  ZeroConfig Storage

Conference Report

Choose Storage Location: SFTP Server

\* Account:

Password:

\* Server Address:

Destination Directory:

\* Backup Time: 00:00

\* Backup Frequency: 1

+ Test Connection

Warning: If the "Voice Mail" option is selected, the assigned name announcements will also be backed up.

**Figure 332: Local Backup**

## Data Sync

Besides local backup, users can back up call recordings, voicemail, CDR, and fax daily to an SFTP server via the Data Sync feature in the **Maintenance**→**Backup**→**Data Sync** page.

Special characters such as @ and periods (.) are supported, allowing users to use email addresses as SFTP account usernames and to specify destination directories on the SFTP server. If a specified directory does not exist on the SFTP server, the UCM will create it automatically.



### Backup

Backup/Restore
Data Sync

Use SFTP to automatically sync CDR, recordings, voicemail, CDR, and fax every day.

#### Data Sync Configuration

Enable Data Sync:

Choose Data Sync Files:  CDR Records  Recording Files  
 Voice Mail  Fax

\* Account:

Password:

\* Server Address:

Destination Directory:

\* Sync Time:

+ Test Connection
+ Synchronize All Data

#### Data Sync Log

Clean

No record to view

**Figure 333: Data Sync**

**Table 158: Data Sync Configuration**

<b>Enable Data Sync</b>	Enable the auto backup function. The default setting is "No".
<b>Account</b>	Enter the Account name on the SFTP backup server.
<b>Password</b>	Enter the Password associate with the Account on the SFTP backup server.
<b>Server Address</b>	Enter the SFTP server address.
<b>Destination Directory</b>	Specify the directory in SFTP server to keep the backup file. Format: 'xxx/xxx/xxx', If this directory does not exist, UCM will create this directory automatically.
<b>Sync Time</b>	Enter 0-23 to specify the backup hour of the day.



Before saving the configuration, users can click on the Test Connection button to verify connection status. Clicking on the Synchronize All Data button will manually start a data sync.

Save the changes and all the backup logs will be listed on the web page.



## Restore Configuration from Backup File

To restore the configuration on the UCM6510 from a backup file, users could go to Web GUI→**Maintenance**→**Backup**→**Backup/Restore**.

- A list of previous configuration backups is displayed on the web page. Users could click on  of the desired backup file to override the UCM current settings with the backup's.
- If users have other backup files on PC to restore on the UCM6510, click on "Upload Backup File" first and select it from local PC to upload on the UCM6510. Once the uploading is done, this backup file will be displayed in the list of previous configuration backups for restore purpose. Click on  to restore from the backup file.
- Users can restore backup files located on SD cards, USB disks, or NAS servers.





List of Previous Configuration Backups				
 Delete Selected Backup File (s)				
<input type="checkbox"/>	Name ↕	Date ↕	Size ↕	Options
<input type="checkbox"/>	backup_2017504_083408.tar	2017-05-04 03:36:21 UTC-04:00	4.1 MB	  

Figure 334: Restore UCM6510 from Backup File

---

### Note:

- The uploaded backup file must be a tar file with no special characters like \*,!,#,@,&,\$,%^,(,),/, \,space in the file name.
  - Uploaded backup file size cannot exceed 10MB.
- 

## System Cleanup/Reset

### Reset and Reboot

Users could perform reset and reboot under Web GUI→**Maintenance**→**Reset and Reboot**.

To factory reset the device, select the Type. There are two different reset types.



- **User Data**  
Voicemail, call recordings, voice prompts, Music on Hold files, CDR, and backup files will be erased.
- **All**  
All files will be erased, and all settings will be reset to factory settings.

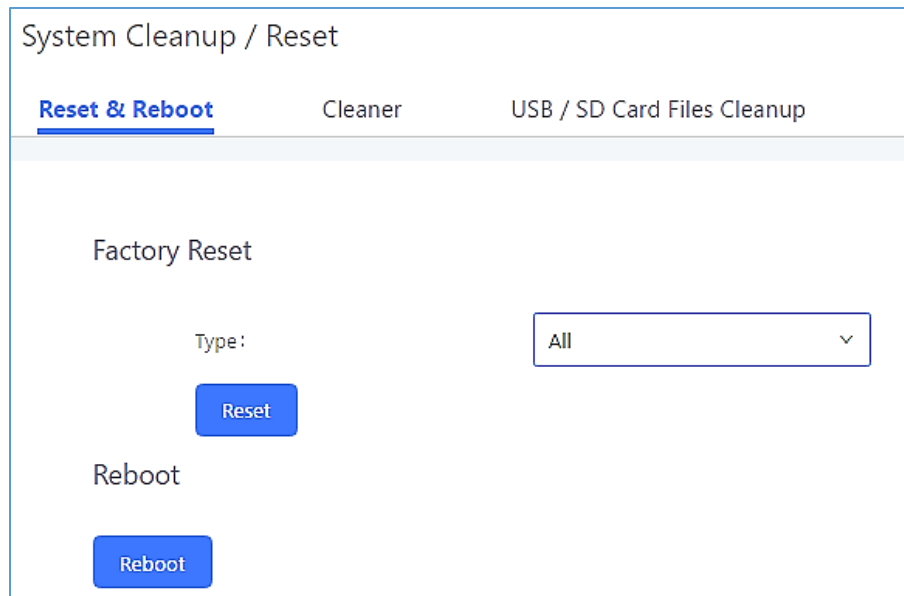


Figure 335: Reset and Reboot

## Cleaner

The UCM can be configured to delete files, CDR, voicemail, and calls statistic reports on a regular basis. This feature can be accessed from the **Maintenance**→**System Cleanup/Reset**→**Cleaner** page.

System Cleanup / Reset
Reset & Reboot   **Cleaner**   USB Disk/SD Card File Management
Cancel   Save

Clean CDR, recordings, voicemail, and fax automatically.

**CDR Cleaner**

Enable Cleaner:

Clean Time:

Cleaning Conditions:

Clean Interval:

**Queue Statistics Report Cleaner**

Enable Cleaner:

Clean Time:

Cleaning Conditions:

Clean Interval:

**Conference Call Statistics Report Cleaner**

Enable Cleaner:

Clean Time:

Cleaning Conditions:

Clean Interval:

**File Cleaner**

Enable Cleaner:

Clean Files in External Storage:

Choose Cleaner Files:

<input type="checkbox"/> Basic Call Recording Files	<input type="checkbox"/> Conference Recording Files
<input type="checkbox"/> Call Queue Recording Files	<input type="checkbox"/> Voicemail Files
<input type="checkbox"/> Fax	<input type="checkbox"/> Emergency Calls Recording Files
<input type="checkbox"/> SCA Recording Files	<input type="checkbox"/> Backup Files

Clean Time:

Cleaning Conditions:

File Clean Threshold:

Keep Last X Days:

**Cleaner Log**

No record to view

**Figure 336: Cleaner**



**Table 159: Cleaner Configuration**

<b>CDR Cleaner</b>	
<b>Enable Cleaner</b>	Enable the CDR Cleaner function.
<b>Clean Time</b>	Enter 0-23 to specify the hour of the day to clean up CDR.
<b>Cleaning Conditions</b>	<ul style="list-style-type: none"> <li>• <b>By Schedule:</b> If the clean interval is 3, cleaning will be performed every 3 days to remove all records that were generated in the past 3 days.</li> <li>• <b>Keep Last X Records:</b> If the max number of CDR has been reached, CDR will be deleted starting with the oldest entry at the configured cleaning time. (Note: The amount of records displayed on the page of call queue statistics is not one-to-one with the actual amount of records in the database.)</li> <li>• <b>Keep Last X Days:</b> Delete all entries older than X days.</li> </ul>
<b>Clean Interval</b>	Enter 1-30 to specify the day of the month to clean up CDR when <b>By Schedule</b> is selected as <b>Cleaning Conditions</b> .
<b>Max Entries</b>	Set the maximum number of CDR entries to keep when <b>Keep Last X Records</b> is selected as <b>Cleaning Conditions</b> . Default is 50000. Valid range: 10000 – 100000.
<b>Keep Last X Days</b>	Enter the number of days of call log entries to keep when <b>Keep Last X days</b> is selected as <b>Cleaning Conditions</b> . Default is 30. Valid range: 1 – 100.
<b>Queue Statistics Report Cleaner</b>	
<b>Enable Cleaner</b>	Enable scheduled queue log cleaning.
<b>Clean Time</b>	Enter the hour of the day to start the cleaning. The valid range is 0-23.
<b>Cleaning Conditions</b>	<ul style="list-style-type: none"> <li>• <b>By Schedule:</b> If the clean interval is 3, cleaning will be performed every 3 days to remove all records that were generated 3 days ago.</li> <li>• <b>Keep Last X Records:</b> If the max number of Queue Statistics Report entries has been reached, Queue Statistics Report entries will be deleted starting with the oldest entry at the configured cleaning time. (Note: The amount of records displayed on the page of call queue statistics is not one-to-one with the actual amount of records in the database.)</li> <li>• <b>Keep Last X Days:</b> Delete all entries older than X days.</li> </ul>





<b>Clean Interval</b>	Enter how often (in days) to clean queue logs when <b>By Schedule</b> is selected as <b>Cleaning Conditions</b> . The valid range is 1-30.
<b>Max Entries</b>	Set the maximum number of Queue Statistics Report entries to keep when <b>Keep Last X Records</b> is selected as <b>Cleaning Conditions</b> . Default is 50000. Valid range: 10000 – 100000.
<b>Keep Last X Days</b>	Enter the number of days of Queue Statistics Report entries to keep when <b>Keep Last X days</b> is selected as <b>Cleaning Conditions</b> . Default is 30. Valid range: 1 – 100.
<b>Conference Call Statistics Report Cleaner</b>	
<b>Enable Cleaner</b>	Enable scheduled conference log cleaning.
<b>Clean time</b>	Enter the hour of the day to start the cleaning. The valid range is 0-23.
<b>Cleaning Conditions</b>	<ul style="list-style-type: none"> <li>• <b>By Schedule:</b> If the clean interval is 3, cleaning will be performed every 3 days to remove all records that were generated 3 days ago.</li> <li>• <b>Keep Last X Records:</b> If the max number of Conference Call Statistics Report has been reached, Conference Call Statistics Report will be deleted starting with the oldest entry at the configured cleaning time. (Note: The amount of records displayed on the page of call queue statistics is not one-to-one with the actual amount of records in the database.)</li> <li>• <b>Keep Last X Days:</b> Delete all entries older than X days.</li> </ul>
<b>Clean Interval</b>	Enter how often (in days) to clean queue logs when <b>By Schedule</b> is selected as <b>Cleaning Conditions</b> . The valid range is 1-30.
<b>Max Entries</b>	Set the maximum number of CDR Conference Call Statistics Report entries to keep when <b>Keep Last X Records</b> is selected as <b>Cleaning Conditions</b> . Default is 50000. Valid range: 10000 – 100000.
<b>Keep Last X Days</b>	Enter the number of days of Conference Call Statistics Report entries to keep when <b>Keep Last X days</b> is selected as <b>Cleaning Conditions</b> . Default is 30. Valid range: 1 – 100.
<b>File Cleaner</b>	
<b>Enable Cleaner</b>	Enabling files cleaning.
<b>Clean Files in External Device</b>	If enabled the files in external device (USB/SD card) will be automatically cleaned up as configured.



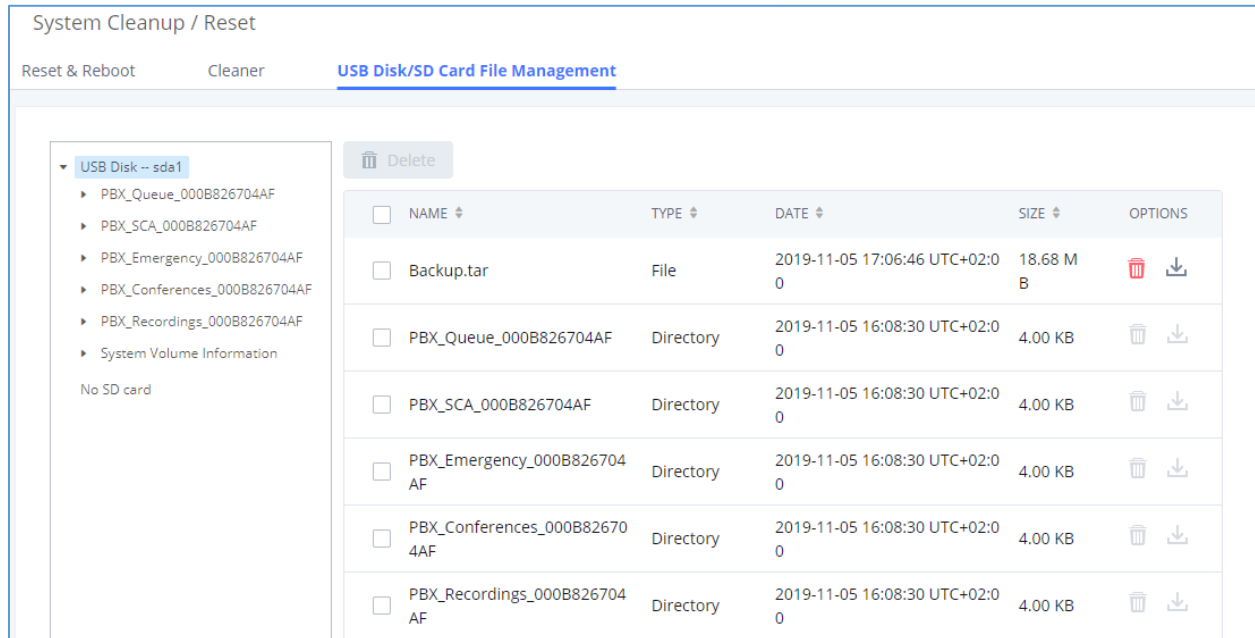
<b>Choose Cleaner File</b>	Select the files for system automatic clean. <ul style="list-style-type: none"> <li>• Basic Call Recording Files.</li> <li>• Conference Recording Files.</li> <li>• Call Queue Recording Files.</li> <li>• Voicemail Files.</li> <li>• Emergency Calls Recording Files.</li> <li>• Fax.</li> <li>• Backup Files.</li> <li>• SCA Recording Files.</li> </ul>
<b>Clean Time</b>	Enter the hour of the day to start the cleaning. The valid range is 0-23.
<b>Cleaning Conditions</b>	<ul style="list-style-type: none"> <li>• <b>By Schedule:</b> If the clean interval is 3, cleaning will be performed every 3 days to delete all files.</li> <li>• <b>By Threshold:</b> Check at the configured cleaning time every day to see if the storage threshold has been exceeded and perform cleaning of all files if it has.</li> <li>• <b>Keep Last X Days:</b> Delete all files older than X days.</li> </ul>
<b>File Clean Interval</b>	Enter 1-30 to specify the day of the month to clean up the files.
<b>File Clean Threshold</b>	Enter the internal storage disk usage threshold (in percent). Once this threshold is exceeded, the file cleanup will proceed as scheduled. Valid range is 0-99.
<b>Keep Last X Days</b>	Automatically delete all recordings older than this x days when the threshold is reached. If not set, all data is cleared. Valid range: 1 – 100.
<b>Cleaner Log</b>	
<b>Cleaner Log</b>	Clicking on the Clean button will clear the cleaner log.

All the cleaner logs will be listed on the bottom of the page.

## USB Disk/SD Card File Management

From this page, users can view, download, and delete files on USB disks and SD cards.





**Figure 337: USB/SD Card Files Cleanup**

**Table 160: USB/SD Card Files Cleanup**

<b>Current Path</b>	Displays the current path.
<b>Directory</b>	Select the directory user want to clean.
<b>Delete Selected File</b>	Select multiple entries to delete from USB or SD card.

## System Recovery

In the scenario where the UCM cannot be accessed via web or SSH, users can try to recover the system by resetting the system or upgrading system firmware via the UCM's recovery mode.

To access recovery mode, follow these steps:

1. Disconnect the power cable from the UCM and keep the network cable connected.
2. Press and hold the reset button located on the back of the UCM.
3. Reconnect the power cable while holding the reset button.
4. Keep holding until a click sound is heard. Release the reset button.
5. The UCM's LCD should now display "Recovery Mode" and an IP address.

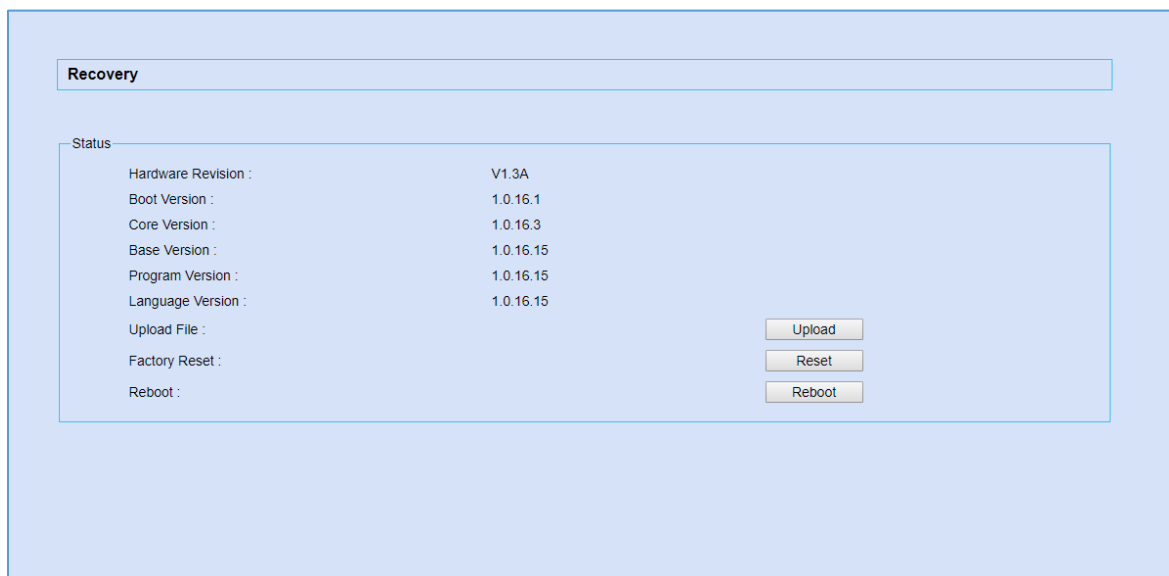
Once at this stage, the administrator can access the recovery mode web portal by typing in either the IP0 address (typically WAN) or IP1 address (typically LAN) into a browser address bar. The following page should appear:





**Figure 338: UCM6xxx Recovery Web Page**

Enter the super admin's login credentials and click on the Login button:

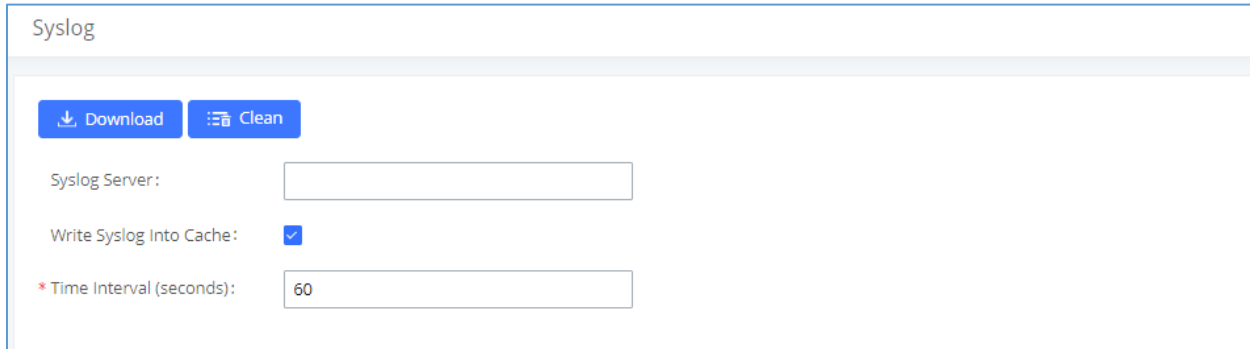


**Figure 339: Recovery Mode**

From here, the user can either upload a firmware file, factory reset or just reboot the device.

## Syslog

On the **Maintenance**→**Syslog** page, users can configure the UCM to send syslog to a remote server. By default, ERROR logs are enabled for all PBX modules. Additional syslog levels are WARN, NOTICE, DEBUG, and VERBOSE.



**Figure 340: Syslog Server**

**Table 161: Syslog Parameters**

<b>Syslog Server</b>	The URL/IP address for the syslog server.
<b>Write Syslog into Cache</b>	If enabled, syslog will be sent to and cached in system memory until it is written to internal storage at the specified time interval. Enabling this helps to improve the lifespan of the UCM's flash storage.
<b>Time Interval (seconds)</b>	Configures the period of time that must pass before writing the cached syslog to internal storage. Setting the time interval too high may result in lost syslog data due to the low saving frequency.

- **pbx:** This module is related to general PBX functions.
- **chan\_sip:** This module is related to SIP calls.
- **chan\_dahdi:** This module is related to analog calls (FXO/FXS).
- **app\_meetme:** This module is related to Conference room.

---

 **Note:**

Syslog are for debugging and troubleshooting. It is not recommended to enable syslog for all modules and levels, as it can cause excessive resource usage and network load.

UCM reserves a 50MB cache for syslog. Once the syslog has reached 50MB in file size, 2MB of syslog will be deleted, starting from the oldest syslog. This ensures that the system can continue logging.

---

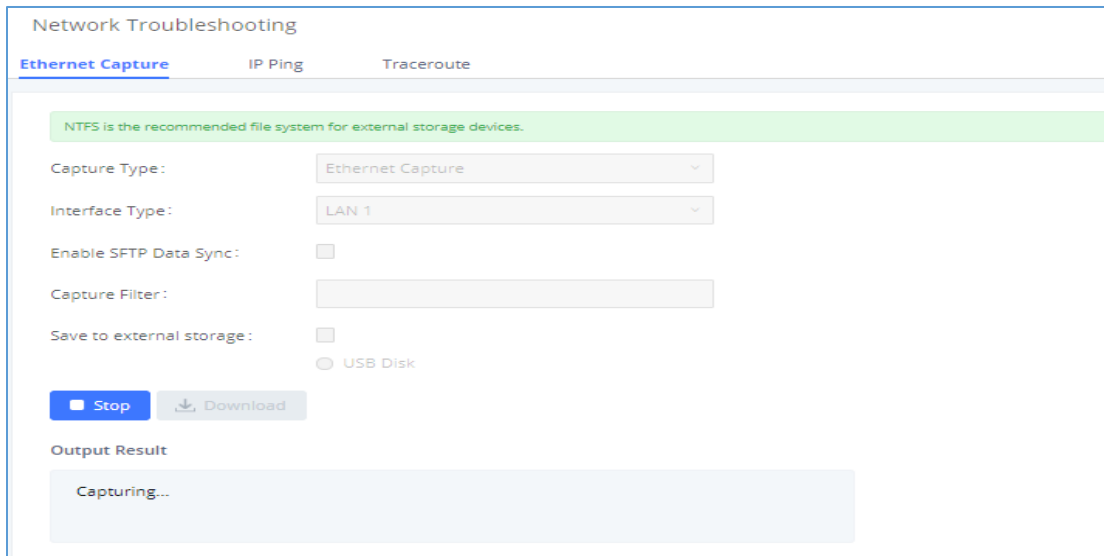


## Network Troubleshooting

The Network Troubleshooting page under Maintenance allows users to start network captures and ping/traceroute remote hosts.

### Ethernet Capture

Captured traces can be downloaded for analysis.



**Figure 341: Ethernet Capture**

**Table 162: Ethernet Capture**

<b>Interface Type</b>	Select the network interface to monitor.
<b>Enable SFTP Data Sync</b>	Check this box to save the capture files in the SFTP server. Please make sure the configuration of data synchronization works before.
<b>Capture Filter</b>	Enter the filter to obtain the specific types of traffic, such as (host, src, dst, net, proto...).
<b>Save to External Storage</b>	Check this box to activate storage of the capture either on the USB or SD Card.
<b>Start</b>	Click to start the trace.
<b>Stop</b>	Click to stop the trace.
<b>Download</b>	Click to download the trace if trace is stored locally.

The output result is in .tgz format, and users will need to use a compression tool such as WinRAR or 7-zip to unzip the .pcap file.

**Note:** Capture files saved on external devices will not have “capture” prepended to file names.



## IP Ping

Enter the hostname or IP address and click on the Start button. The ping process can be viewed from the Output Result window at the bottom of the page.

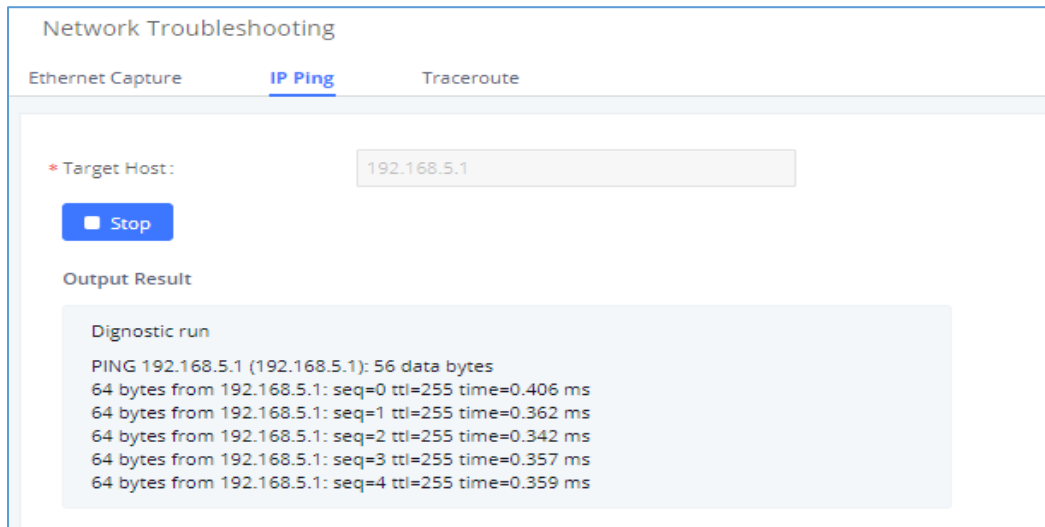


Figure 342: PING

## Traceroute

Enter the hostname or IP address and click on the Start button. The ping process can be viewed from the Output Result window at the bottom of the page.



Figure 343: Traceroute



## Signaling Troubleshooting

### PRI/SS7/MFC/R2 Signaling Trace

Please see section [\[Digital Trunk Troubleshooting\]](#).

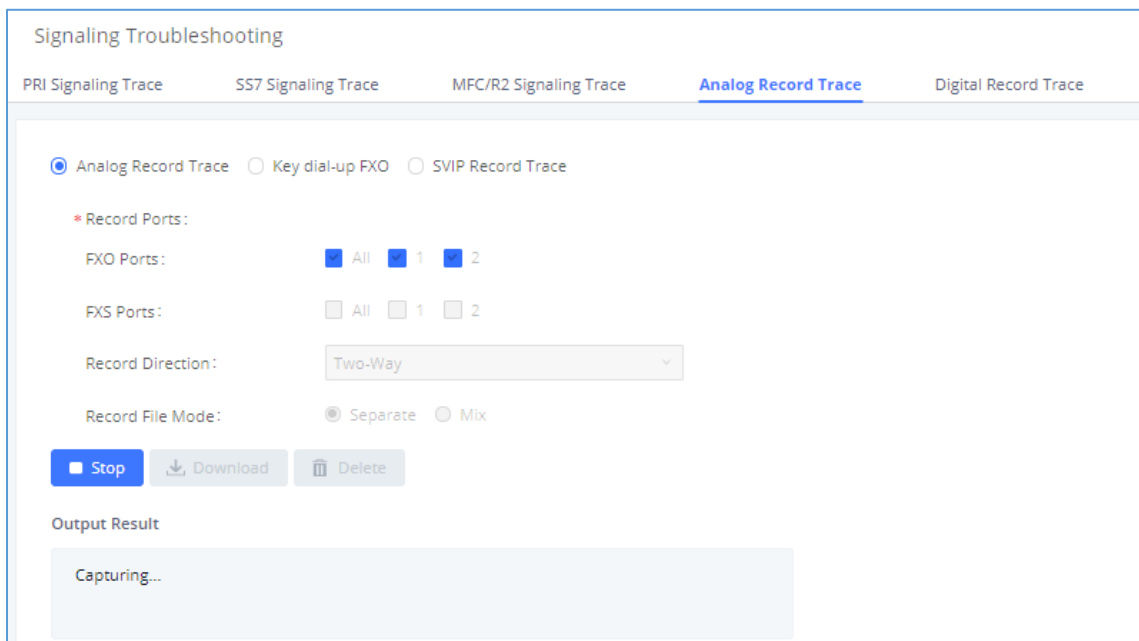
### Analog Record Trace

- **Analog Record Trace**

Analog record traces are used to troubleshoot analog trunk issues (e.g., CID detection for incoming calls from an analog trunk).

To capture analog record traces:

1. Select FXO or FXS for "Record Ports". If the issue happens on FXO 1, select FXO port 1 to record the trace.
2. Select "Record Direction".
3. Select "Record File Mode" to separate the record per direction or mix.
4. Click on "Start".
5. Make a call via the analog port that has the issue.
6. Once done, click on "Stop".
7. Click on "Download" to download the analog record trace.



The screenshot shows the "Signaling Troubleshooting" interface with the "Analog Record Trace" tab selected. The configuration options are as follows:

- Record Ports:**
  - FXO Ports:  All,  1,  2
  - FXS Ports:  All,  1,  2
- Record Direction:** Two-Way (dropdown menu)
- Record File Mode:**  Separate,  Mix

Buttons: Stop, Download, Delete

**Output Result:** Capturing...

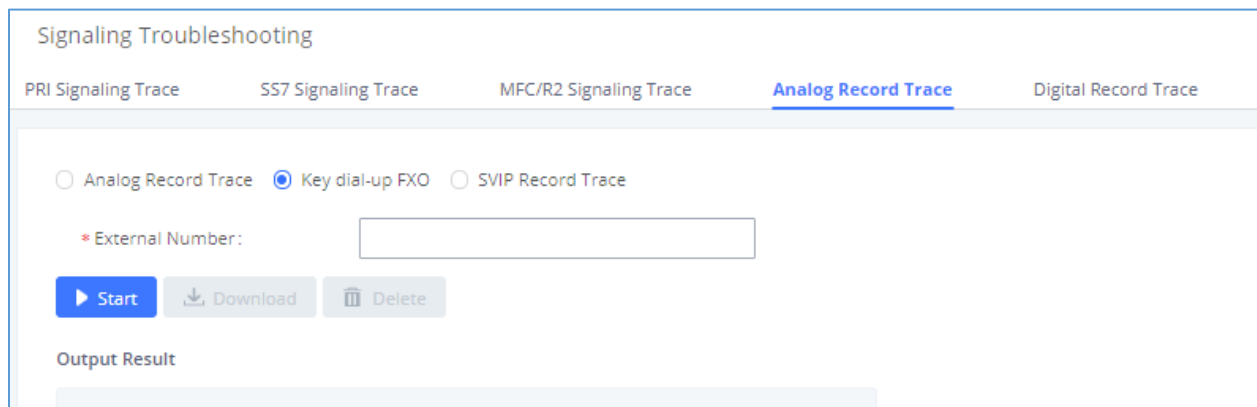
Figure 344: Troubleshooting Analog Trunks



- **Key Dial-up FXO**

Users can configure a PSTN number in the External Number field to send test calls to and troubleshoot issues related to the used analog trunk. To use this:

1. Configure analog trunk on UCM, including outbound route.
2. Enter a reachable external number in “**External Extension**”.
3. Press “**Start**” button. The call will be initiated to the external number.
4. Answer and finish the call before pressing “Stop” button.
5. The trace will be available for analysis to download after output result shows “Done! Click on Download to download the captured packets”.



**Figure 345: A Key Dial-up FXO**

**Note:** To use Key dial-up FXO troubleshooting, the outbound route for the analog trunk must have permission set to "Internal" and must have the highest priority for the external number used for troubleshooting. After capturing the trace, users can download it for basic analysis. If further assistance is necessary, please contact Grandstream Technical Support using the following link:

<http://www.grandstream.com/support>

- **SVIP Record Trace**

Users can capture an SVIP record trace for specific FXO/FXS ports.

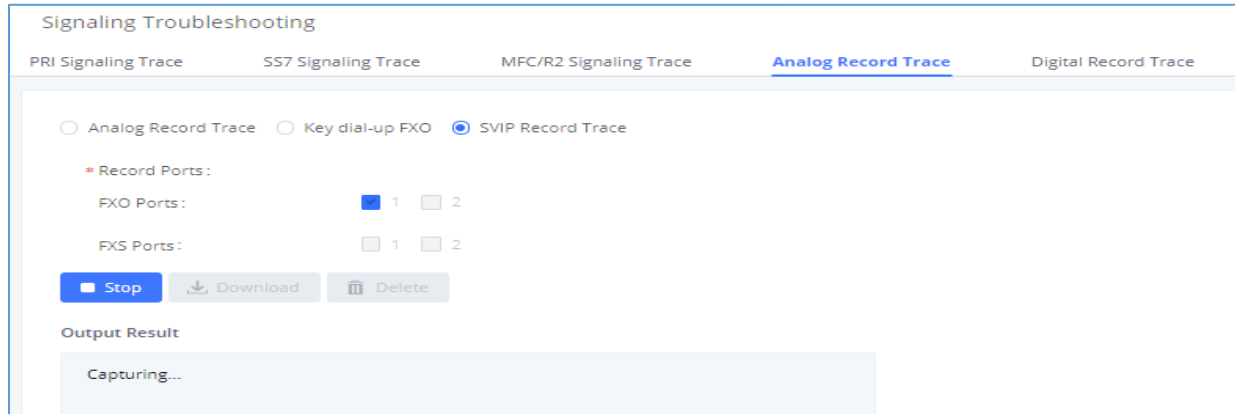


Figure 346: SVIP Record Trace

## E&M Immediate Record Trace

To capture an E&M record trace, navigate to Signaling Troubleshooting->Digital Record Trace and configure the Record Direction and Record File Mode options to the desired values. Click on the Start button to start capturing.

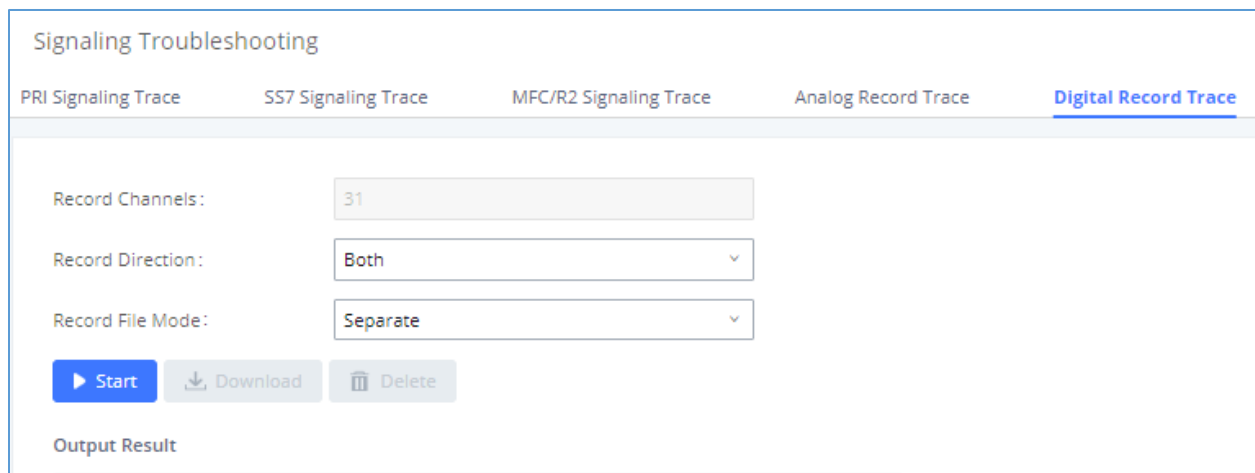


Figure 347: E&M Immediate Record Trace

## Service Check

**Service Check** will cause the UCM to periodically send SIP OPTIONS to the Asterisk server to check on functionality.

**Check Cycle** is the frequency (in seconds) at which to check the Asterisk server for issues.

**Check Times** is the maximum number of failed checks that can occur before the UCM is restart, and a coredump file is generated. Generated coredump files can be sent to Grandstream Technical Support for analysis and troubleshooting.



### Service Check

Enable Server Check:

\* Check Cycle:

\* Check times:

**Figure 348: Service Check**

## Network Status

Users can navigate to **System Status**→**Network Status** to view the UCM's active network connections. If users are experiencing connection issues to specific services, they can view this page for troubleshooting.

Network Status					
Active Internet Connections (Servers And Established)					
Proto	Recv-Q	Send-Q	Local-Address	Foreign-Address	State
tcp	0	0	0.0.0.7681	0.0.0.0*	LISTEN
tcp	0	0	0.0.0.7777	0.0.0.0*	LISTEN
tcp	0	0	0.0.0.389	0.0.0.0*	LISTEN
tcp	0	0	0.0.0.2000	0.0.0.0*	LISTEN
tcp	0	0	0.0.0.8888	0.0.0.0*	LISTEN
Active Unix Domain Sockets (Servers And Established)					
Proto	RefCnt	Flags	Type	State	I-Node
unix	2	[ACC]	STREAM	LISTENING	8487
unix	2	[ACC]	STREAM	LISTENING	8491
unix	2	[ACC]	STREAM	LISTENING	8494
unix	2	[ACC]	STREAM	LISTENING	8498
unix	2	[ACC]	STREAM	LISTENING	8501

**Figure 349: Network Status**



## EXPERIENCING THE UCM6510 SERIES IP PBX

Please visit our website: <http://www.grandstream.com> to receive the most up- to-date updates on firmware releases, additional features, FAQs, documentation and news on new products.

We encourage you to browse our [product related documentation](#), [FAQs](#) and [User and Developer Forum](#) for answers to your general questions. If you have purchased our products through a Grandstream Certified Partner or Reseller, please contact them directly for immediate support.

Our technical support staff is trained and ready to answer all of your questions. Contact a technical support member or [submit a trouble ticket online](#) to receive in-depth support.

Thank you again for purchasing Grandstream UCM6510 IP PBX appliance, it will be sure to bring convenience and color to both your business and personal life.

**\* Asterisk is a Registered Trademark of Digium, Inc.**

